

1:	10.4	↑
2:	10.4	↗
3:	10.1	↗
4:	*10.8	→
5:	*10.8	↗
Serie		50.0
Total		0.0

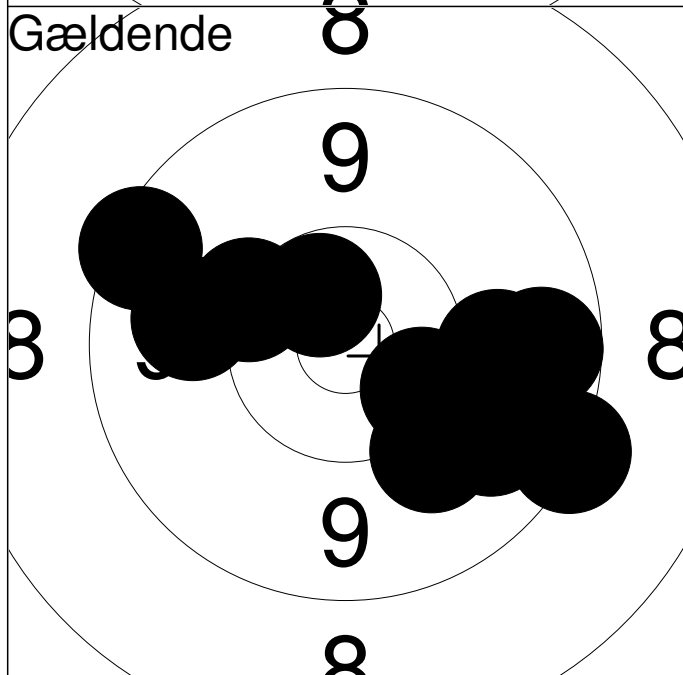

1:	9.9	→
2:	9.6	→
3:	10.2	↗
4:	*10.6	↗
5:	10.4	↘
6:	9.2	↘
7:	9.8	↘
8:	9.4	↗
9:	10.0	↘
10:	9.9	↗
Serie		94.0
Total		94.0

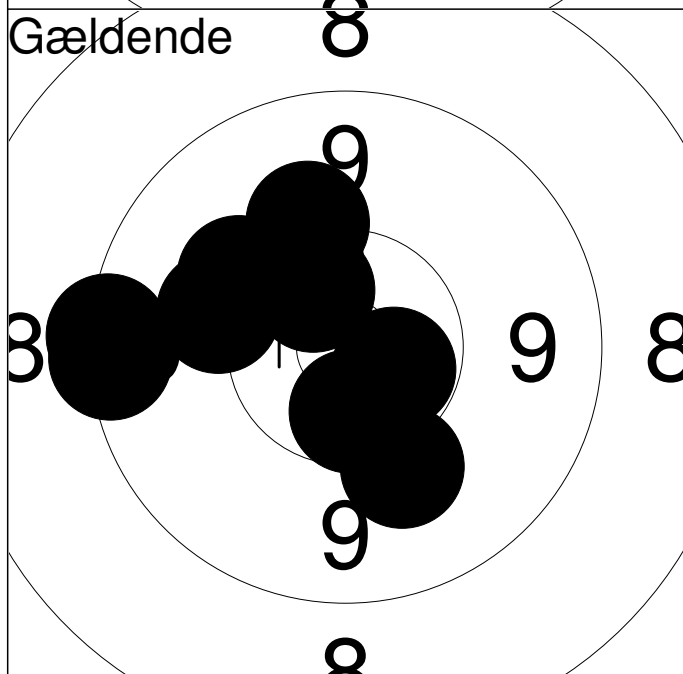

11:	9.3	←
12:	*10.5	↗
13:	10.1	↗
14:	10.1	↖
15:	*10.5	←
16:	9.3	↗
17:	10.1	↗
18:	*10.6	↘
19:	10.3	↗
20:	10.1	↗
Serie		98.0
Total		192.0

Prøveskud

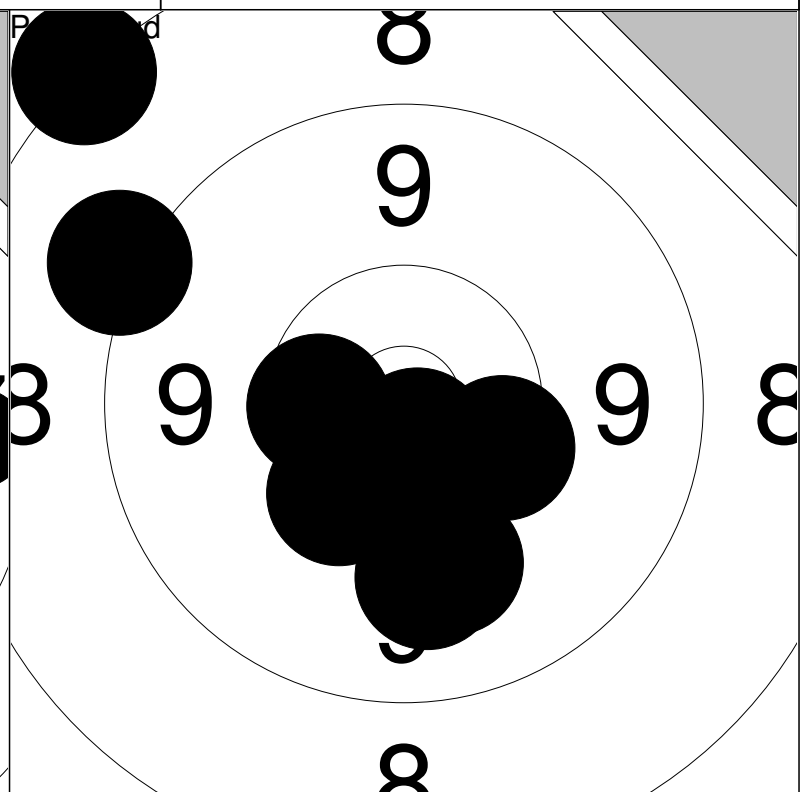
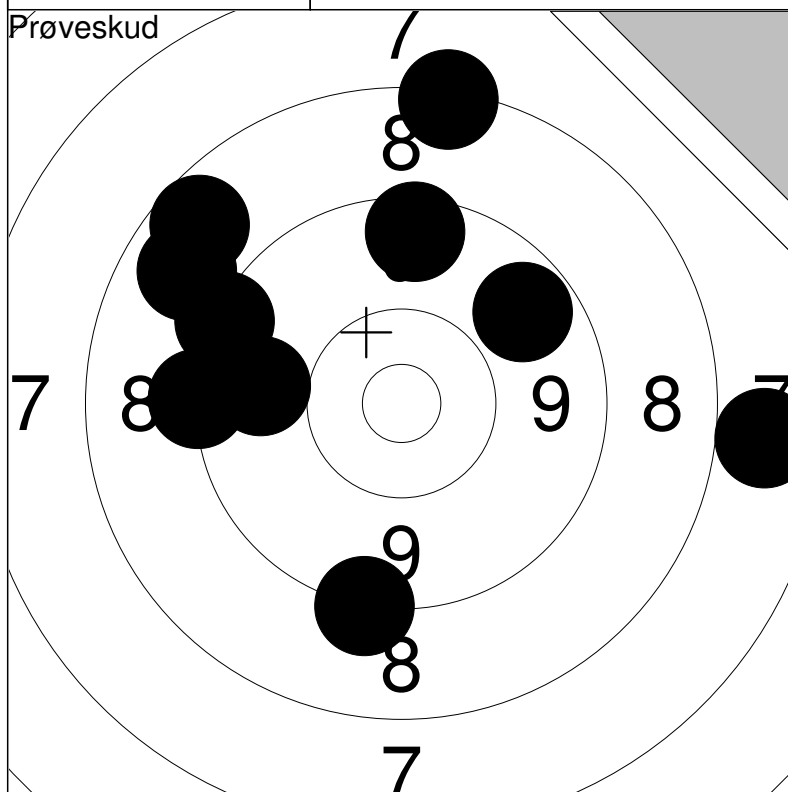

1: 9.2	↓	6: 9.7	↗	Serie	85.0
2: 8.6	↖	7: 9.7	←		
3: 9.2	←	8: 9.3	←	Total	0.0
4: 8.8	↗	9: 8.2	↑		
5: 9.5	↑	10: 7.7	→		

11: 10.3	→	16: 8.2	↖	Serie	76.0
12: 10.3	↘	17: 9.9	↓		
13: 9.1	↖	18: *10.7	↘	Total	0.0
14: *10.5	←				
15: 10.0	↓				

Gældende

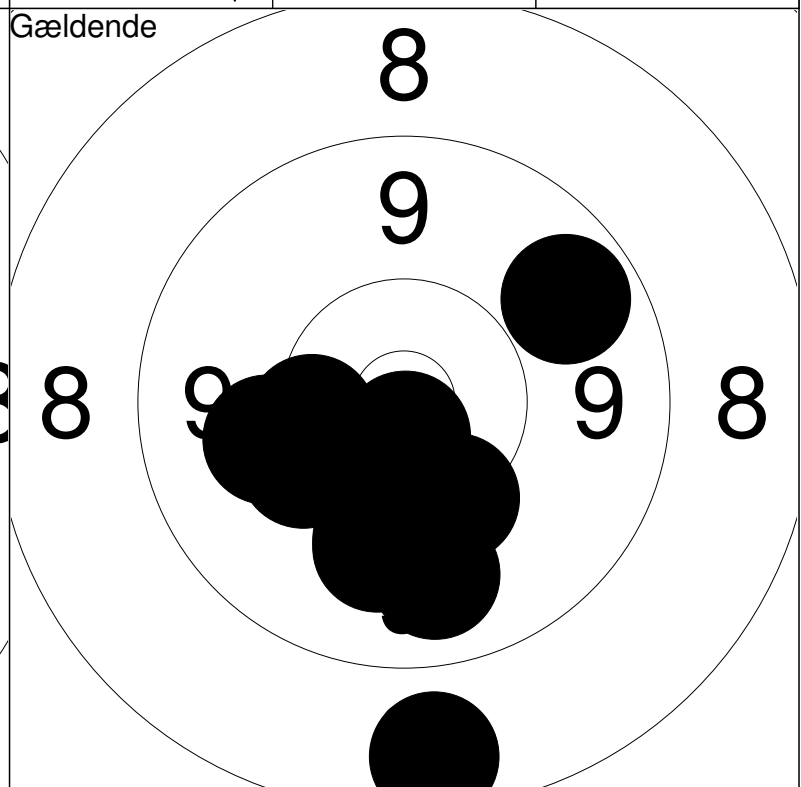
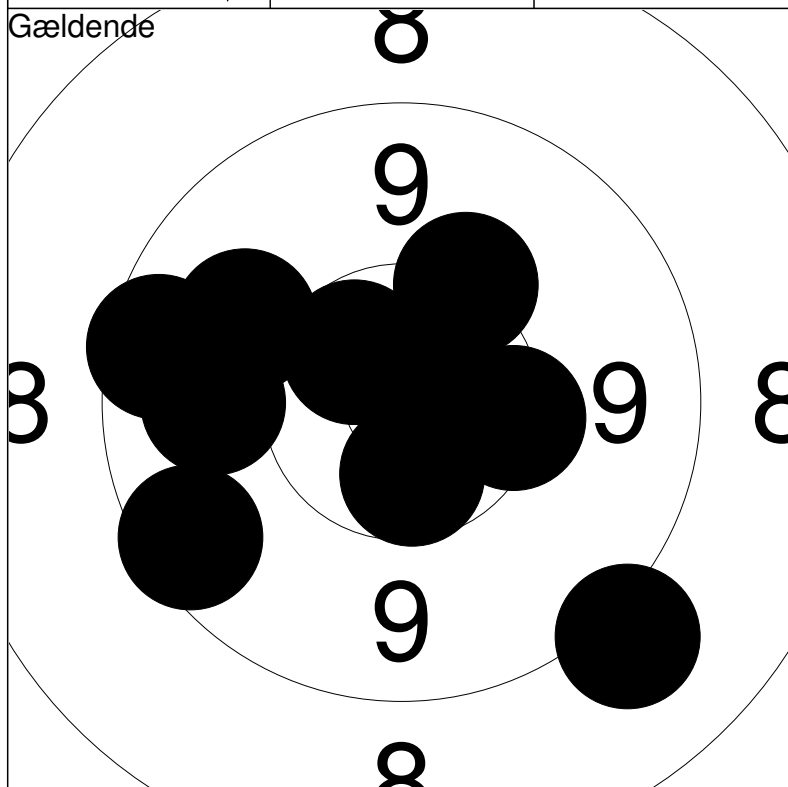

1: *10.6	↗	6: *10.5	↓	Serie	95.0
2: 9.0	↘	7: 9.5	←		
3: 9.9	↖	8: 9.5	←	Total	95.0
4: 9.9	←	9: 10.3	→		
5: 10.2	↗	10: *10.7	→		

11: 10.0	↓	16: 10.0	↓	Serie	96.0
12: 10.3	←	17: 10.0	←		
13: 9.7	↗	18: 8.5	↓	Total	191.0
14: 10.2	↘	19: 10.2	←		
15: 9.8	↓	20: *10.7	↓		

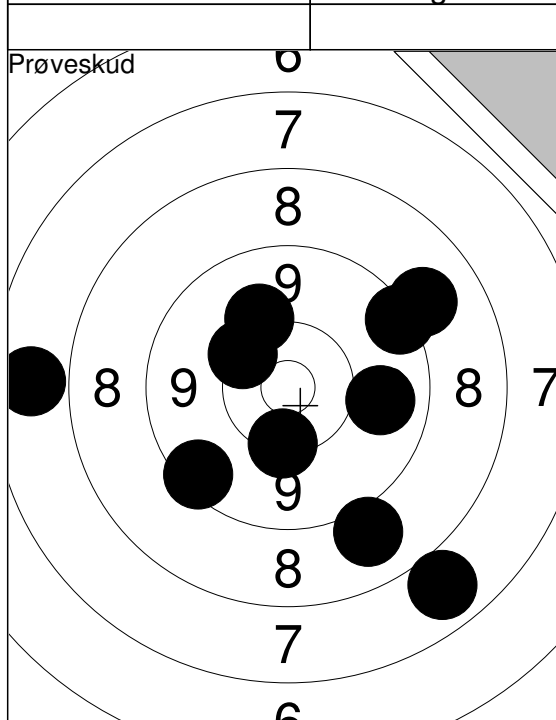

Serie	87.0
Total	0.0

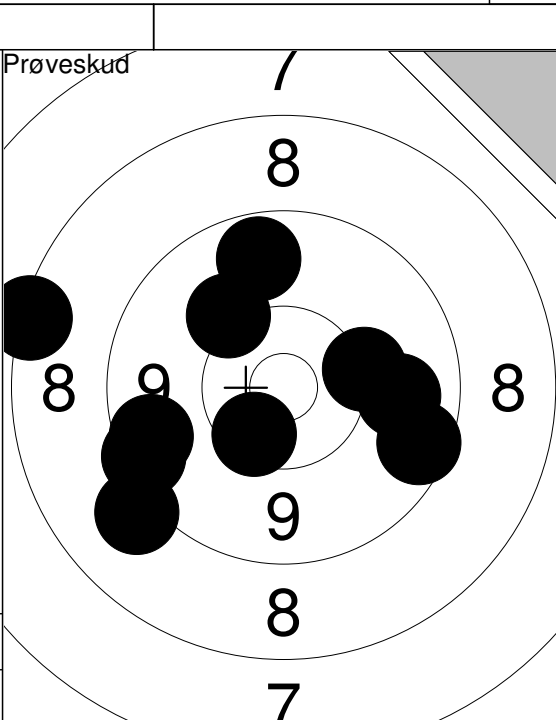

Serie	92.0
Total	0.0

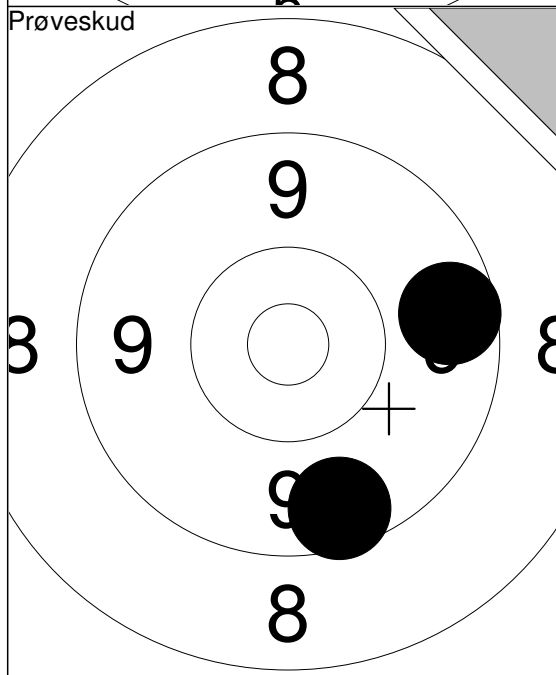

Serie	18.0
Total	0.0

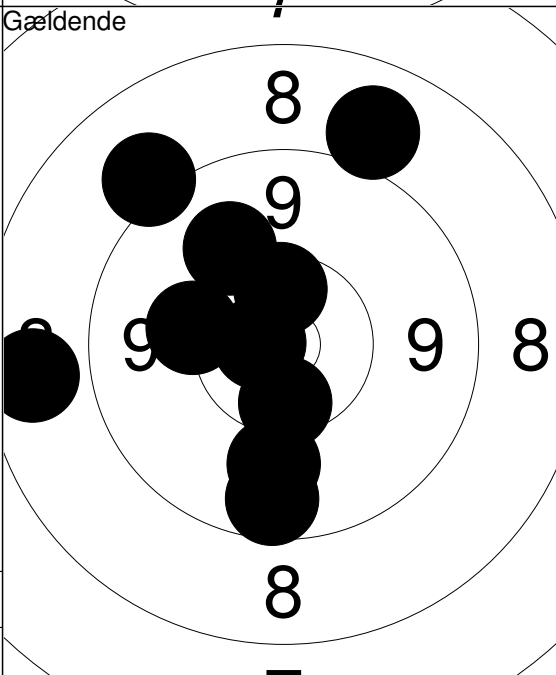

Serie	93.0
Total	93.0

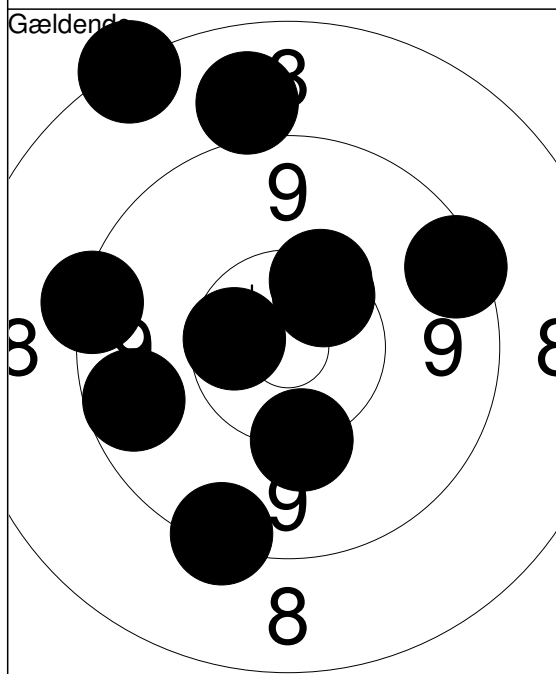

Serie	92.0
Total	185.0

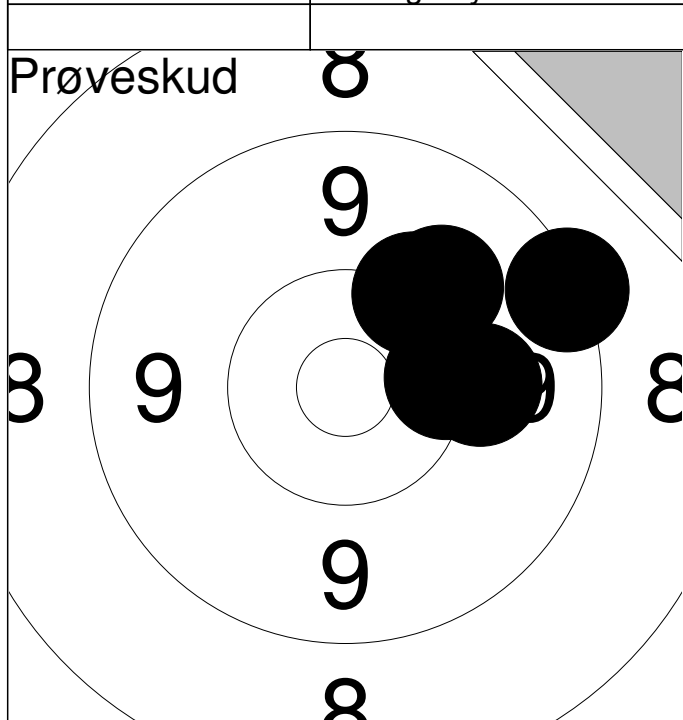

1:	9.3	→
2:	10.0	↗
3:	10.3	→
4:	10.0	→
5:	10.2	↗
Serie		49.0
Total		0.0

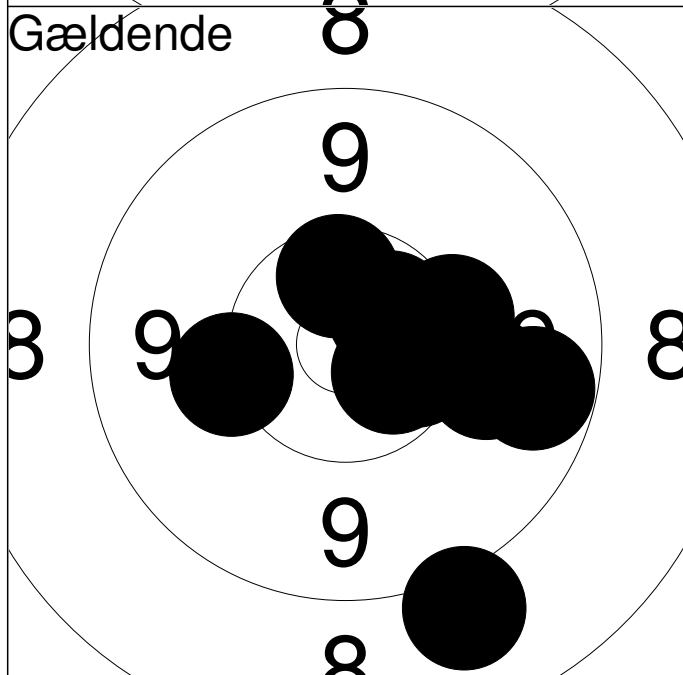

1:	10.2	←
2:	*10.5	→
3:	9.6	→
4:	*10.6	↗
5:	10.0	→
6:	*10.6	↘
7:	*10.5	→
8:	10.2	→
9:	*10.5	↑
10:	8.9	↓
Serie		97.0
Total		97.0

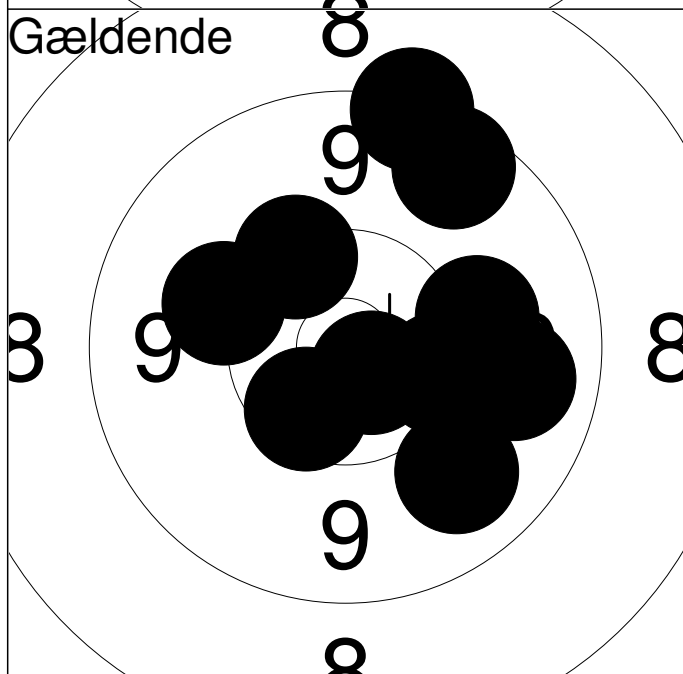

11:	*10.7	↘
12:	9.2	↑
13:	10.3	→
14:	10.1	↖
15:	9.5	↗
16:	10.0	→
17:	10.3	↗
18:	*10.5	↘
19:	9.8	→
20:	9.8	↘
Serie		96.0
Total		193.0

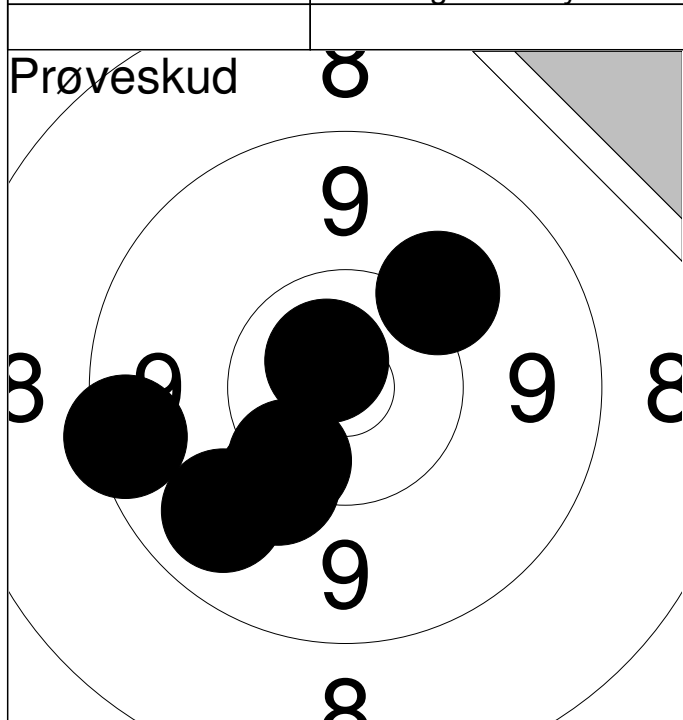

	1:	9.4	←
	2:	10.2	↙
	3:	10.1	↗
	4:	9.8	↙
	5:	10.3	↙
	6:	*10.7	↗
Serie			58.0
Total			0.0

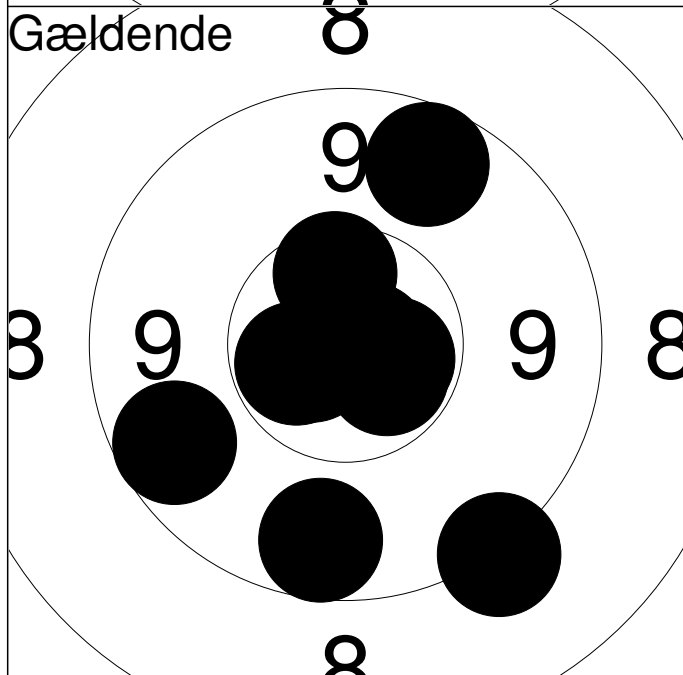

	1:	*10.6	←
	2:	9.6	↗
	3:	9.6	↙
	4:	9.1	↘
	5:	*10.6	↘
	6:	*10.7	↙
	7:	*10.5	↗
	8:	*10.6	↘
	9:	9.6	↘
	10:	*10.8	→
Serie			96.0
Total			96.0

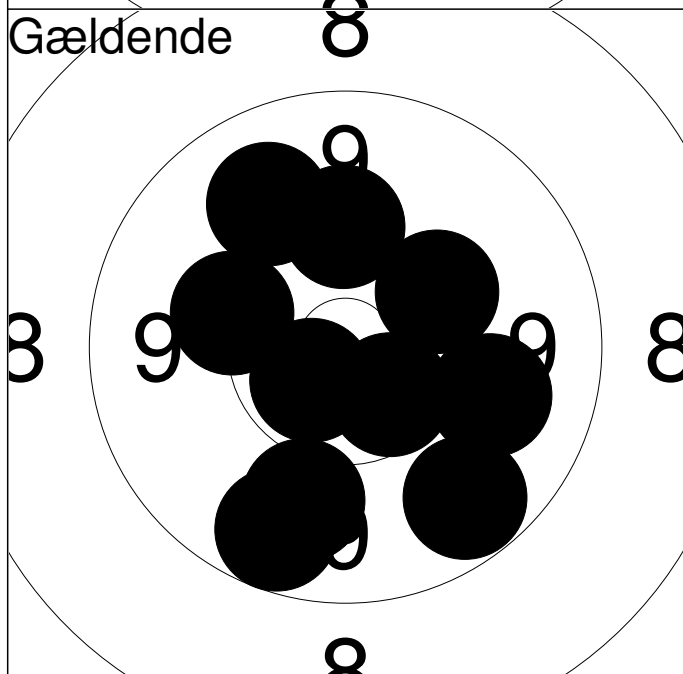

	11:	9.9	↘
	12:	10.2	←
	13:	10.1	↗
	14:	*10.5	↘
	15:	9.6	↘
	16:	*10.6	↙
	17:	10.2	↗
	18:	9.6	↘
	19:	9.9	→
	20:	9.9	↗
Serie			95.0
Total			191.0

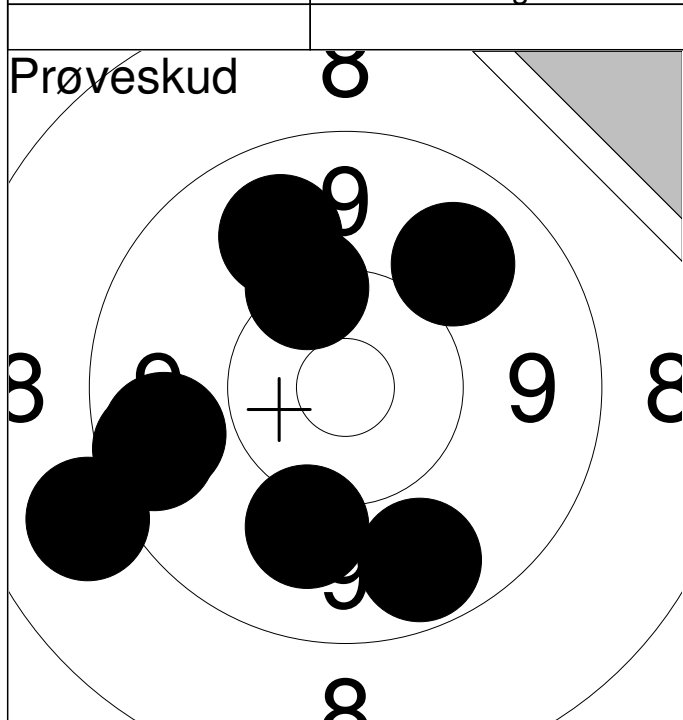

1:	8.9	↙
2:	9.8	↗
3:	9.7	↙
4:	9.6	↙
5:	9.7	↘
6:	10.0	↘
7:	10.2	↗
8:	9.8	↗
Serie		73.0
Total		0.0

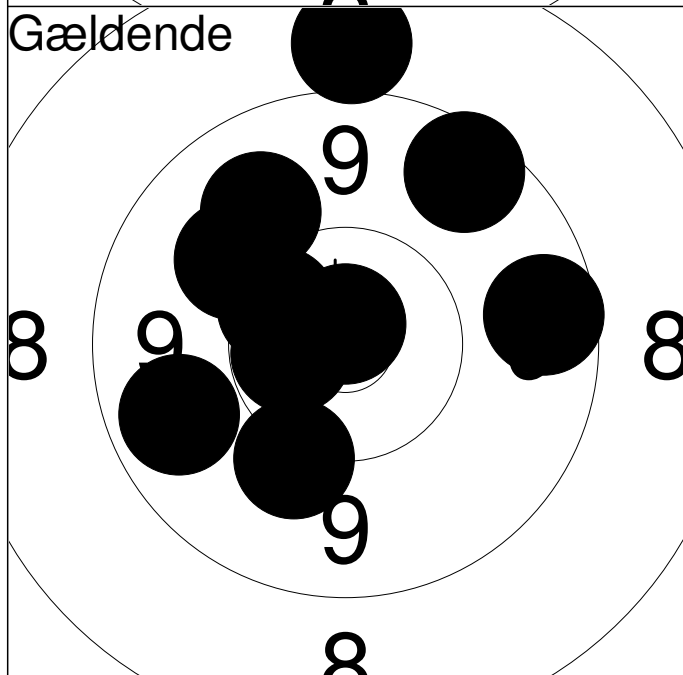

1:	9.9	↗
2:	9.6	→
3:	*10.4	↗
4:	9.5	↗
5:	10.0	↗
6:	*10.6	↙
7:	9.7	↙
8:	*10.8	↑
9:	8.8	↑
10:	10.1	↘
Serie		94.0
Total		94.0

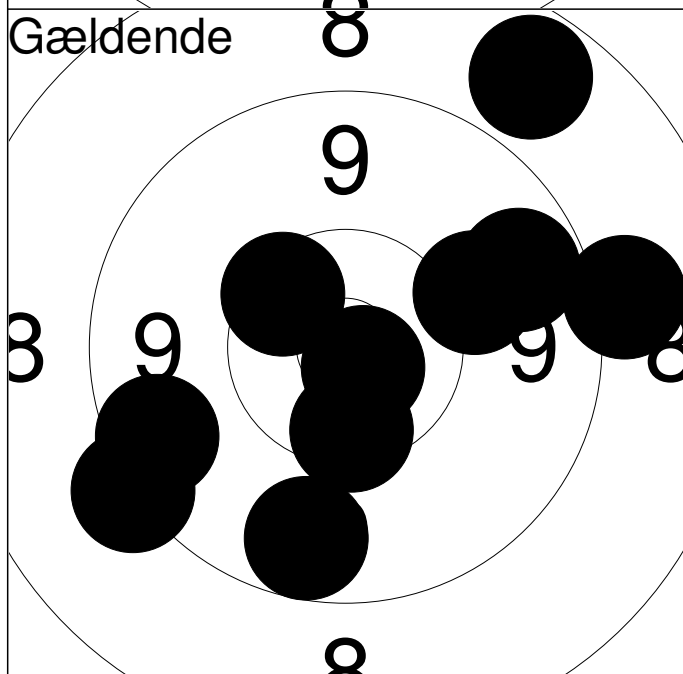

11:	9.7	→
12:	10.4	↖
13:	9.5	↙
14:	9.0	→
15:	9.6	↘
16:	10.4	↘
17:	9.2	↙
18:	10.0	→
19:	8.7	↗
20:	*10.8	↘
Serie		93.0
Total		187.0

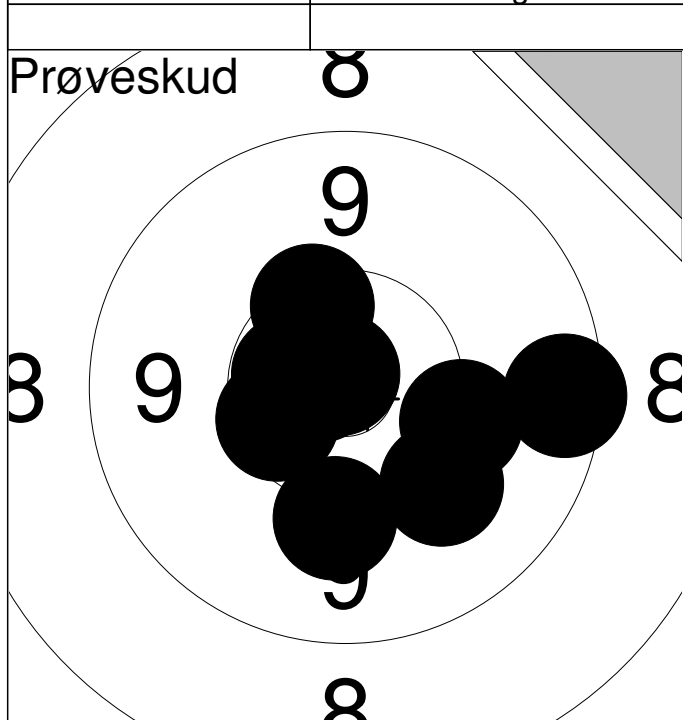

1:	10.0	↘
2:	*10.4	←
3:	*10.6	↑
4:	*10.8	↑
5:	10.1	↙
6:	10.4	↗
7:	10.1	↘
8:	9.4	→
9:	*10.8	↗
Serie		89.0
Total		0.0

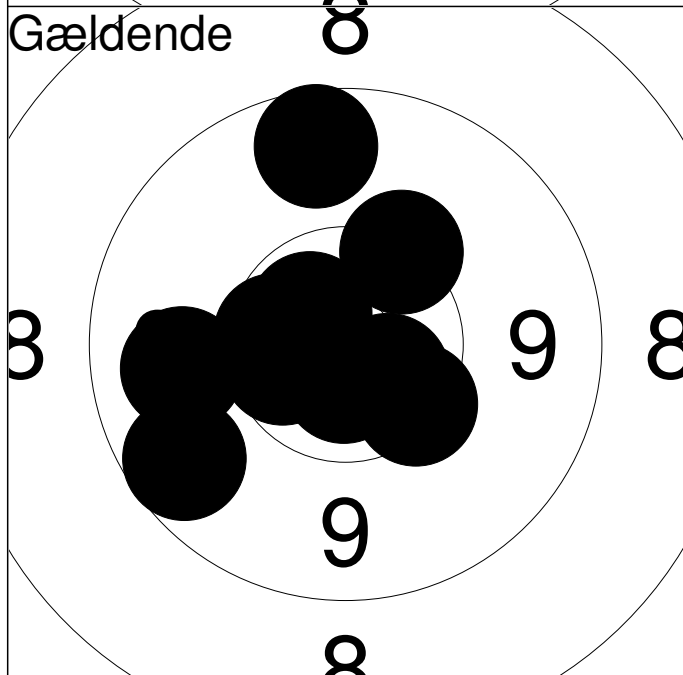

1:	10.2	↗
2:	9.6	←
3:	*10.6	↗
4:	10.3	↘
5:	*10.5	←
6:	9.8	←
7:	*10.6	↘
8:	*10.7	↘
9:	9.6	↑
10:	*10.5	←
Serie		97.0
Total		97.0

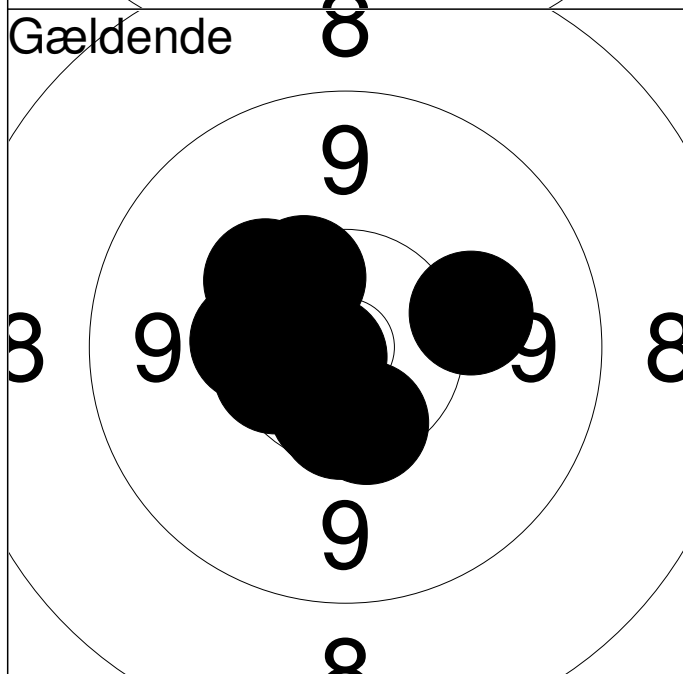

11:	*10.8	←
12:	10.1	→
13:	*10.4	←
14:	10.4	↗
15:	10.3	←
16:	*10.5	↙
17:	10.4	↗
18:	*10.4	↘
19:	*10.5	↘
20:	10.3	↗
Serie		100.0
Total		197.0

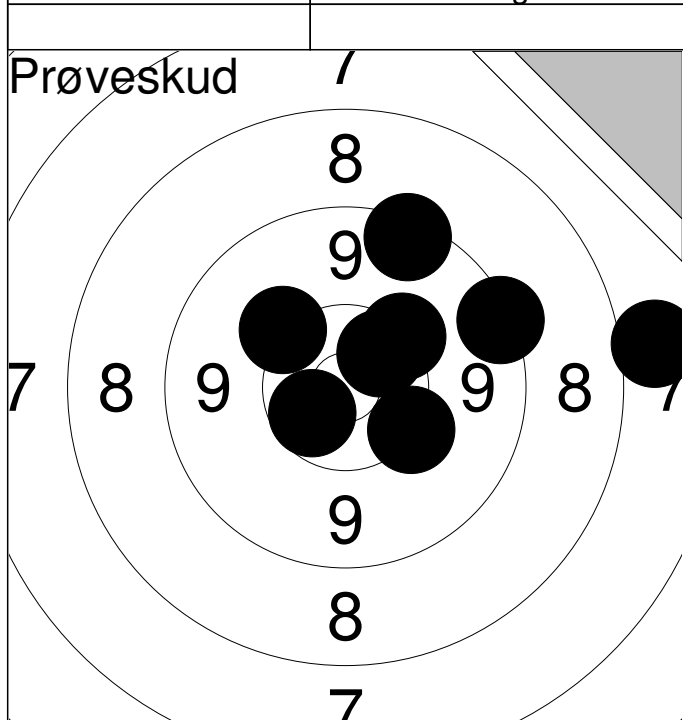

1:	10.2	↗
2:	*10.5	↖
3:	10.1	↗
4:	*10.5	↗
5:	7.8	→
6:	9.4	↑
7:	9.3	↗
8:	10.2	↘
Serie		75.0
Total		0.0

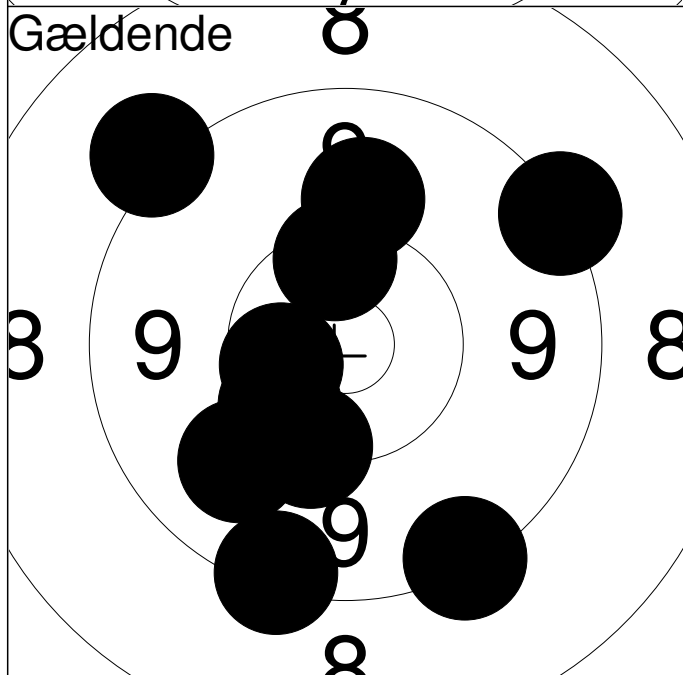

1:	9.1	↖
2:	9.2	↗
3:	10.4	↑
4:	*10.5	↖
5:	10.3	↘
6:	9.3	↘
7:	9.9	↖
8:	10.0	↑
9:	10.2	↘
10:	9.3	↘
Serie		95.0
Total		95.0

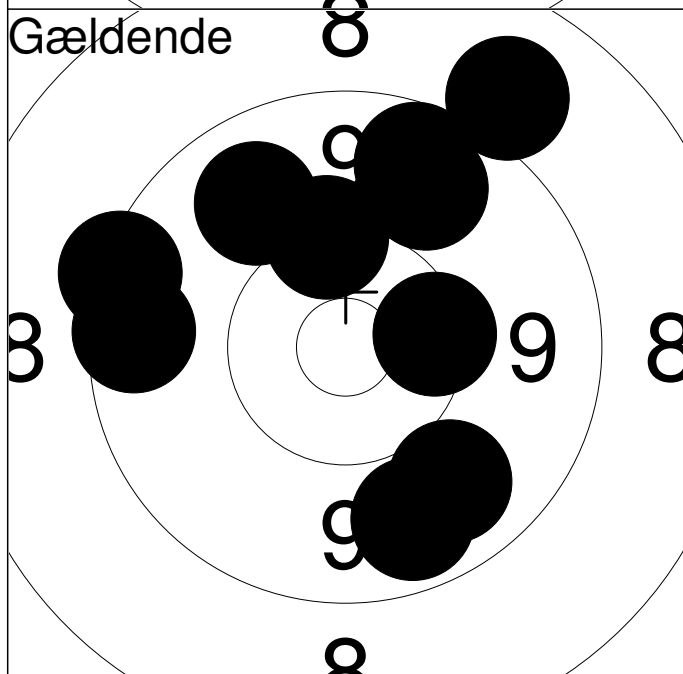

11:	9.7	↗
12:	8.9	↗
13:	9.3	↖
14:	10.2	↗
15:	10.3	→
16:	9.6	↗
17:	9.8	↘
18:	9.5	↖
19:	9.8	↗
20:	9.7	↘
Serie		91.0
Total		186.0

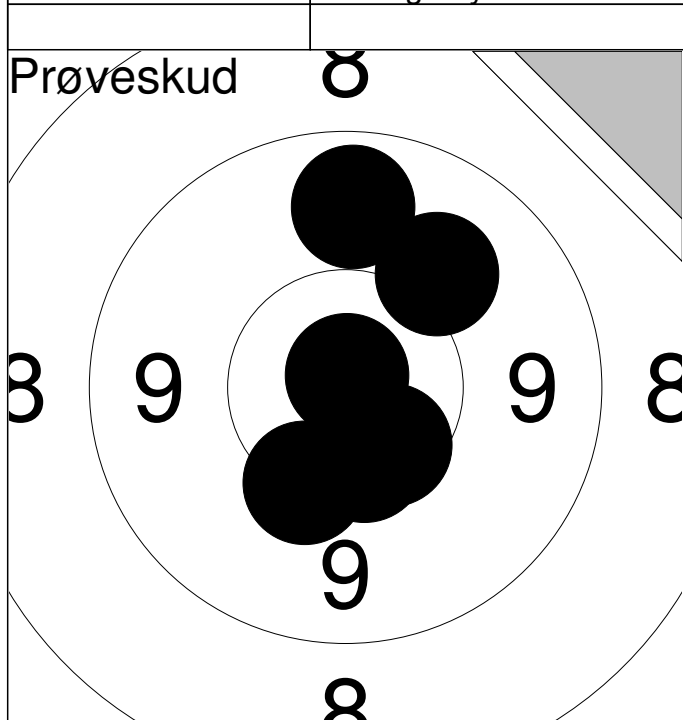

1:	9.7	↑
2:	*10.4	↓
3:	10.3	↙
4:	10.0	↗
5:	*10.5	↓
6:	*10.9	↑
Serie		59.0
Total		0.0

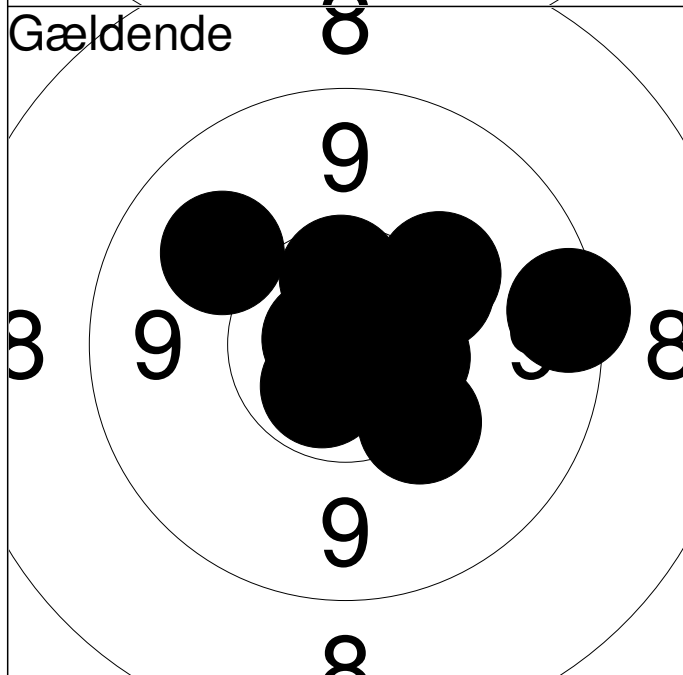

1:	*10.8	↗
2:	9.9	↗
3:	9.4	→
4:	*10.6	↙
5:	*10.5	→
6:	*10.5	↑
7:	10.3	↗
8:	10.2	↗
9:	10.2	↓
10:	*10.8	↖
Serie		98.0
Total		98.0

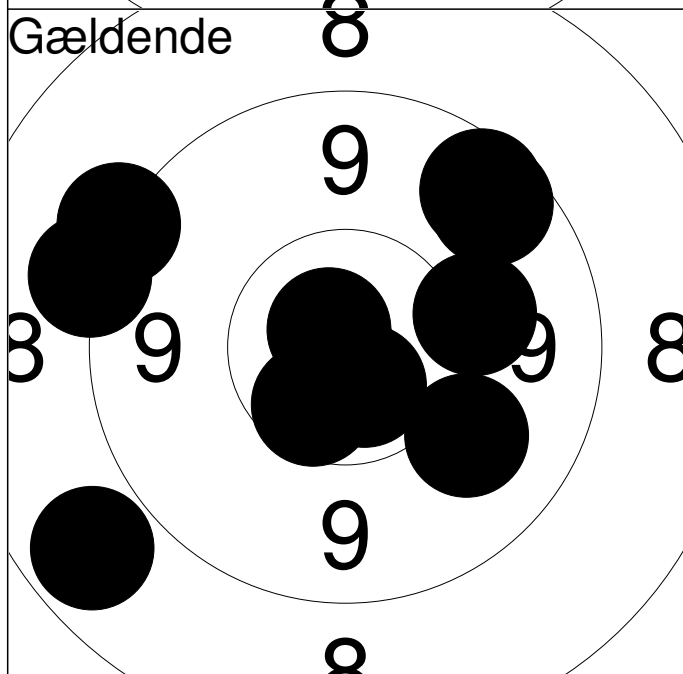

11:	*10.8	↗
12:	10.1	→
13:	9.9	↓
14:	*10.7	↙
15:	9.1	↖
16:	9.2	↖
17:	9.5	↗
18:	9.6	↗
19:	*10.5	↙
20:	8.7	↙
Serie		93.0
Total		191.0

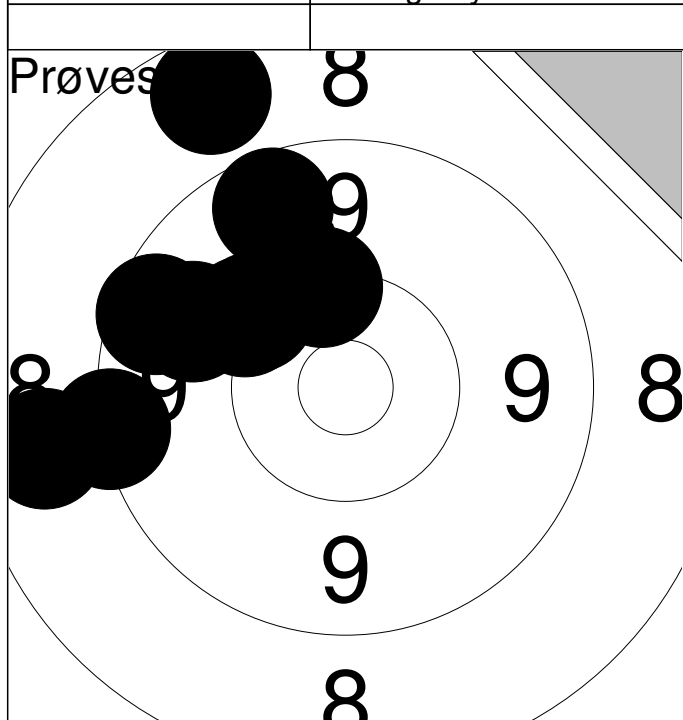

1:	8.6	↗
2:	9.6	↗
3:	9.2	↖
4:	10.1	↗
5:	9.8	↗
6:	8.7	↖
7:	10.1	↗
8:	9.5	↗
9:	10.2	↗
Serie		82.0
Total		0.0

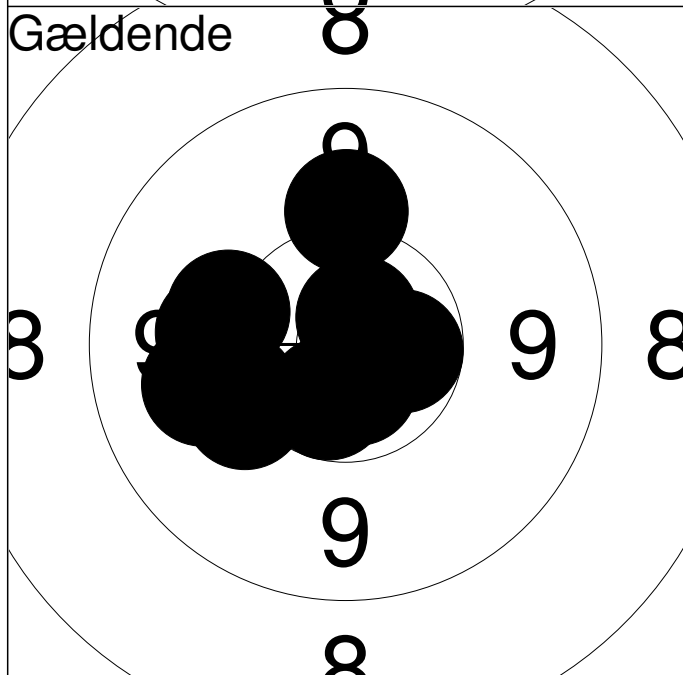

1:	10.1	↖
2:	10.1	↗
3:	10.0	↖
4:	*10.6	↘
5:	10.1	↖
6:	*10.7	↘
7:	10.2	↖
8:	10.1	↗
9:	*10.6	→
10:	*10.7	↗
Serie		100.0
Total		100.0

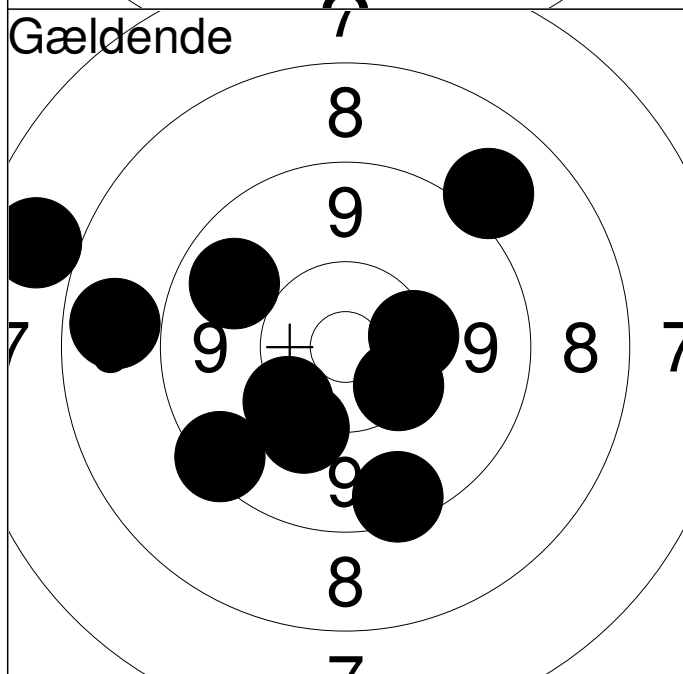

11:	8.9	↗
12:	9.4	↘
13:	9.7	↗
14:	9.4	↖
15:	10.3	→
16:	10.3	↘
17:	7.8	↗
18:	10.2	↖
19:	10.1	↘
20:	8.7	↖
Serie		90.0
Total		190.0

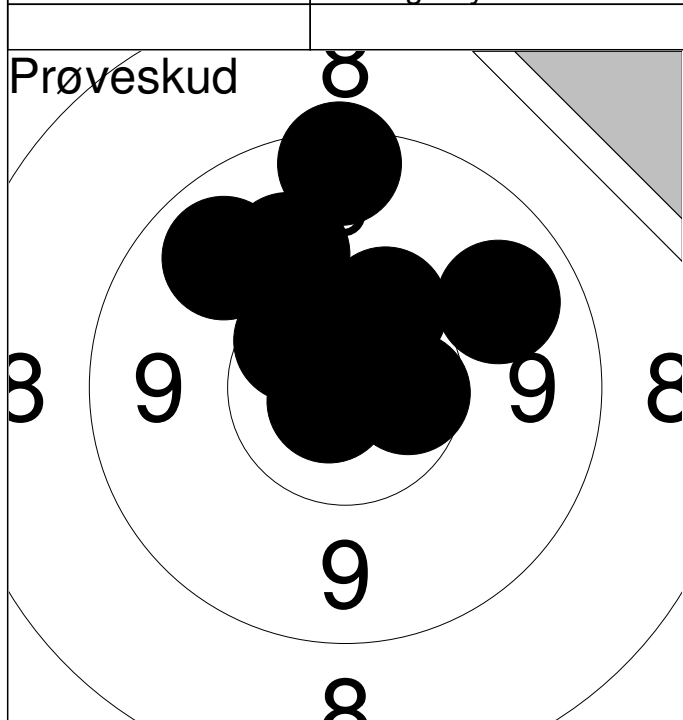

1:	*10.5	→
2:	10.0	↗
3:	9.4	↑
4:	9.7	↖
5:	10.4	↑
6:	*10.8	↙
7:	9.8	↗
8:	*10.5	↖
Serie		77.0
Total		0.0

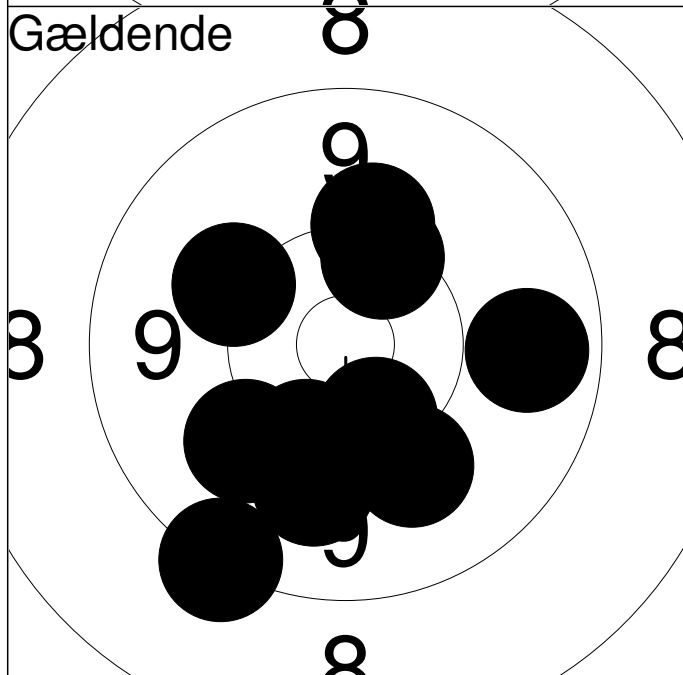

1:	10.1	↖
2:	10.0	↓
3:	10.0	↙
4:	9.7	→
5:	10.4	↓
6:	10.0	↓
7:	9.2	↙
8:	10.2	↓
9:	10.3	↑
10:	10.1	↑
Serie		98.0
Total		98.0

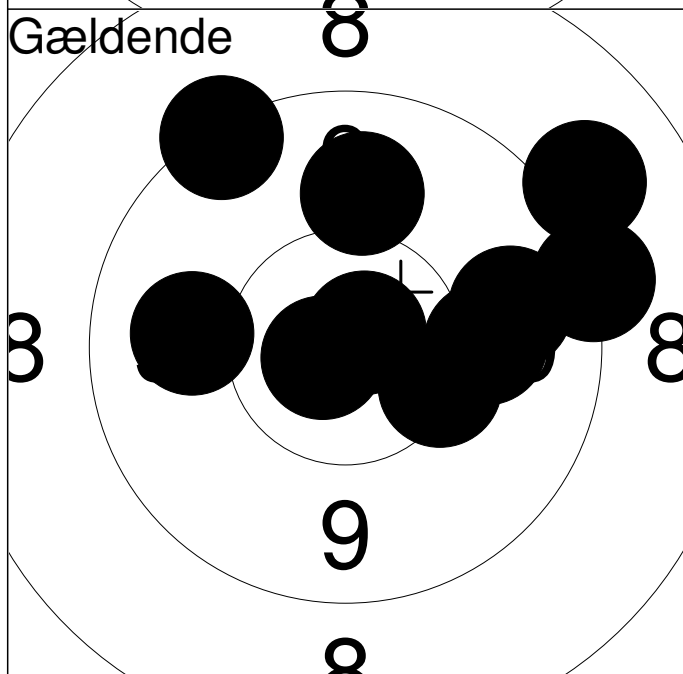

11:	*10.8	↙
12:	9.8	→
13:	8.9	↗
14:	9.3	↖
15:	*10.8	↗
16:	9.9	←
17:	10.3	→
18:	9.9	↑
19:	9.2	→
20:	10.0	→
Serie		93.0
Total		191.0

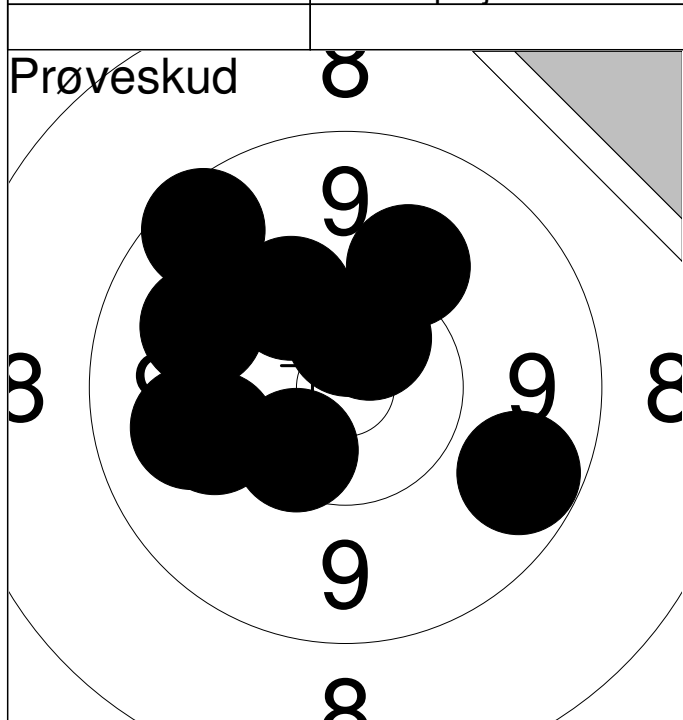

1:	10.0		←
2:	*10.4		↙
3:	9.9		←
4:	10.2		↗
5:	9.9		↗
6:	*10.6		↗
7:	9.5		↗
8:	*10.6		↗
9:	10.0		↗
10:	9.6		↘
Serie			96.0
Total			0.0

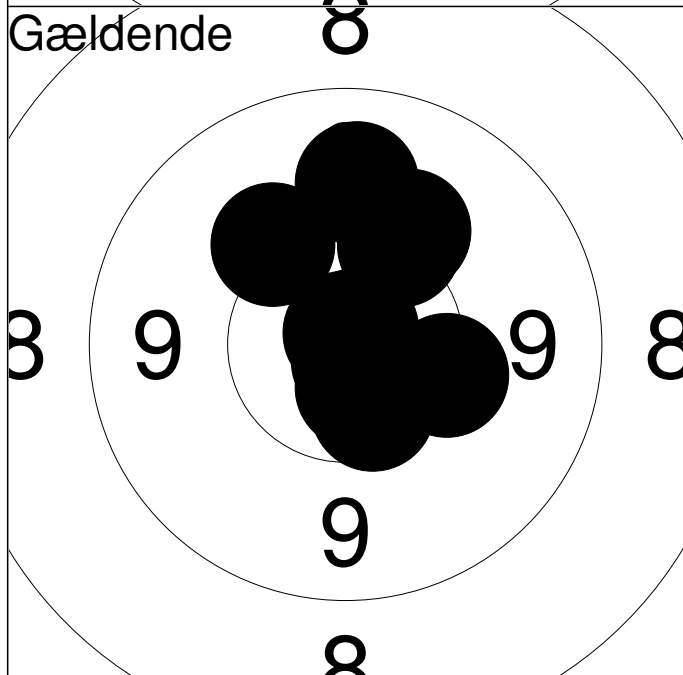

1:	*10.5		↘
2:	10.2		↗
3:	10.1		↗
4:	*10.9		↗
5:	9.9		↗
6:	10.2		↘
7:	10.1		↗
8:	*10.8		↗
9:	*10.8		↘
10:	*10.7		↘
Serie			99.0
Total			99.0

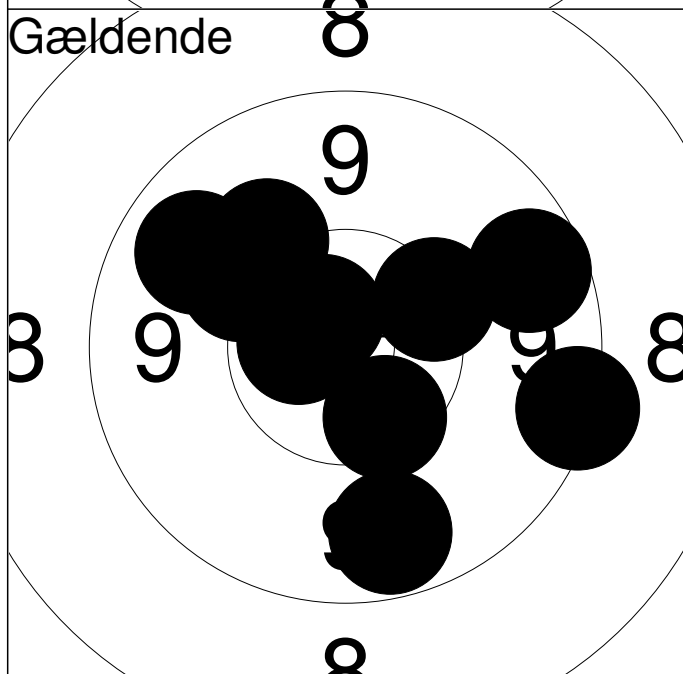

11:	9.6		→
12:	9.3		↘
13:	10.1		↗
14:	10.1		↗
15:	9.6		↙
16:	9.8		↗
17:	*10.6		←
18:	10.4		↙
19:	10.3		↗
20:	*10.7		↗
Serie			96.0
Total			195.0

Prøveskud

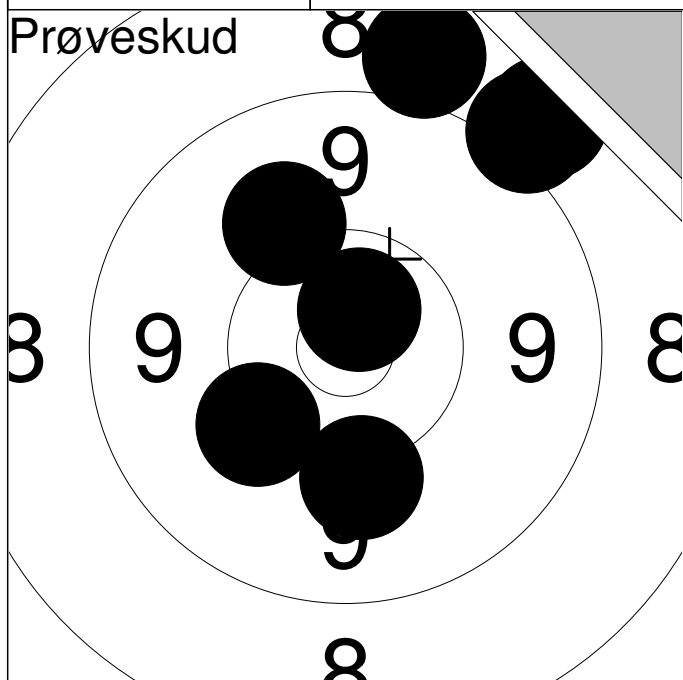

1:	8.8	↑
2:	8.8	↗
3:	9.0	↗
4:	10.1	↓
5:	10.2	↙
6:	10.0	↗
7:	*10.7	↗
Serie		65.0
Total		0.0

Gældende

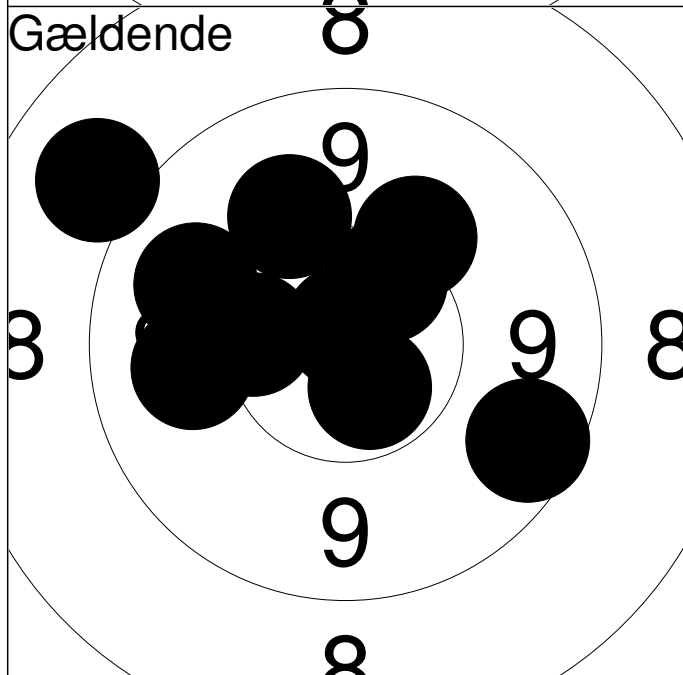

1:	10.1	↗
2:	10.0	↗
3:	*10.6	↓
4:	9.9	←
5:	8.9	↗
6:	9.9	↗
7:	*10.4	↗
8:	10.3	←
9:	*10.8	↑
10:	9.5	↓
Serie		95.0
Total		95.0

Gældende

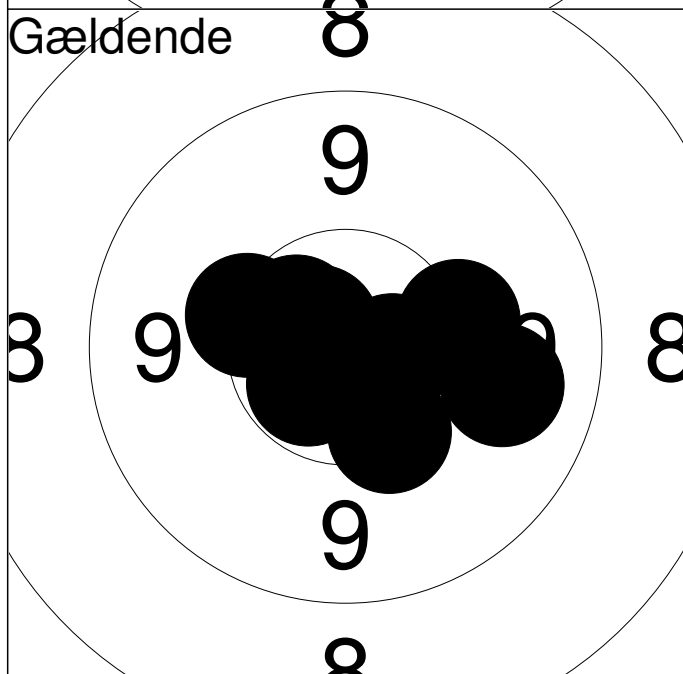

11:	*10.6	↙
12:	*10.6	↗
13:	9.9	→
14:	*10.8	↙
15:	10.2	→
16:	*10.6	→
17:	10.3	↙
18:	*10.7	↗
19:	10.3	↗
20:	*10.7	↙
Serie		99.0
Total		194.0

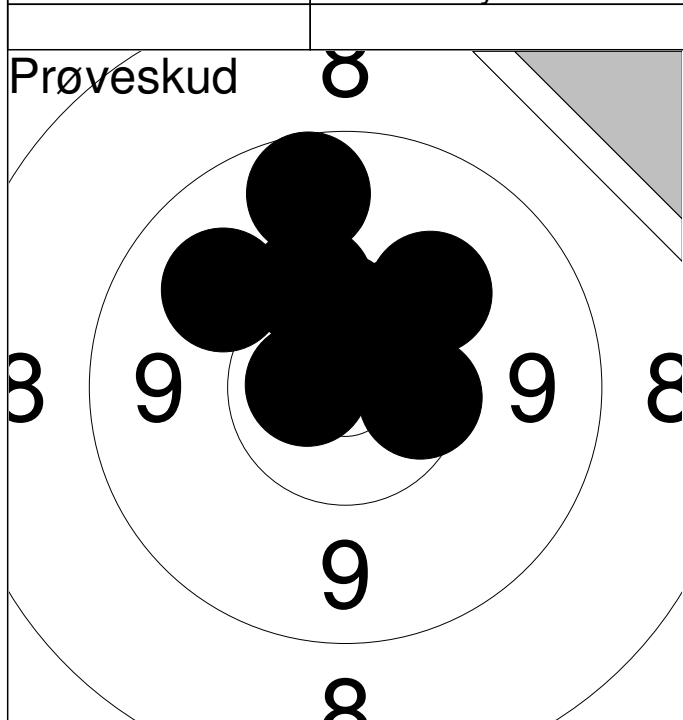

1:	9.6	↑
2:	*10.4	→
3:	*10.5	↑
4:	9.9	↗
5:	*10.7	←
6:	10.2	↑
7:	10.4	↗
8:	10.1	↗
Serie		78.0
Total		0.0

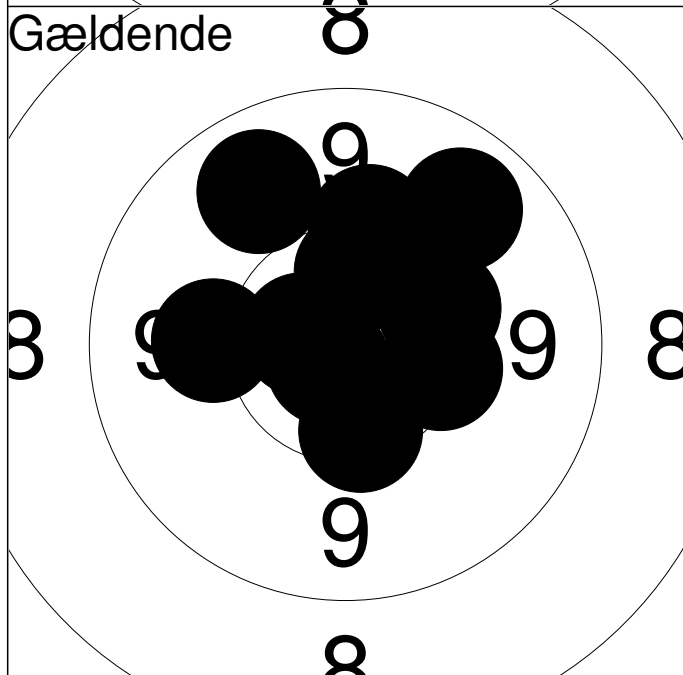

1:	*10.7	←
2:	*10.8	↙
3:	*10.5	↑
4:	10.4	↓
5:	9.8	↗
6:	10.1	↑
7:	10.1	←
8:	10.3	→
9:	10.3	→
10:	9.7	↗
Serie		98.0
Total		98.0

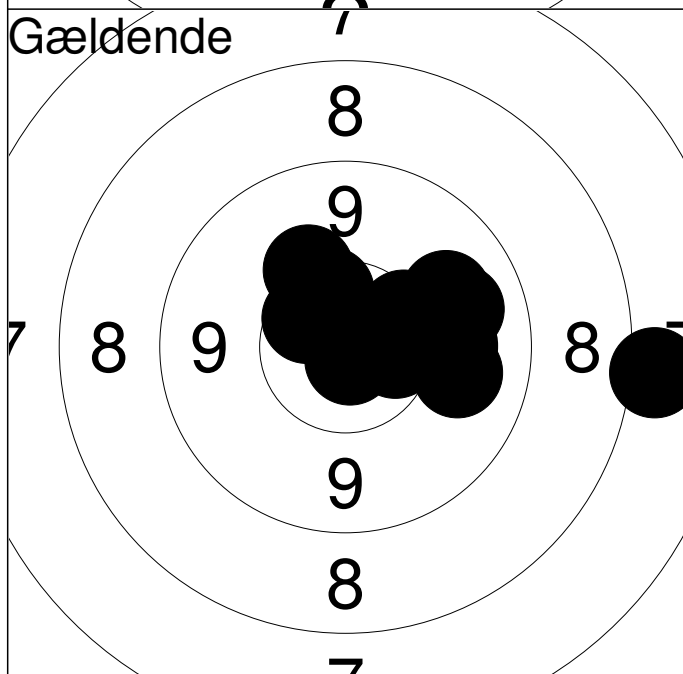

11:	*10.5	↗
12:	7.9	→
13:	*10.4	↗
14:	9.8	→
15:	9.9	↗
16:	*10.8	↙
17:	10.2	↗
18:	9.9	→
19:	*10.5	→
20:	10.3	↗
Serie		94.0
Total		192.0

<p>Prøveskud</p>	<table style="width:100%; border-collapse: collapse;"> <tr><td style="width: 10%;">1:</td><td style="width: 70%;">8.0</td><td style="width: 20%; text-align: center;">↙</td></tr> <tr><td>2:</td><td>9.2</td><td style="text-align: center;">←</td></tr> <tr><td>3:</td><td>9.4</td><td style="text-align: center;">↗</td></tr> <tr><td>4:</td><td>*10.6</td><td style="text-align: center;">↖</td></tr> <tr><td>5:</td><td>*10.7</td><td style="text-align: center;">↘</td></tr> <tr><td>6:</td><td>10.1</td><td style="text-align: center;">↗</td></tr> <tr><td>7:</td><td>9.9</td><td style="text-align: center;">↖</td></tr> <tr><td>8:</td><td>9.8</td><td style="text-align: center;">↑</td></tr> <tr><td>9:</td><td>10.1</td><td style="text-align: center;">↗</td></tr> <tr><td>10:</td><td>*10.5</td><td style="text-align: center;">↘</td></tr> <tr><td colspan="2">Serie</td><td style="text-align: right;">94.0</td></tr> <tr><td colspan="2">Total</td><td style="text-align: right;">0.0</td></tr> </table>	1:	8.0	↙	2:	9.2	←	3:	9.4	↗	4:	*10.6	↖	5:	*10.7	↘	6:	10.1	↗	7:	9.9	↖	8:	9.8	↑	9:	10.1	↗	10:	*10.5	↘	Serie		94.0	Total		0.0
1:	8.0	↙																																			
2:	9.2	←																																			
3:	9.4	↗																																			
4:	*10.6	↖																																			
5:	*10.7	↘																																			
6:	10.1	↗																																			
7:	9.9	↖																																			
8:	9.8	↑																																			
9:	10.1	↗																																			
10:	*10.5	↘																																			
Serie		94.0																																			
Total		0.0																																			

<p>Gældende</p>	<table style="width:100%; border-collapse: collapse;"> <tr><td style="width: 10%;">1:</td><td style="width: 70%;">*10.8</td><td style="width: 20%; text-align: center;">↗</td></tr> <tr><td>2:</td><td>*10.5</td><td style="text-align: center;">↗</td></tr> <tr><td>3:</td><td>*10.5</td><td style="text-align: center;">→</td></tr> <tr><td>4:</td><td>9.6</td><td style="text-align: center;">↘</td></tr> <tr><td>5:</td><td>*10.4</td><td style="text-align: center;">↙</td></tr> <tr><td>6:</td><td>*10.4</td><td style="text-align: center;">↙</td></tr> <tr><td>7:</td><td>*10.5</td><td style="text-align: center;">→</td></tr> <tr><td>8:</td><td>10.1</td><td style="text-align: center;">→</td></tr> <tr><td>9:</td><td>10.1</td><td style="text-align: center;">↘</td></tr> <tr><td>10:</td><td>9.9</td><td style="text-align: center;">↘</td></tr> <tr><td colspan="2">Serie</td><td style="text-align: right;">98.0</td></tr> <tr><td colspan="2">Total</td><td style="text-align: right;">98.0</td></tr> </table>	1:	*10.8	↗	2:	*10.5	↗	3:	*10.5	→	4:	9.6	↘	5:	*10.4	↙	6:	*10.4	↙	7:	*10.5	→	8:	10.1	→	9:	10.1	↘	10:	9.9	↘	Serie		98.0	Total		98.0
1:	*10.8	↗																																			
2:	*10.5	↗																																			
3:	*10.5	→																																			
4:	9.6	↘																																			
5:	*10.4	↙																																			
6:	*10.4	↙																																			
7:	*10.5	→																																			
8:	10.1	→																																			
9:	10.1	↘																																			
10:	9.9	↘																																			
Serie		98.0																																			
Total		98.0																																			

<p>Gældende</p>	<table style="width:100%; border-collapse: collapse;"> <tr><td style="width: 10%;">11:</td><td style="width: 70%;">10.3</td><td style="width: 20%; text-align: center;">↘</td></tr> <tr><td>12:</td><td>10.1</td><td style="text-align: center;">↗</td></tr> <tr><td>13:</td><td>*10.6</td><td style="text-align: center;">←</td></tr> <tr><td>14:</td><td>9.4</td><td style="text-align: center;">↗</td></tr> <tr><td>15:</td><td>*10.7</td><td style="text-align: center;">↖</td></tr> <tr><td>16:</td><td>*10.4</td><td style="text-align: center;">↘</td></tr> <tr><td>17:</td><td>10.1</td><td style="text-align: center;">↘</td></tr> <tr><td>18:</td><td>9.9</td><td style="text-align: center;">↙</td></tr> <tr><td>19:</td><td>*10.7</td><td style="text-align: center;">↖</td></tr> <tr><td>20:</td><td>*10.7</td><td style="text-align: center;">↙</td></tr> <tr><td colspan="2">Serie</td><td style="text-align: right;">98.0</td></tr> <tr><td colspan="2">Total</td><td style="text-align: right;">196.0</td></tr> </table>	11:	10.3	↘	12:	10.1	↗	13:	*10.6	←	14:	9.4	↗	15:	*10.7	↖	16:	*10.4	↘	17:	10.1	↘	18:	9.9	↙	19:	*10.7	↖	20:	*10.7	↙	Serie		98.0	Total		196.0
11:	10.3	↘																																			
12:	10.1	↗																																			
13:	*10.6	←																																			
14:	9.4	↗																																			
15:	*10.7	↖																																			
16:	*10.4	↘																																			
17:	10.1	↘																																			
18:	9.9	↙																																			
19:	*10.7	↖																																			
20:	*10.7	↙																																			
Serie		98.0																																			
Total		196.0																																			

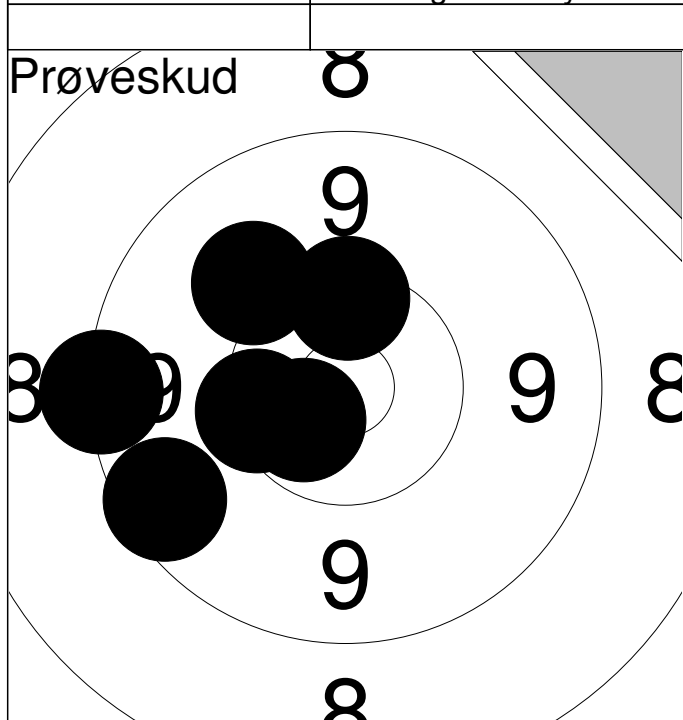

1:	9.3	←
2:	9.5	↙
3:	10.3	←
4:	10.0	↗
5:	*10.6	↙
6:	10.4	↑
Serie		58.0
Total		0.0

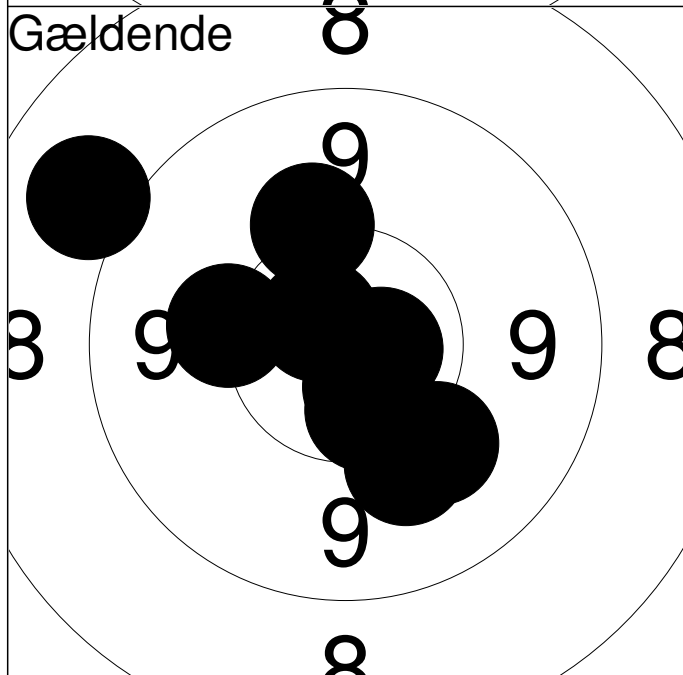

1:	10.1	↑
2:	10.2	←
3:	*10.5	↘
4:	*10.7	↘
5:	*10.6	↘
6:	*10.7	↗
7:	*10.7	↘
8:	10.0	↘
9:	8.9	↗
10:	10.1	↘
Serie		98.0
Total		98.0

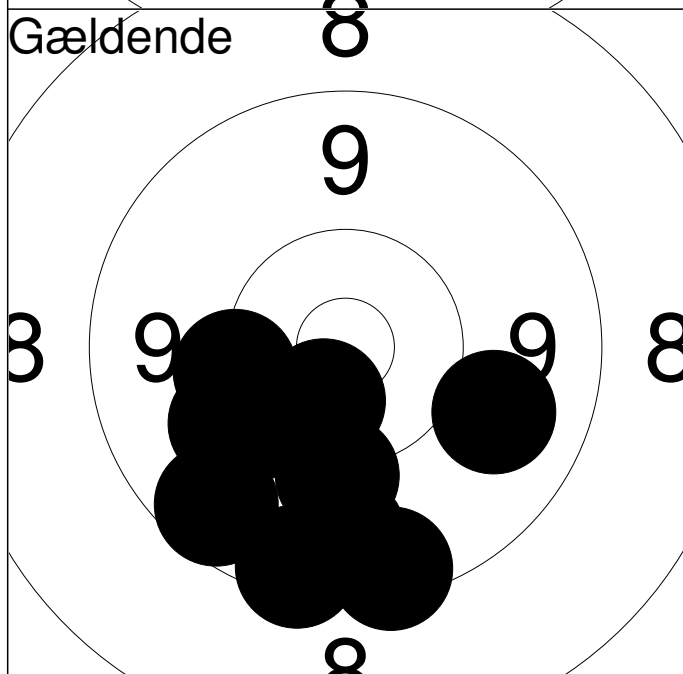

11:	*10.6	↘
12:	9.9	↘
13:	10.3	↙
14:	10.1	↘
15:	9.6	↙
16:	10.2	←
17:	10.0	↙
18:	9.4	↘
19:	9.7	↘
20:	9.4	↘
Serie		95.0
Total		193.0

Vester Hassing Skf.

J2

Prøveskud

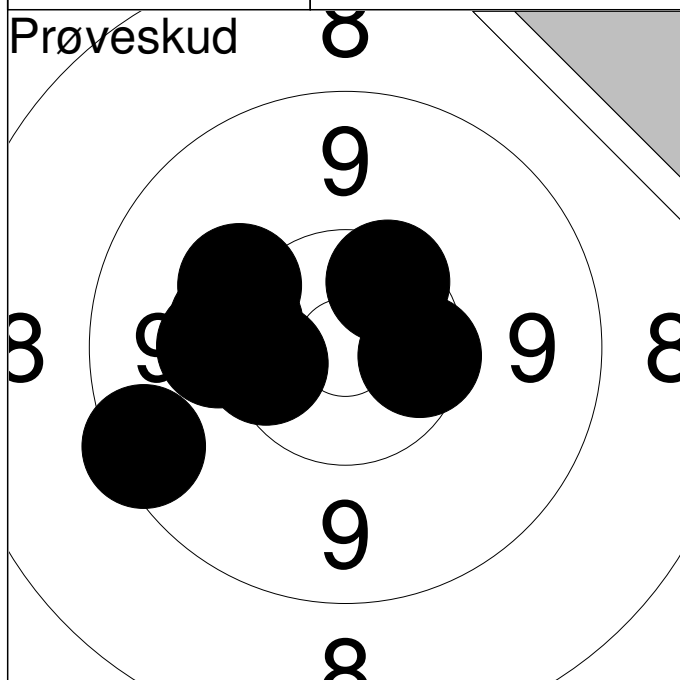

1:	*10.4	→
2:	9.4	←
3:	*10.4	↗
4:	10.4	←
5:	10.2	←
6:	10.2	←
7:	10.1	↗
8:	10.1	←

Serie 79.0

Total 0.0

Gældende

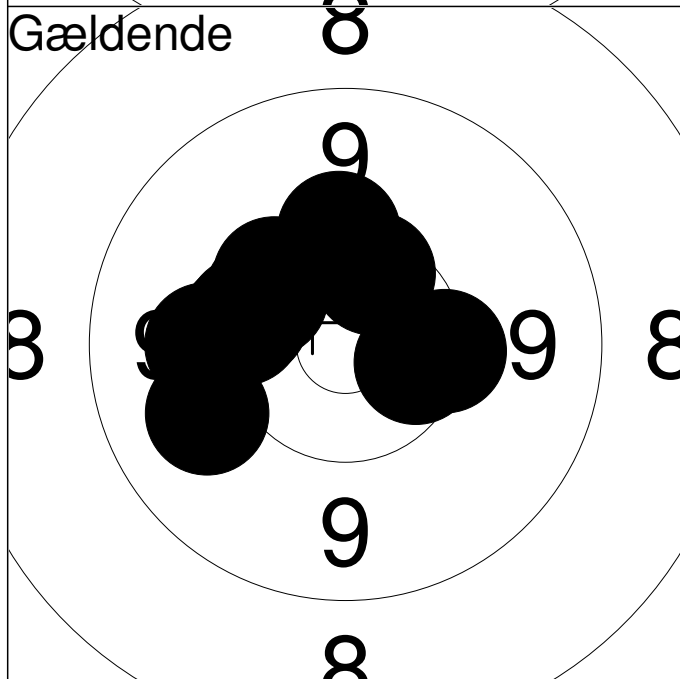

1:	10.3	↗
2:	10.2	↑
3:	*10.4	↗
4:	10.3	→
5:	10.2	←
6:	10.0	←
7:	*10.5	↘
8:	10.3	↗
9:	10.3	←
10:	9.9	←

Serie 99.0

Total 99.0

Gældende

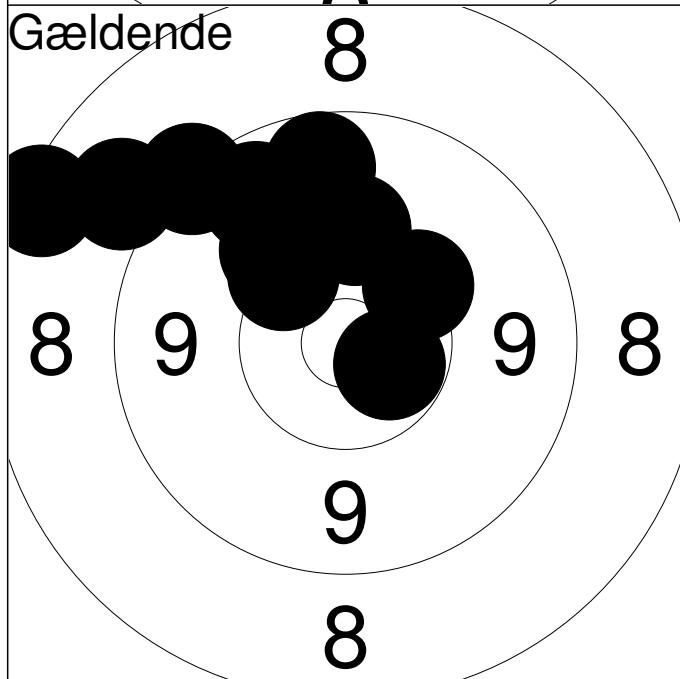

11:	8.9	↗
12:	10.3	↗
13:	10.1	↑
14:	9.7	↗
15:	9.6	←
16:	10.3	↗
17:	*10.6	↘
18:	8.3	↗
19:	10.1	↗
20:	9.2	↗

Serie 93.0

Total 192.0

Vester Hassing Skf.

J2

Prøveskud

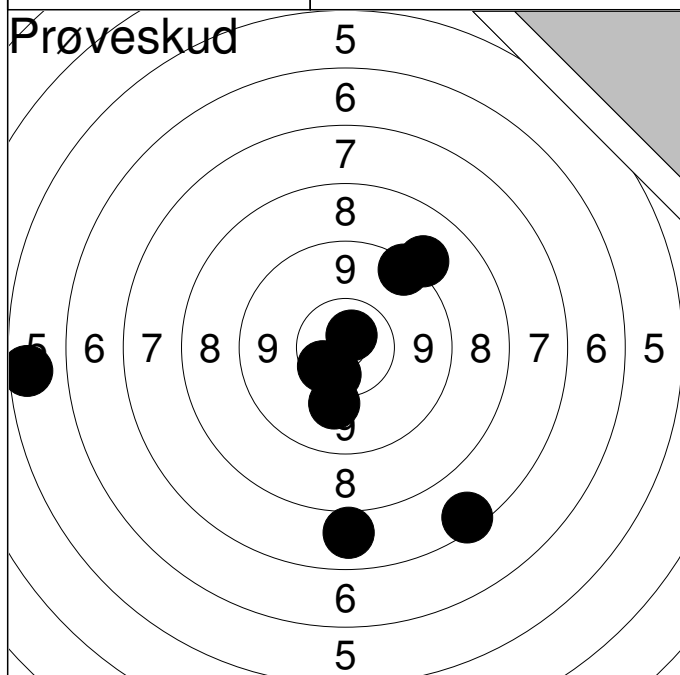

1:	5.5	←
2:	7.4	↘
3:	7.8	↓
4:	*10.5	↘
5:	10.0	↓
6:	9.3	↗
7:	9.0	↗
8:	*10.7	↗
9:	*10.5	↙

Serie	77.0
Total	0.0

Gældende

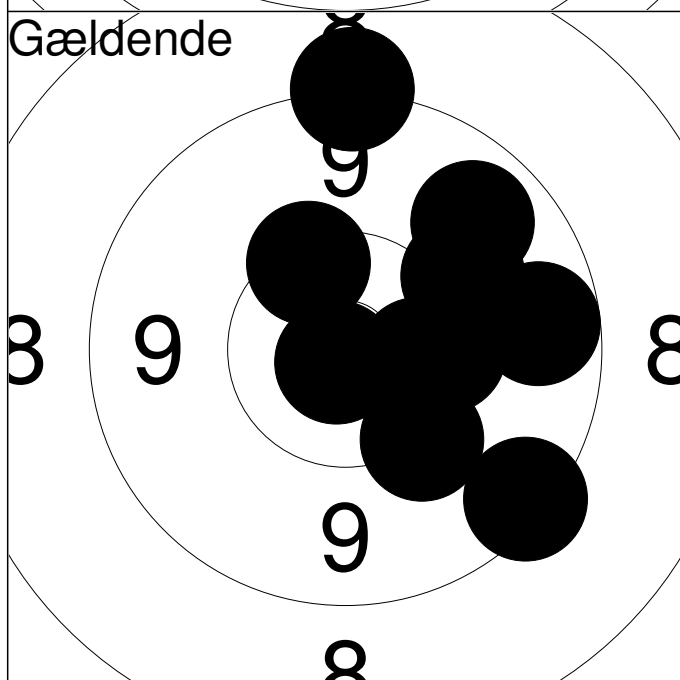

1:	10.3	↗
2:	10.3	→
3:	10.2	↘
4:	*10.8	↘
5:	10.0	↗
6:	9.6	→
7:	9.3	↘
8:	9.1	↑
9:	*10.5	→
10:	9.7	↗

Serie	96.0
Total	96.0

Gældende

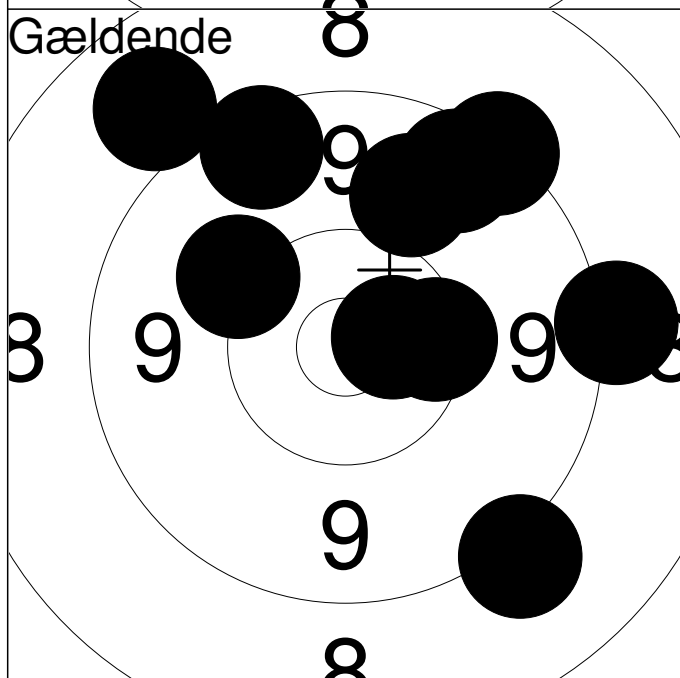

11:	9.8	↗
12:	8.8	↗
13:	9.2	↗
14:	9.5	↗
15:	9.1	↘
16:	10.3	→
17:	10.1	↗
18:	*10.6	→
19:	9.5	↗
20:	9.1	→

Serie	92.0
Total	188.0

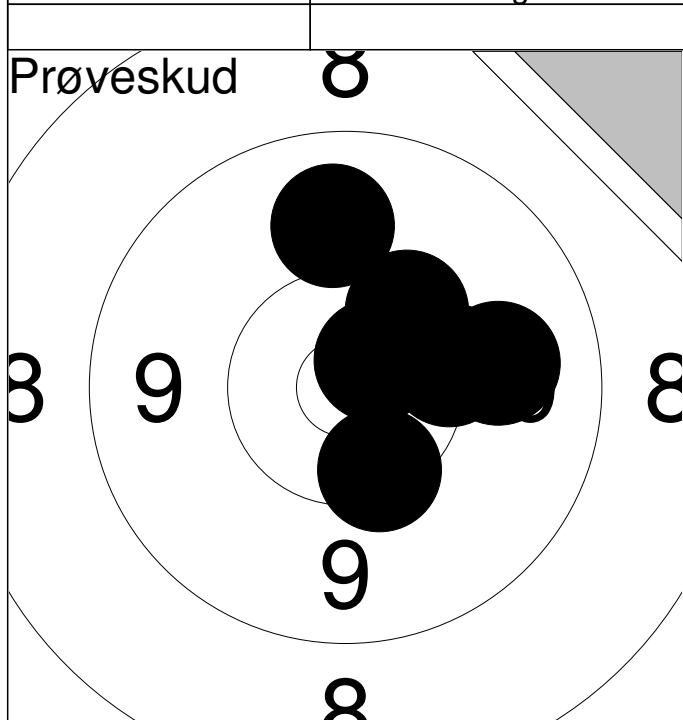

1:	9.9	↑
2:	10.3	↗
3:	*10.7	↗
4:	9.9	→
5:	10.2	→
6:	10.3	↘
Serie		58.0
Total		0.0

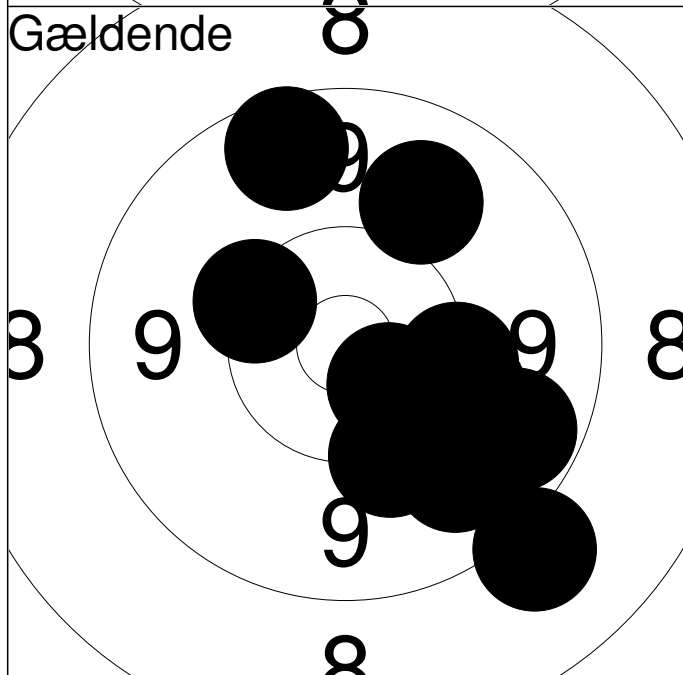

1:	10.1	↘
2:	10.2	→
3:	9.0	↘
4:	10.4	↘
5:	9.5	↗
6:	9.8	↘
7:	9.9	↗
8:	10.3	↗
9:	*10.6	↘
10:	9.7	↘
Serie		95.0
Total		95.0

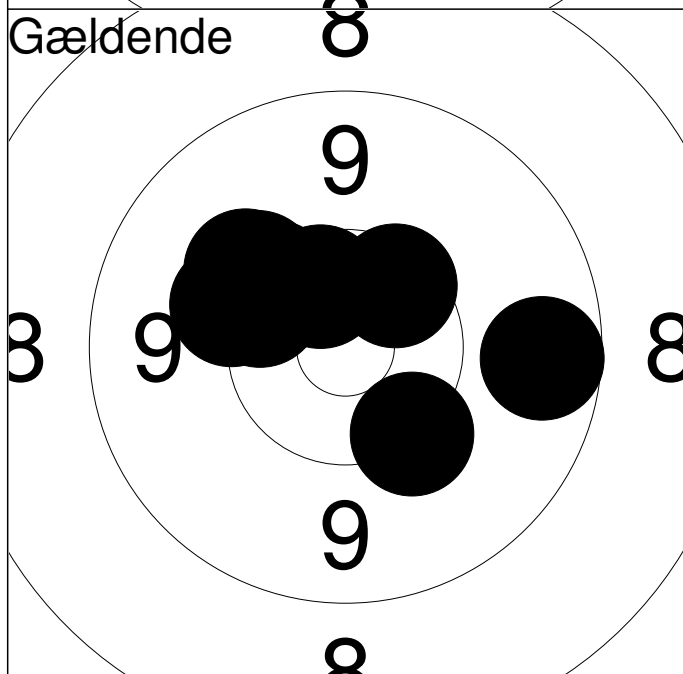

11:	9.6	→
12:	*10.4	↗
13:	10.3	↗
14:	10.1	↗
15:	10.3	↗
16:	10.2	↗
17:	10.2	↘
18:	10.3	↗
19:	*10.5	↗
20:	10.1	↗
Serie		99.0
Total		194.0

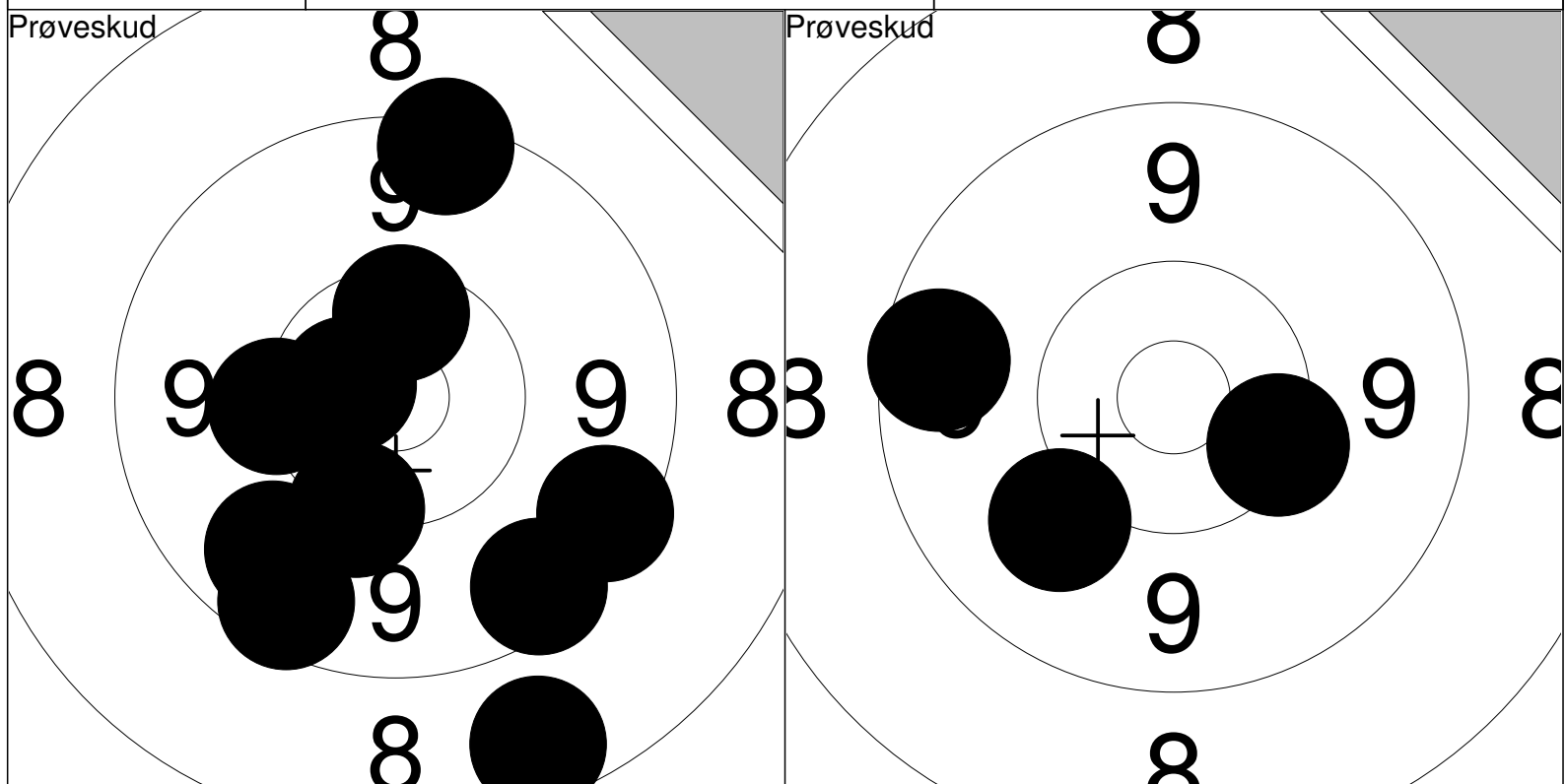

1: 10.2 ↓	6: 9.5 ↓	Serie	93.0	11: 9.5 ←	Serie	29.0
2: 9.5 ↓	7: *10.4 ↑		Total	0.0		12: 10.3 →
3: 10.2 ←	8: 9.3 ↑				13: 10.0 ↙	
4: 9.7 ↘	9: 9.4 ↘					
5: 8.6 ↓	10: *10.6 ←					

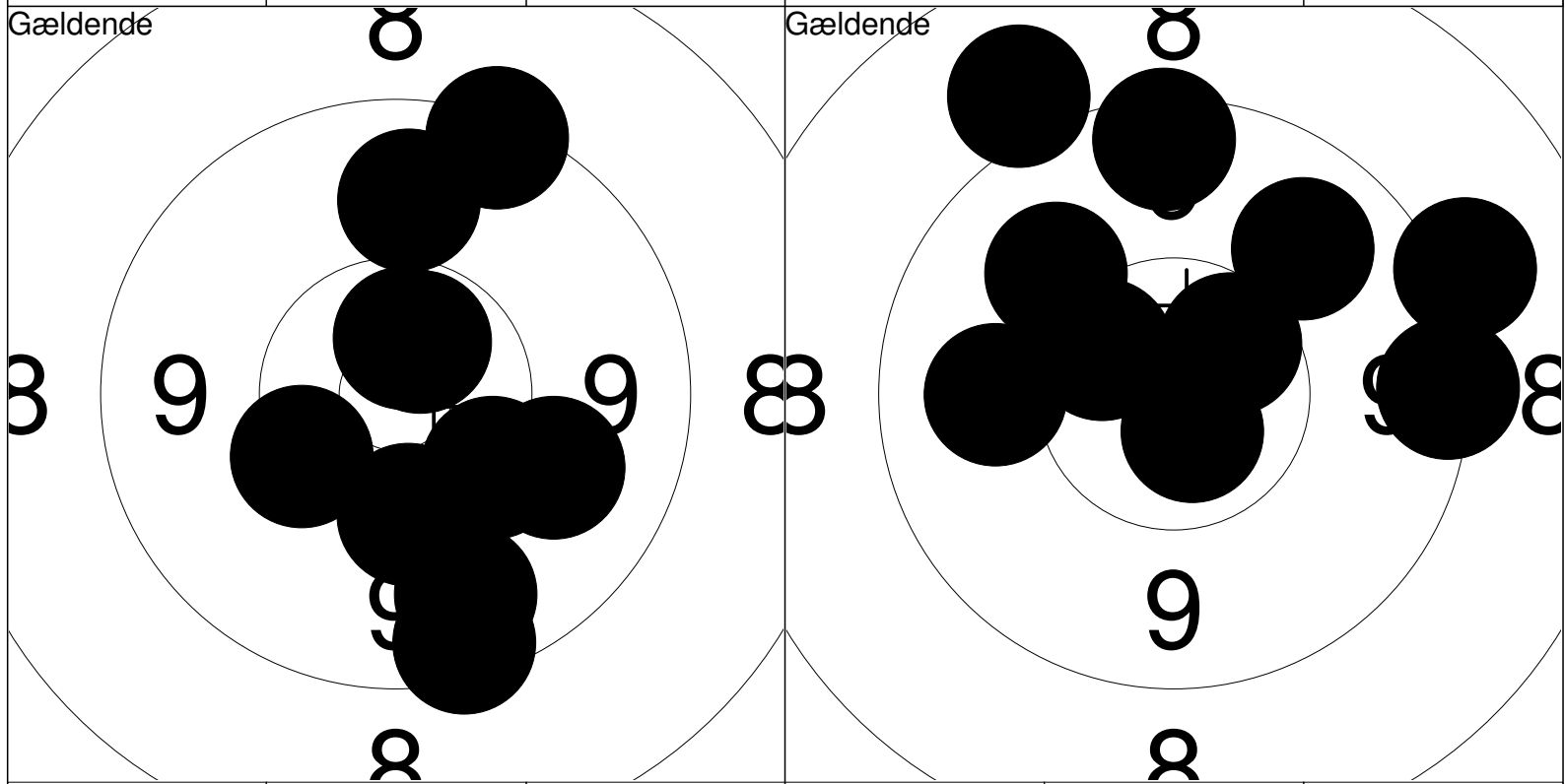

1: 9.4 ↓	6: 10.2 ↘	Serie	95.0	11: 10.0 ↗	16: *10.5 ↗	Serie	93.0
2: 9.9 ↘	7: 10.3 ←		Total	95.0	12: 9.4 ↑		17: *10.7 ↓
3: *10.6 ↗	8: 9.7 ↓				13: *10.5 ↖	18: 9.8 ↗	
4: *10.6 ↑	9: 10.2 ↓			14: 8.9 ↗	19: 9.0 →		
5: 9.3 ↗	10: 9.8 ↑			15: 9.3 →	20: 9.9 ←		

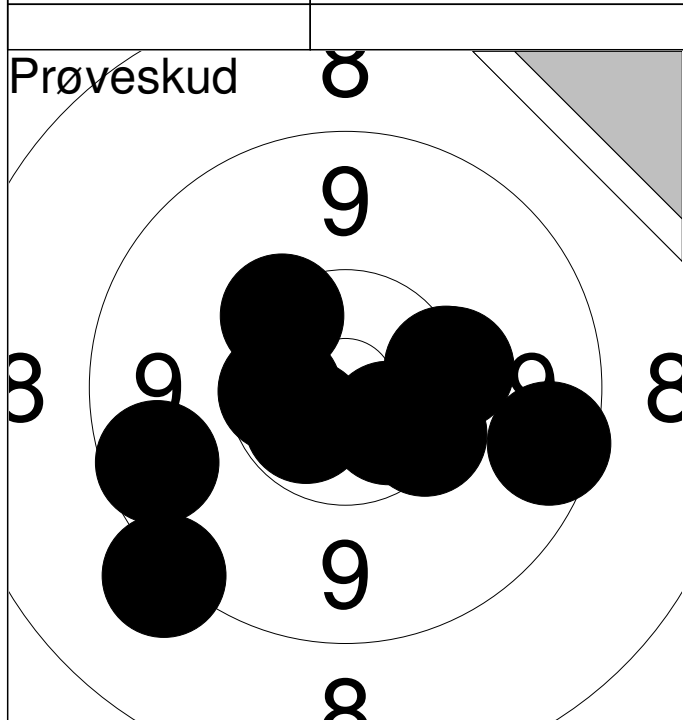

1:	9.1	↙
2:	10.3	→
3:	10.3	↗
4:	9.5	→
5:	9.6	↖
6:	10.2	→
7:	10.3	↘
8:	*10.6	↖
9:	*10.6	↘
10:	*10.5	←
Serie		97.0
Total		0.0

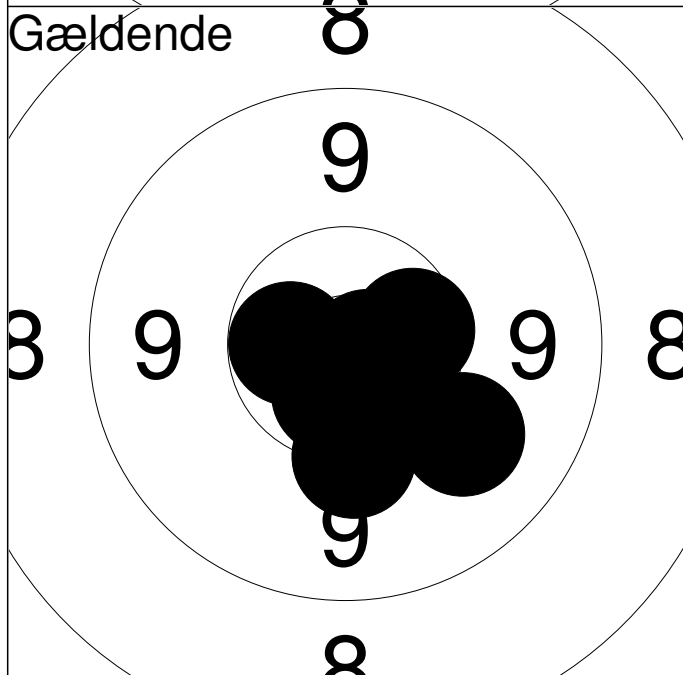

1:	*10.5	↘
2:	*10.5	→
3:	*10.4	↘
4:	10.0	↘
5:	*10.7	→
6:	*10.8	→
7:	*10.6	←
8:	*10.7	↘
9:	10.2	↘
10:	*10.6	↘
Serie		100.0
Total		100.0

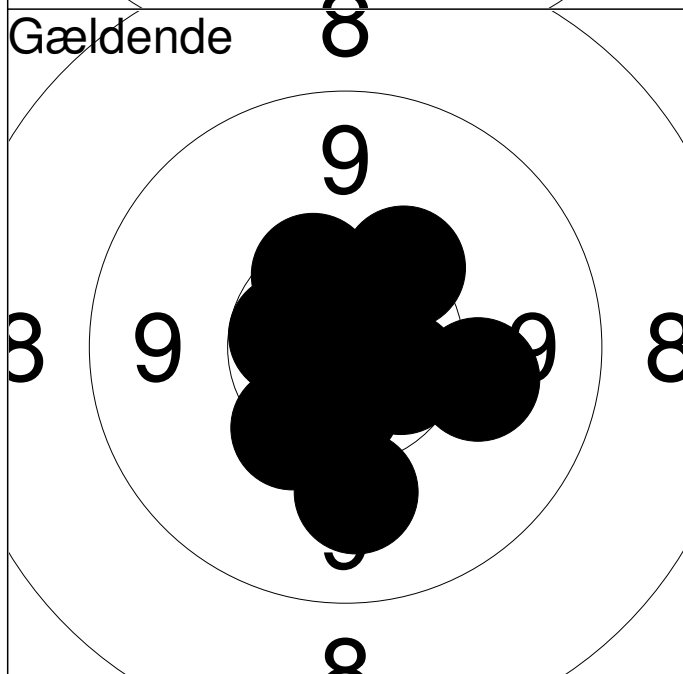

11:	*10.5	→
12:	*10.8	↗
13:	10.0	←
14:	*10.6	←
15:	*10.7	↗
16:	10.3	↗
17:	*10.6	↖
18:	10.3	↖
19:	*10.4	↗
20:	10.0	↘
Serie		100.0
Total		200.0

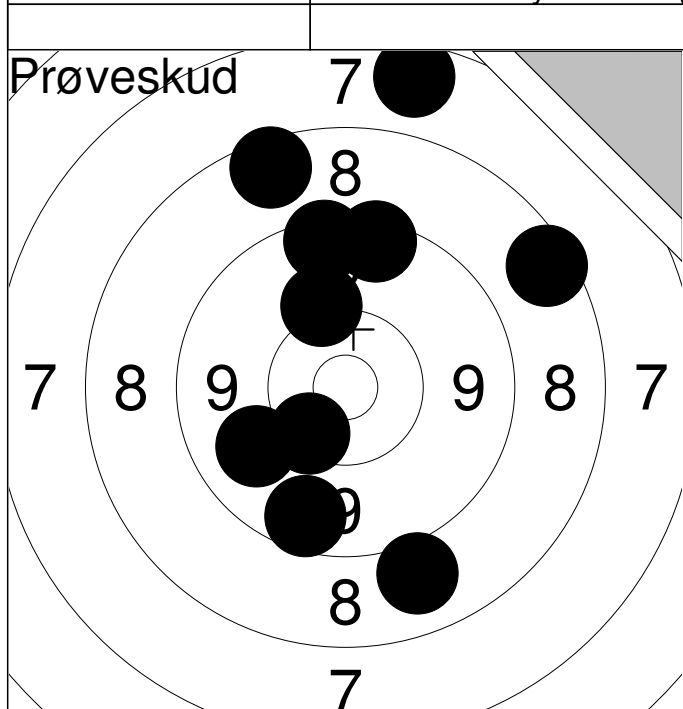

1:	8.4	↗
2:	8.5	↑
3:	9.9	↖
4:	8.8	↓
5:	10.1	↑
6:	7.5	↑
7:	9.4	↑
8:	9.5	↓
9:	9.4	↑
10:	10.4	↙
Serie	87.0	
Total	0.0	

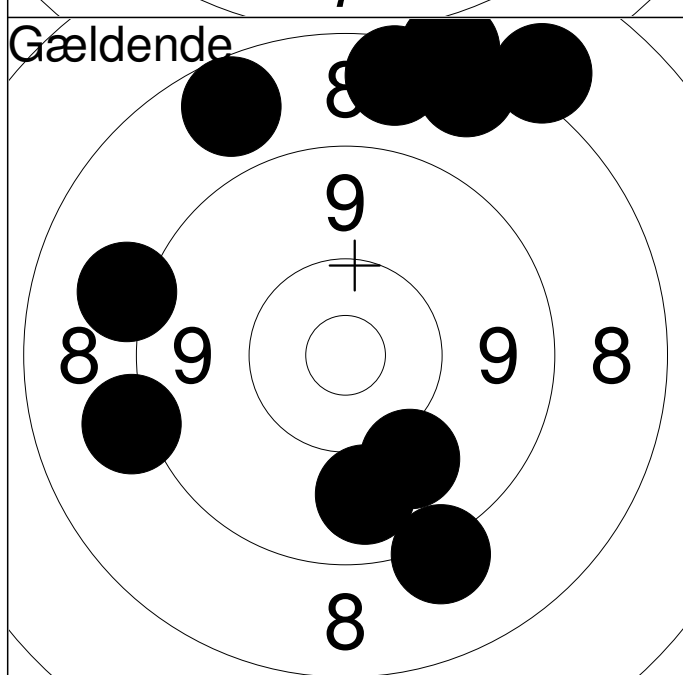

1:	8.0	↗
2:	8.5	↑
3:	8.4	↗
4:	9.8	↓
5:	9.9	↓
6:	9.1	↓
7:	8.6	↗
8:	9.0	↖
9:	9.0	↖
10:	8.2	↑
Serie	85.0	
Total	85.0	

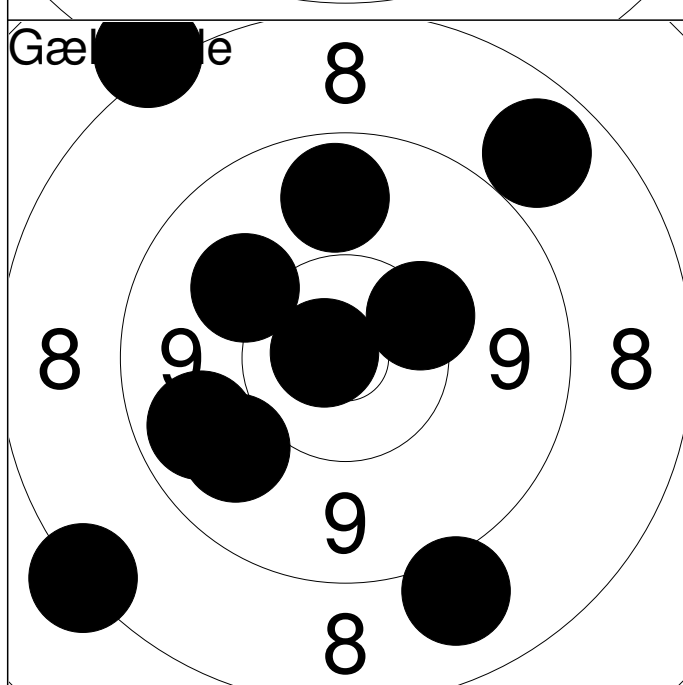

11:	9.7	↑
12:	10.3	↗
13:	9.7	↖
14:	8.9	↓
15:	8.0	↗
16:	10.0	↗
17:	*10.8	↖
18:	8.2	↖
19:	8.7	↗
20:	9.9	↙
Serie	89.0	
Total	174.0	

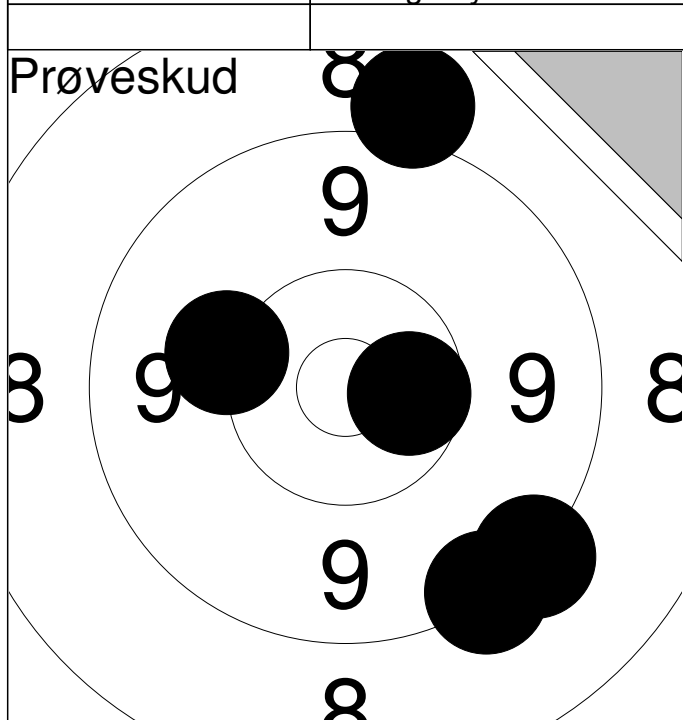

	1:	9.2			↘
	2:	9.2			↘
	3:	8.9			↗
	4:	*10.5			→
	5:	10.1			↗
Serie					46.0
Total					0.0

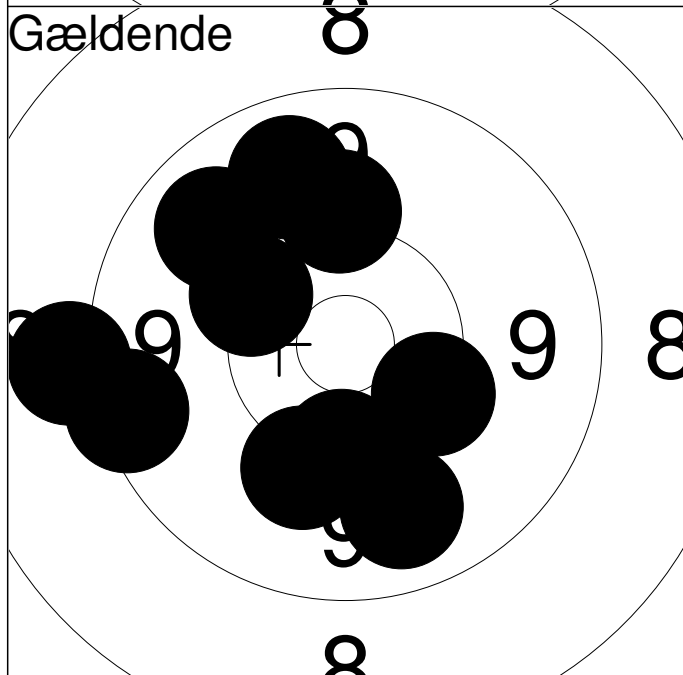

	1:	10.1			↘
	2:	9.4			←
	3:	9.8			↗
	4:	9.8			↘
	5:	9.0			←
	6:	10.2			↘
	7:	10.3			↘
	8:	9.8			↗
	9:	10.1			↗
	10:	10.2			↗
Serie					95.0
Total					95.0

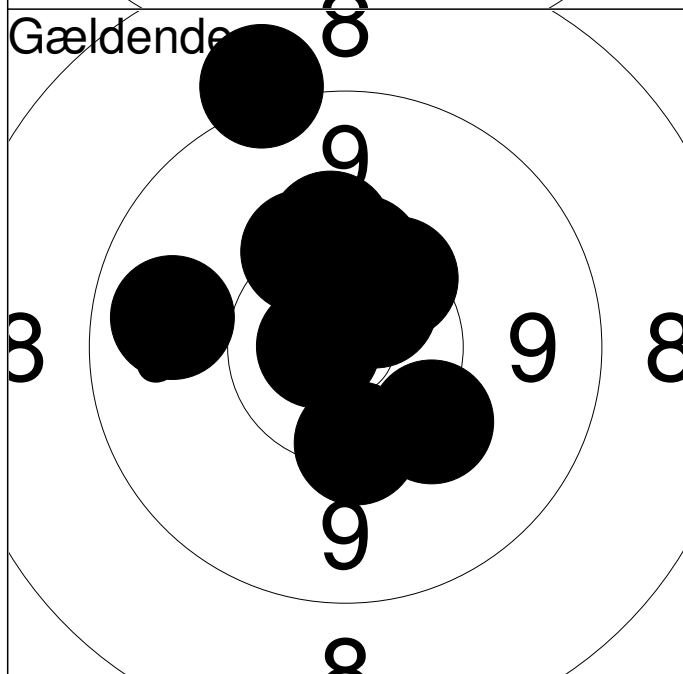

	11:	*10.8			←
	12:	10.2			↘
	13:	9.8			←
	14:	*10.6			↗
	15:	10.4			↗
	16:	10.3			↗
	17:	10.2			↗
	18:	10.2			↗
	19:	9.0			↗
	20:	10.3			↘
Serie					98.0
Total					193.0

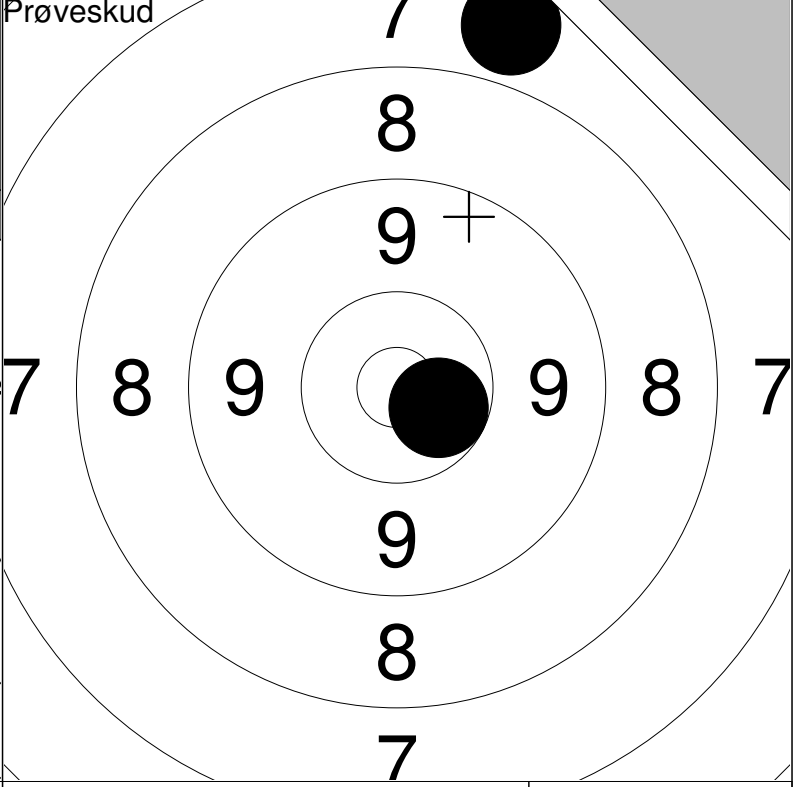
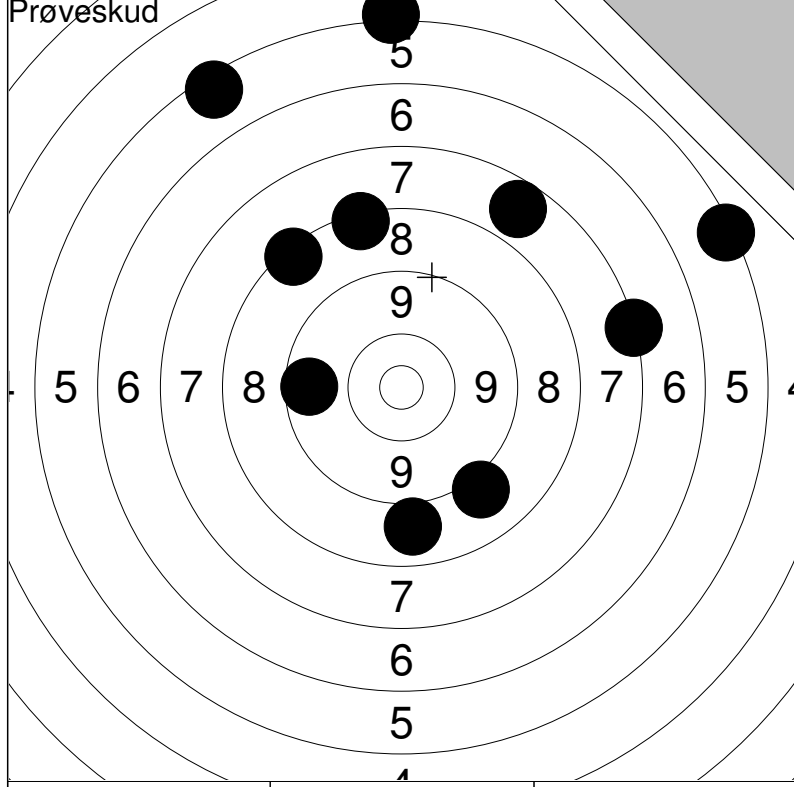

1: 5.1	↑	6: 5.3	↗	Serie	71.0
2: 5.4	↗	7: 8.8	↓		
3: 7.6	↗	8: 8.3	↑	Total	0.0
4: 7.2	→	9: 8.3	↗		
5: 9.0	↓	10: 9.6	←		

11: 7.7	↑	Serie	17.0
12: *10.6	→		
		Total	0.0

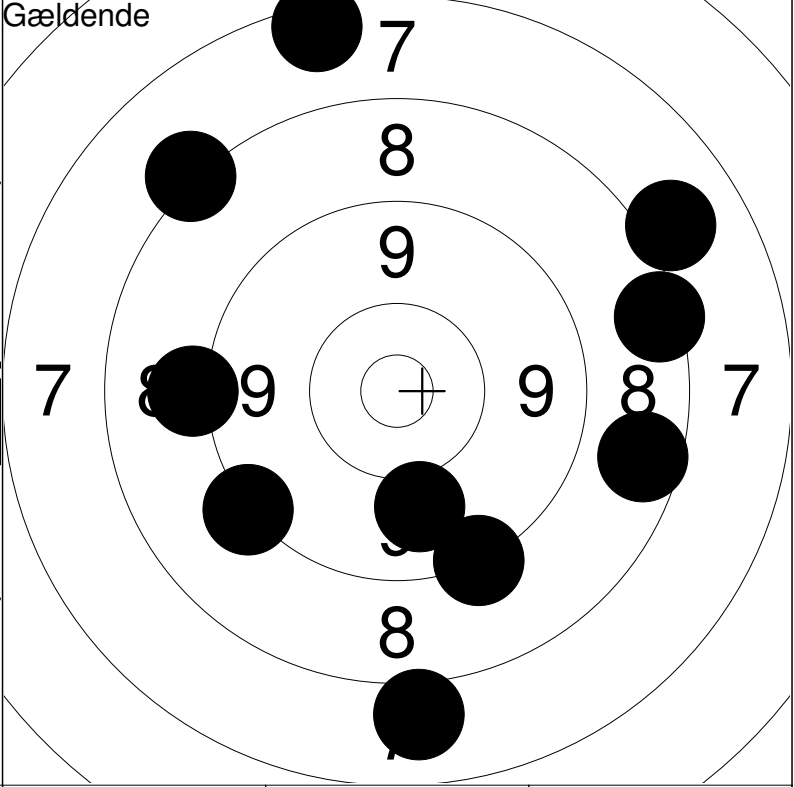
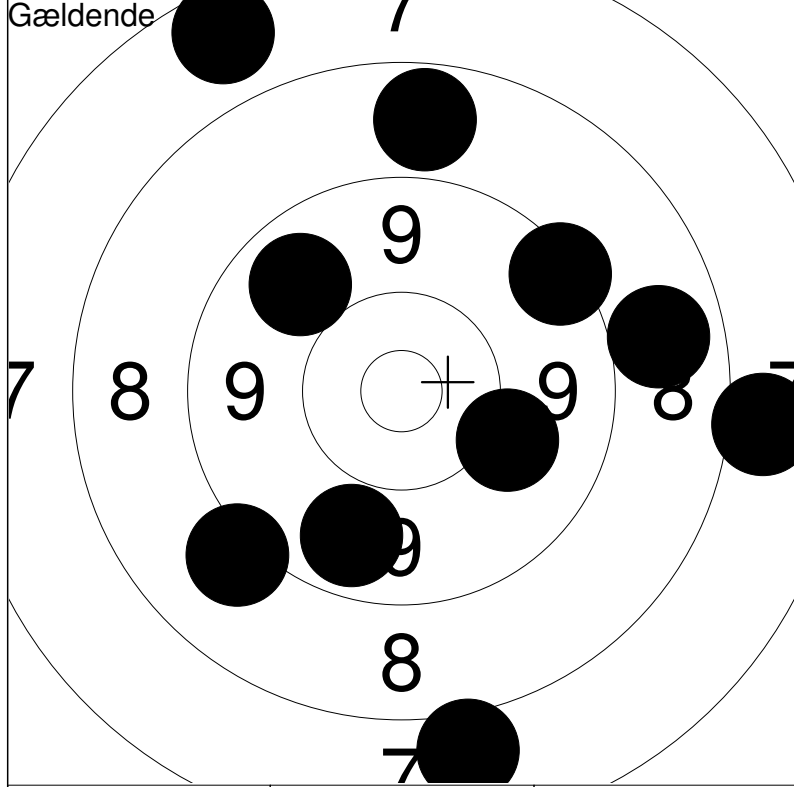

1: 7.9	↓	6: 9.3	↗	Serie	83.0
2: 8.8	→	7: 9.0	↙		
3: 9.8	↗	8: 10.0	→	Total	83.0
4: 9.7	↓	9: 7.9	→		
5: 8.7	↑	10: 7.6	↗		

11: 9.0	←	Serie	81.0
12: 9.2	↙		
13: 7.9	↓	Total	164.0
14: 9.2	↓		
15: 9.9	↓	16: 8.5	→
		17: 8.1	↗
		18: 7.4	↑
		19: 7.9	↗
		20: 8.4	→

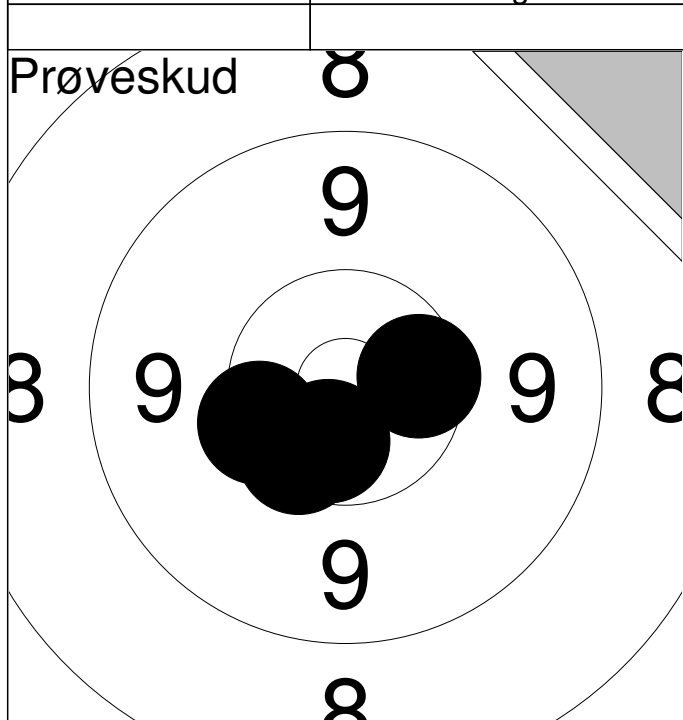

1:	*10.6	↓
2:	10.3	←
3:	*10.5	→
4:	10.4	↙
Serie		40.0
Total		0.0

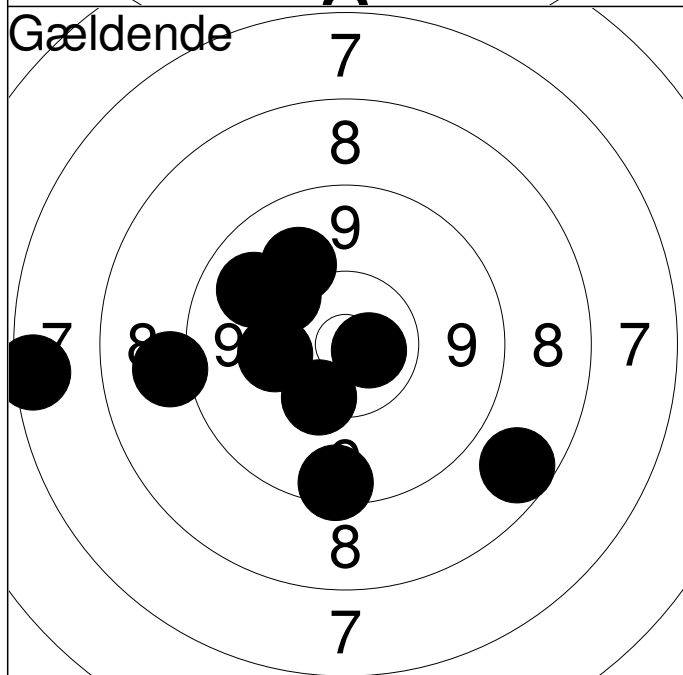

1:	9.8	↗
2:	10.1	↗
3:	9.0	←
4:	10.0	↗
5:	7.4	←
6:	*10.7	→
7:	10.3	↙
8:	9.4	↓
9:	10.2	←
10:	8.6	↘
Serie		92.0
Total		92.0

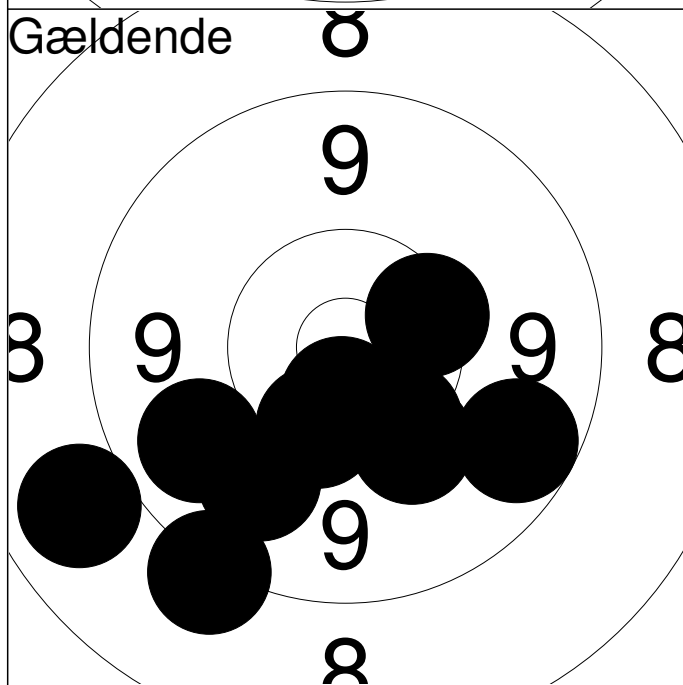

11:	8.8	↙
12:	9.9	↙
13:	9.6	↘
14:	10.2	↙
15:	*10.6	↙
16:	10.4	→
17:	9.8	↙
18:	9.1	↙
19:	10.3	↘
20:	10.4	↘
Serie		94.0
Total		186.0

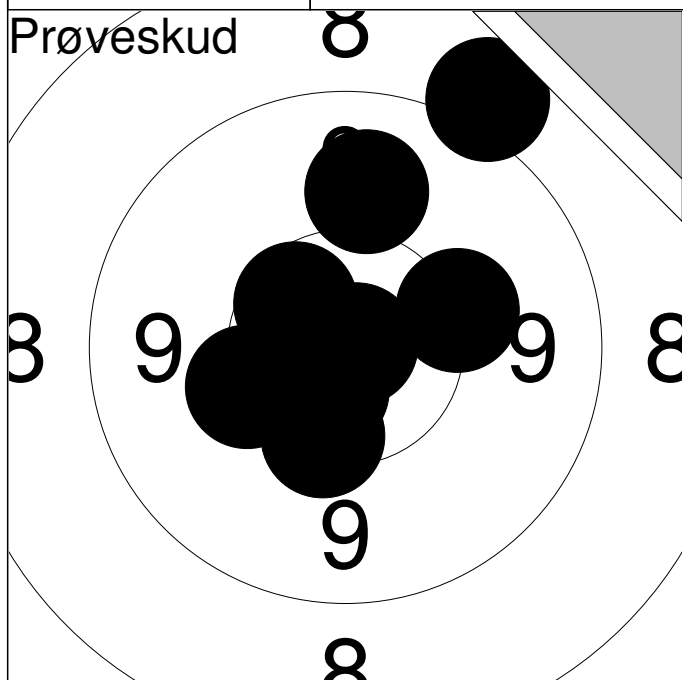

1:	9.0	↗
2:	10.2	→
3:	*10.6	↖
4:	*10.9	→
5:	9.9	↑
6:	10.2	↖
7:	*10.5	↗
8:	10.3	↓
9:	*10.6	↘
Serie		88.0
Total		0.0

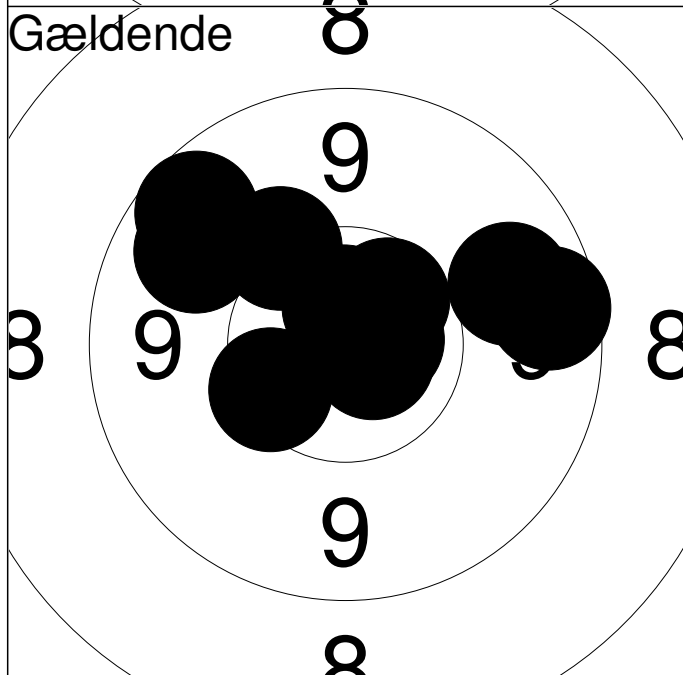

1:	*10.7	→
2:	10.2	↗
3:	*10.5	↗
4:	*10.7	↘
5:	9.8	↗
6:	9.6	↗
7:	9.5	→
8:	10.4	↖
9:	*10.7	↑
10:	9.8	→
Serie		96.0
Total		96.0

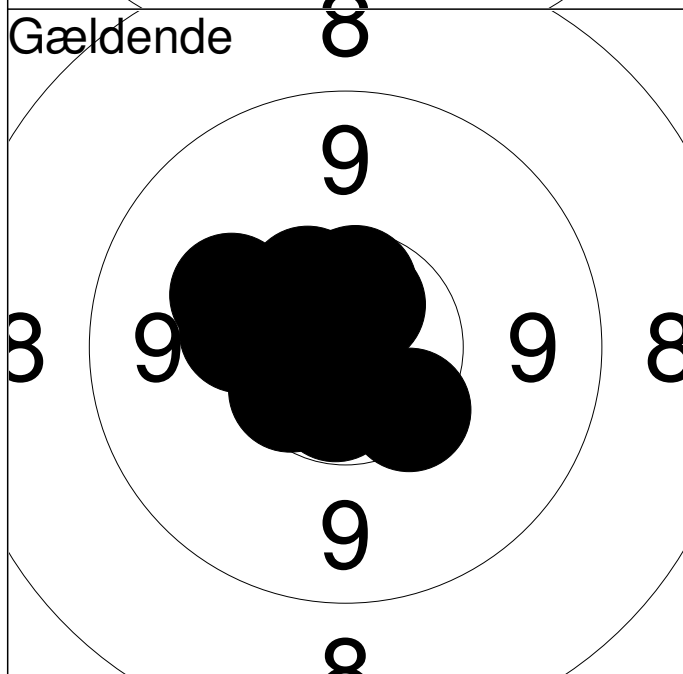

11:	10.4	↘
12:	*10.6	↓
13:	*10.5	↗
14:	*10.6	↗
15:	10.2	↖
16:	*10.6	↖
17:	*10.5	↗
18:	*10.5	↑
19:	10.1	↖
20:	*10.5	↘
Serie		100.0
Total		196.0

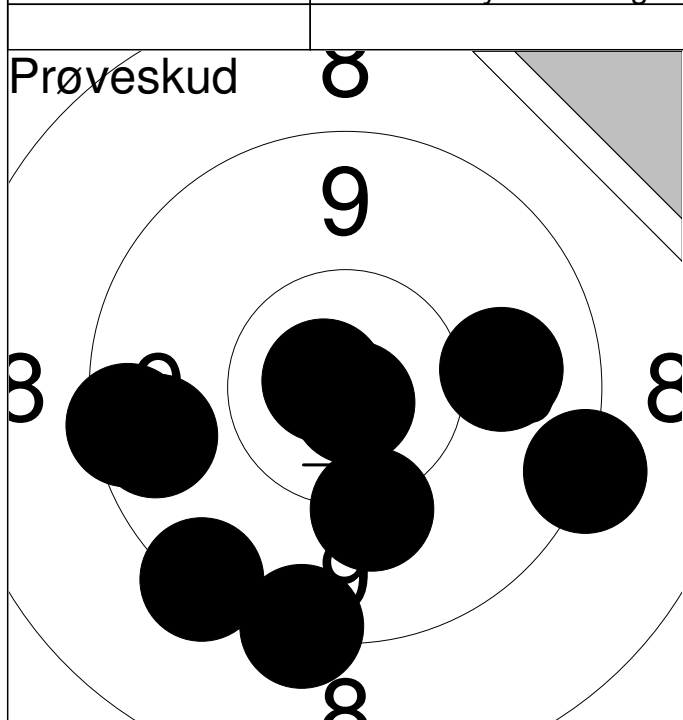

1:	9.4	←
2:	9.3	↙
3:	9.6	←
4:	9.3	↙
5:	*10.8	↙
6:	9.2	↘
7:	*10.8	↑
8:	9.9	→
9:	10.1	↘
Serie		84.0
Total		0.0

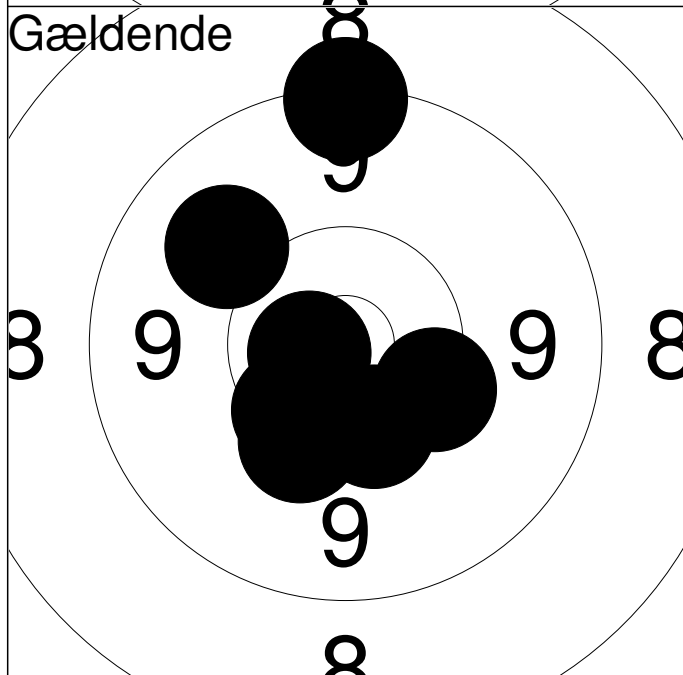

1:	10.4	↙
2:	10.3	↙
3:	10.3	↘
4:	10.4	↙
5:	9.9	↑
6:	10.2	↙
7:	10.4	↘
8:	9.3	↑
9:	*10.7	←
10:	10.4	↙
Serie		98.0
Total		98.0

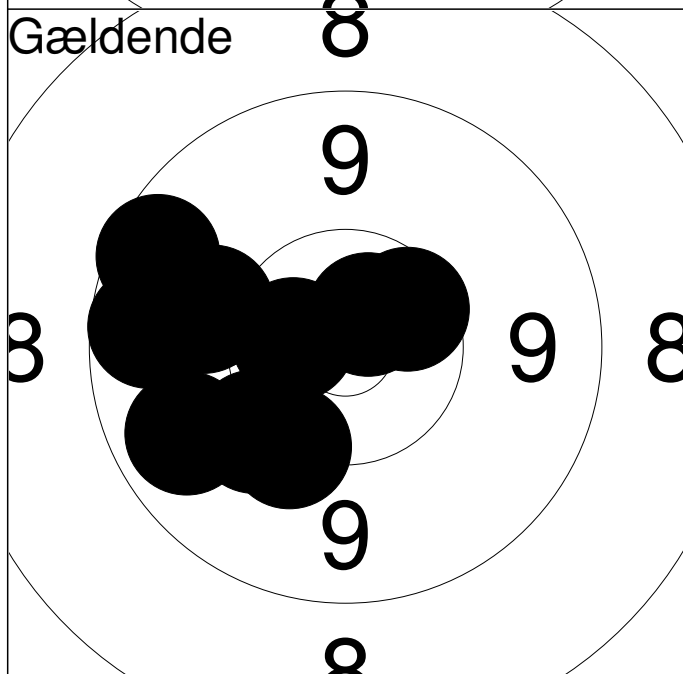

11:	10.0	←
12:	10.0	←
13:	9.6	←
14:	10.1	↙
15:	9.7	↙
16:	10.2	↙
17:	9.5	↑
18:	*10.6	←
19:	*10.5	↗
20:	*10.7	↗
Serie		97.0
Total		195.0

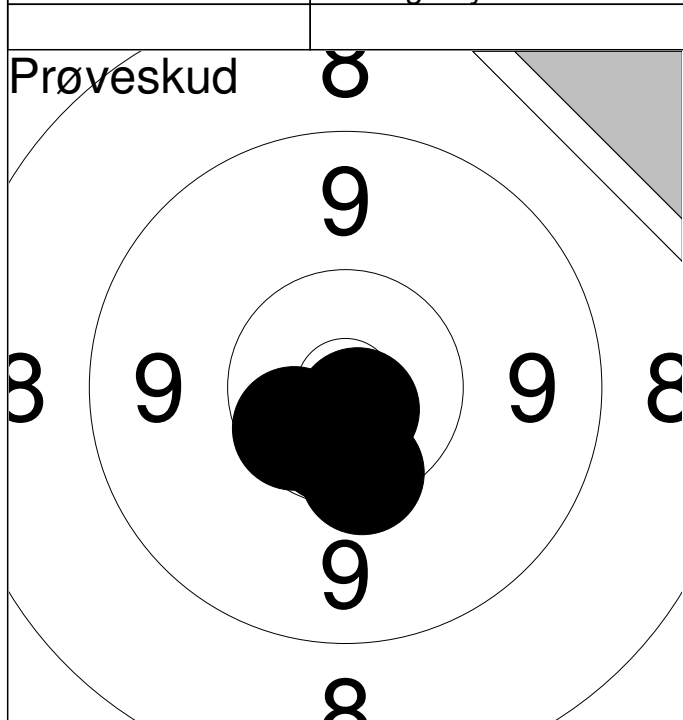

1:	10.4	↓
2:	*10.8	↓
3:	*10.5	↙
4:	*10.6	↓
Serie		40.0
Total		0.0

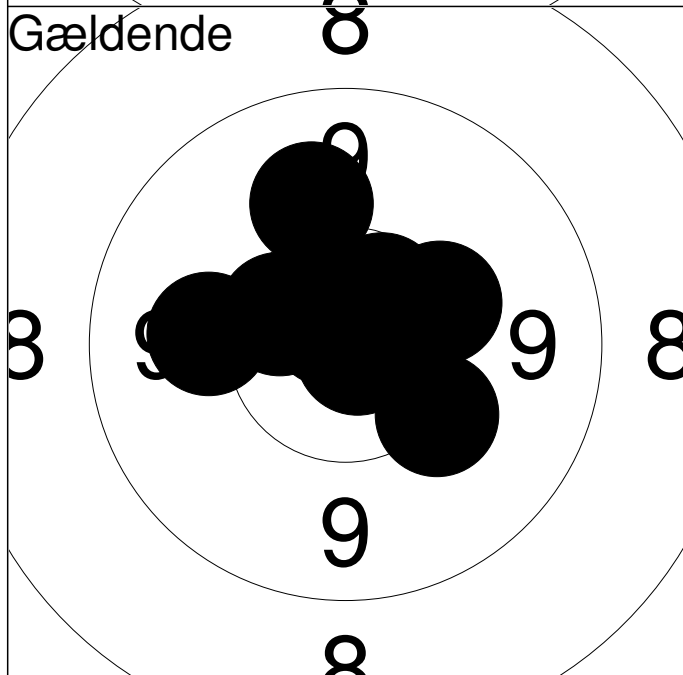

1:	*10.5	↗
2:	*10.8	→
3:	*10.8	↓
4:	10.3	→
5:	10.2	↓
6:	10.0	↗
7:	*10.7	↗
8:	10.0	←
9:	*10.8	↗
10:	*10.5	↗
Serie		100.0
Total		100.0

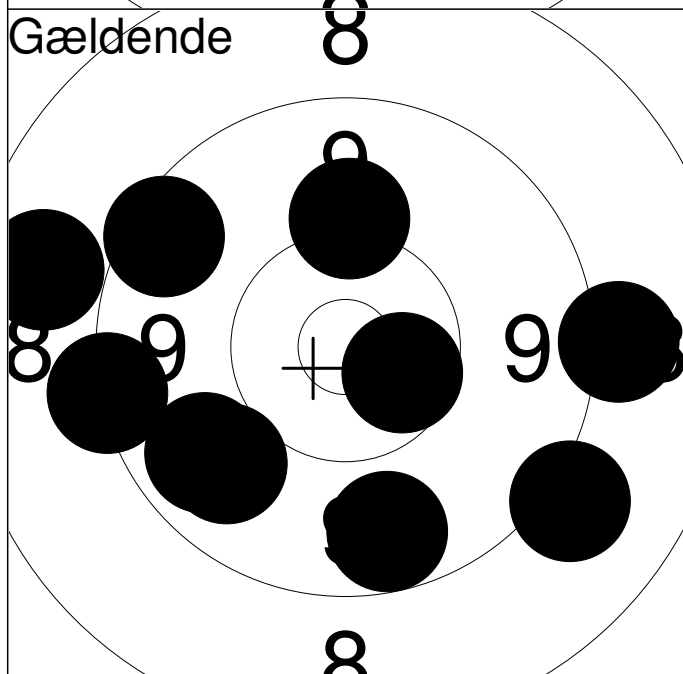

11:	9.6	↓
12:	10.1	↑
13:	9.0	↓
14:	9.7	↙
15:	9.8	↙
16:	9.5	↗
17:	9.0	→
18:	*10.5	↓
19:	9.2	←
20:	8.7	←
Serie		91.0
Total		191.0

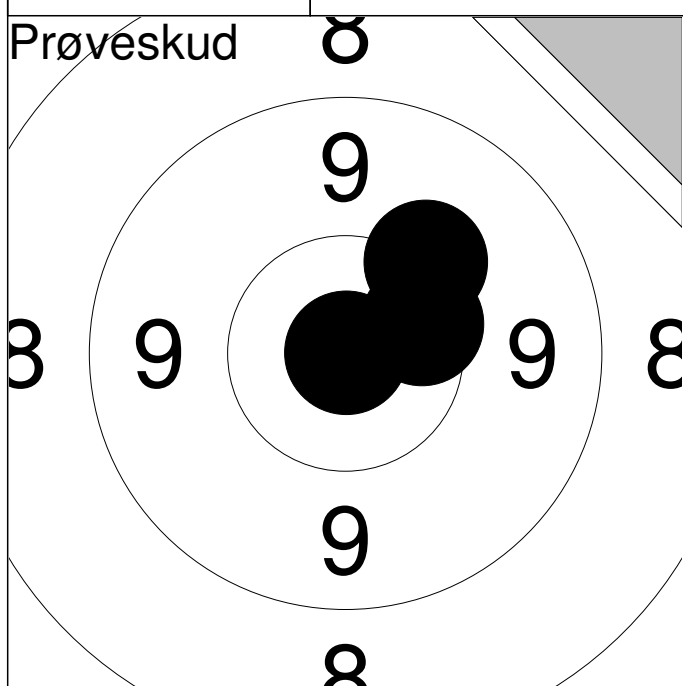

1:	10.4	→
2:	10.1	↗
3:	*10.9	↗
Serie		30.0
Total		0.0

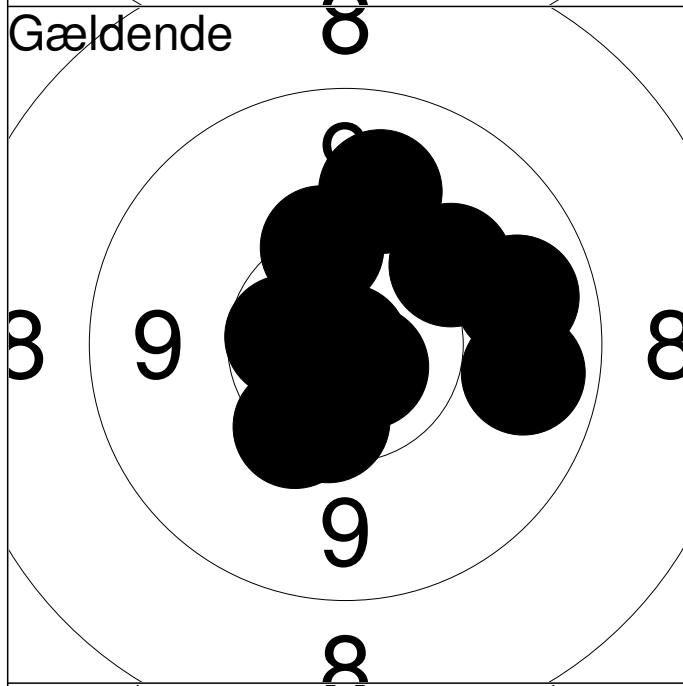

1:	10.1	↗
2:	10.3	↗
3:	*10.4	↓
4:	9.9	↗
5:	*10.5	←
6:	*10.7	↘
7:	9.7	→
8:	*10.9	↘
9:	9.7	→
10:	10.3	↘
Serie		97.0
Total		97.0

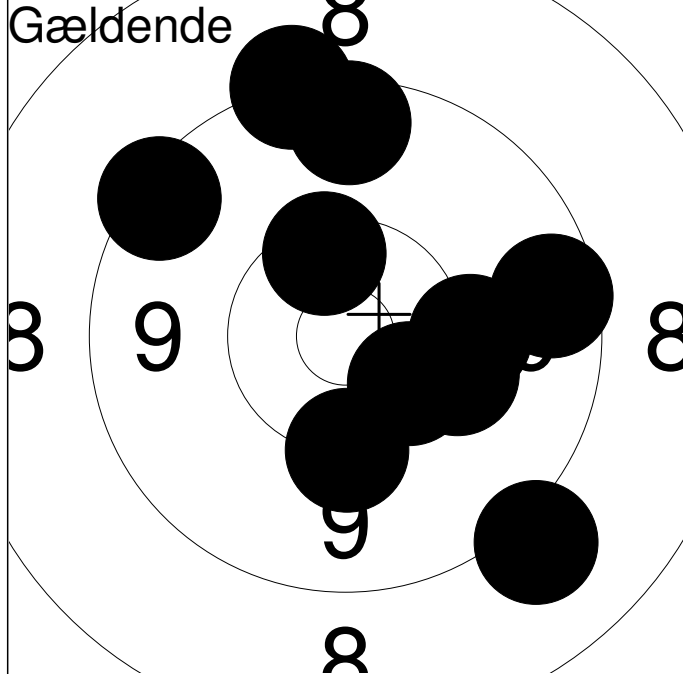

11:	10.2	↓
12:	9.0	↘
13:	9.5	→
14:	9.2	↗
15:	9.4	↗
16:	10.1	→
17:	*10.4	↘
18:	10.4	↗
19:	10.2	→
20:	9.5	↗
Serie		95.0
Total		192.0

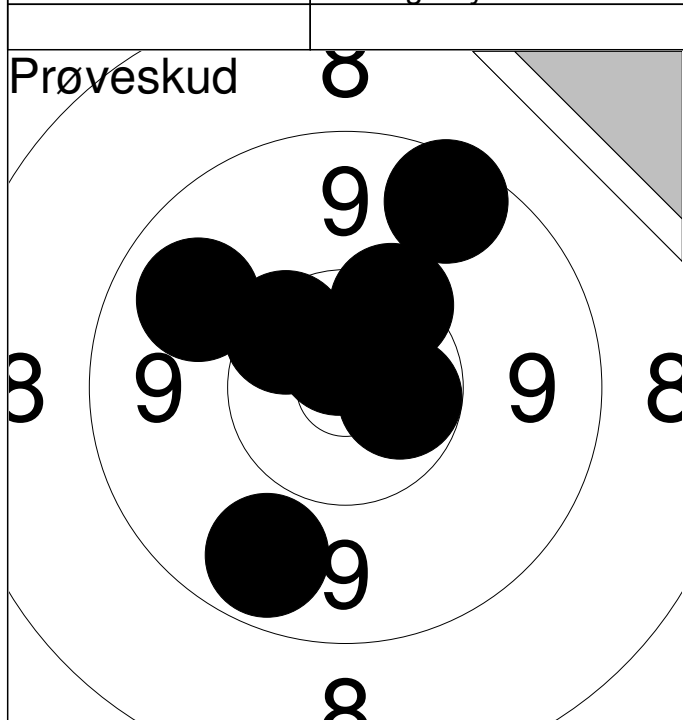

1:	9.5	↗
2:	9.7	↘
3:	*10.7	↗
4:	*10.6	→
5:	10.4	↗
6:	9.8	↗
7:	10.3	↗
Serie		67.0
Total		0.0

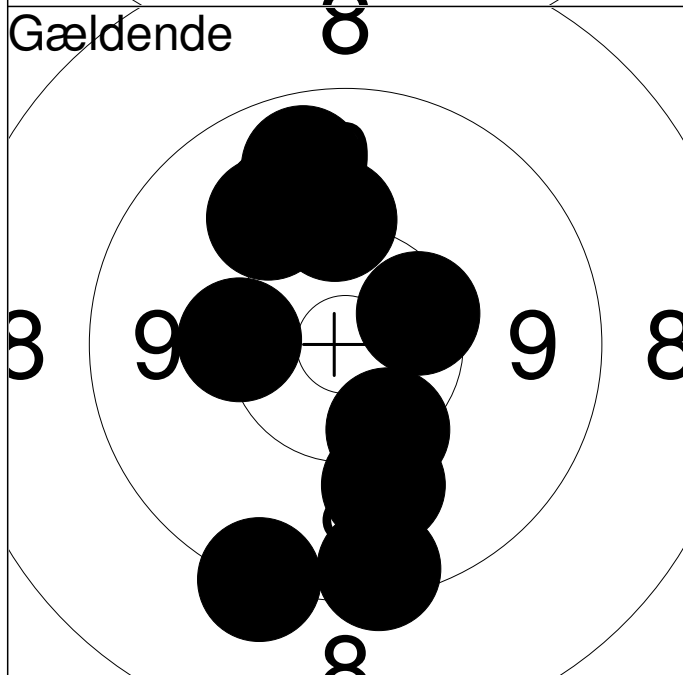

1:	10.0	↗
2:	9.2	↘
3:	9.4	↘
4:	10.2	←
5:	*10.4	→
6:	10.1	↗
7:	9.9	↗
8:	10.0	↘
9:	10.3	↘
10:	9.7	↗
Serie		96.0
Total		96.0

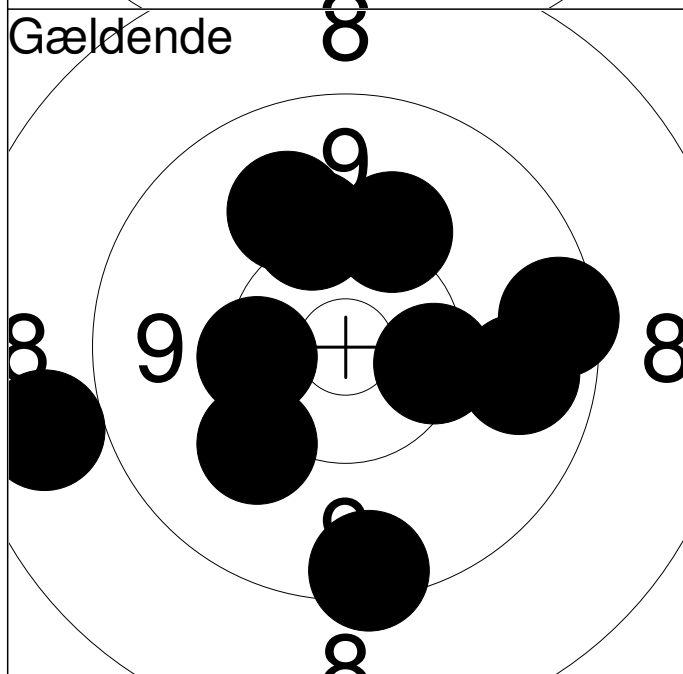

11:	8.7	←
12:	10.3	→
13:	10.1	↗
14:	10.1	↗
15:	9.9	↗
16:	9.4	↘
17:	9.7	→
18:	9.4	→
19:	10.3	←
20:	10.1	↘
Serie		94.0
Total		190.0

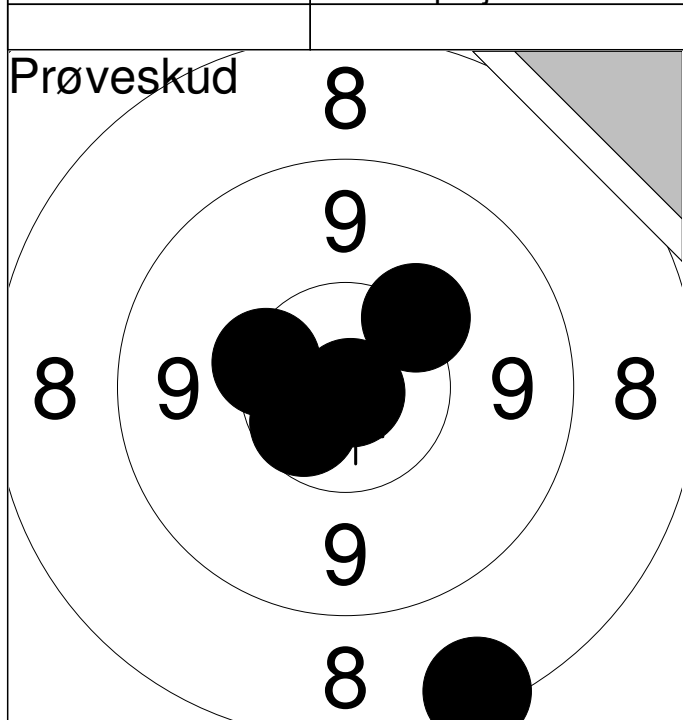

1:	8.3	↓
2:	*10.5	↙
3:	10.3	↖
4:	10.2	↗
5:	*10.9	↓
Serie		48.0
Total		0.0

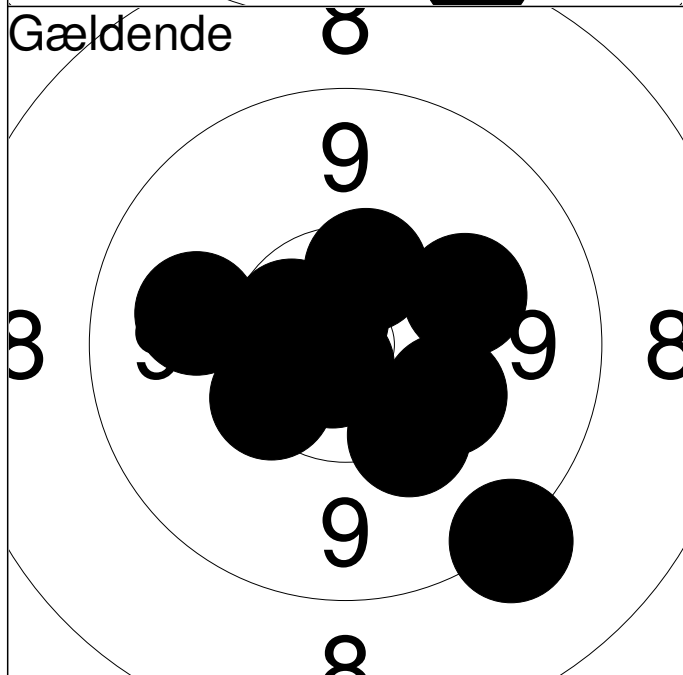

1:	*10.7	↗
2:	10.3	↙
3:	*10.4	↖
4:	10.1	↗
5:	*10.6	↖
6:	10.2	↙
7:	10.2	↙
8:	9.2	↙
9:	9.9	↖
10:	*10.8	↙
Serie		98.0
Total		98.0

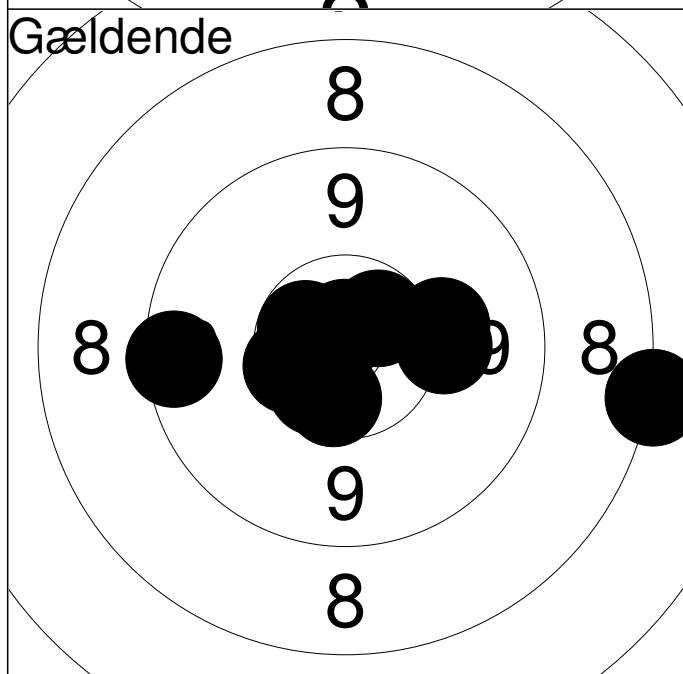

11:	8.1	→
12:	*10.6	↖
13:	9.4	←
14:	*10.8	↑
15:	10.1	→
16:	10.1	→
17:	*10.6	↗
18:	*10.5	↙
19:	*10.5	↙
20:	*10.5	↓
Serie		97.0
Total		195.0

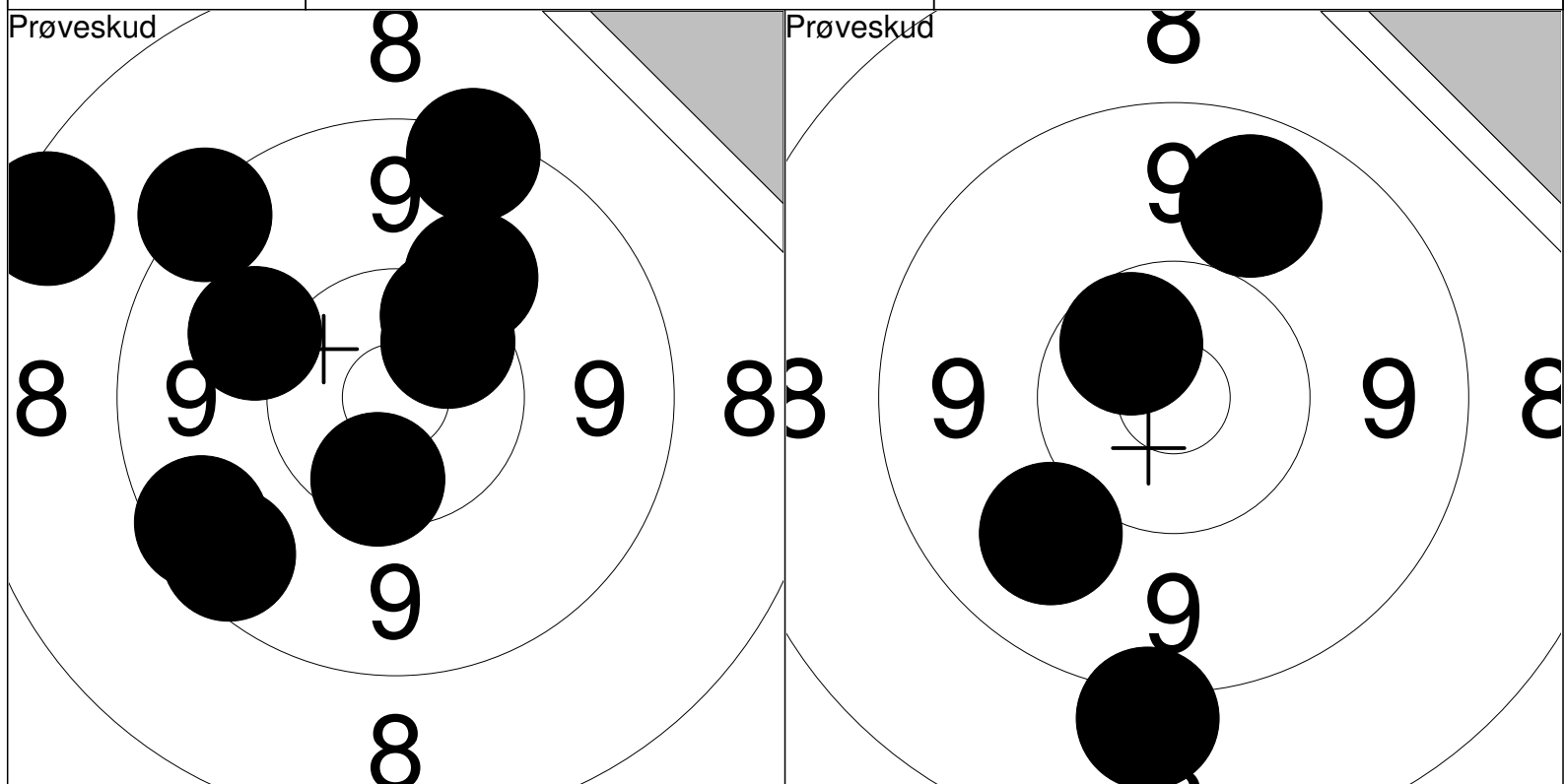

1: 8.4 ↖	6: *10.4 ↓	Serie	94.0	11: *10.6 ↖	Serie	37.0
2: 10.0 ↖	7: *10.5 ↗		Total	0.0		12: 9.9 ↙
3: 9.5 ↙	8: 10.1 ↗				13: 9.0 ↓	
4: 9.3 ↗	9: 10.4 ↗			14: 9.7 ↗		
5: 9.3 ↗	10: 9.5 ↙					

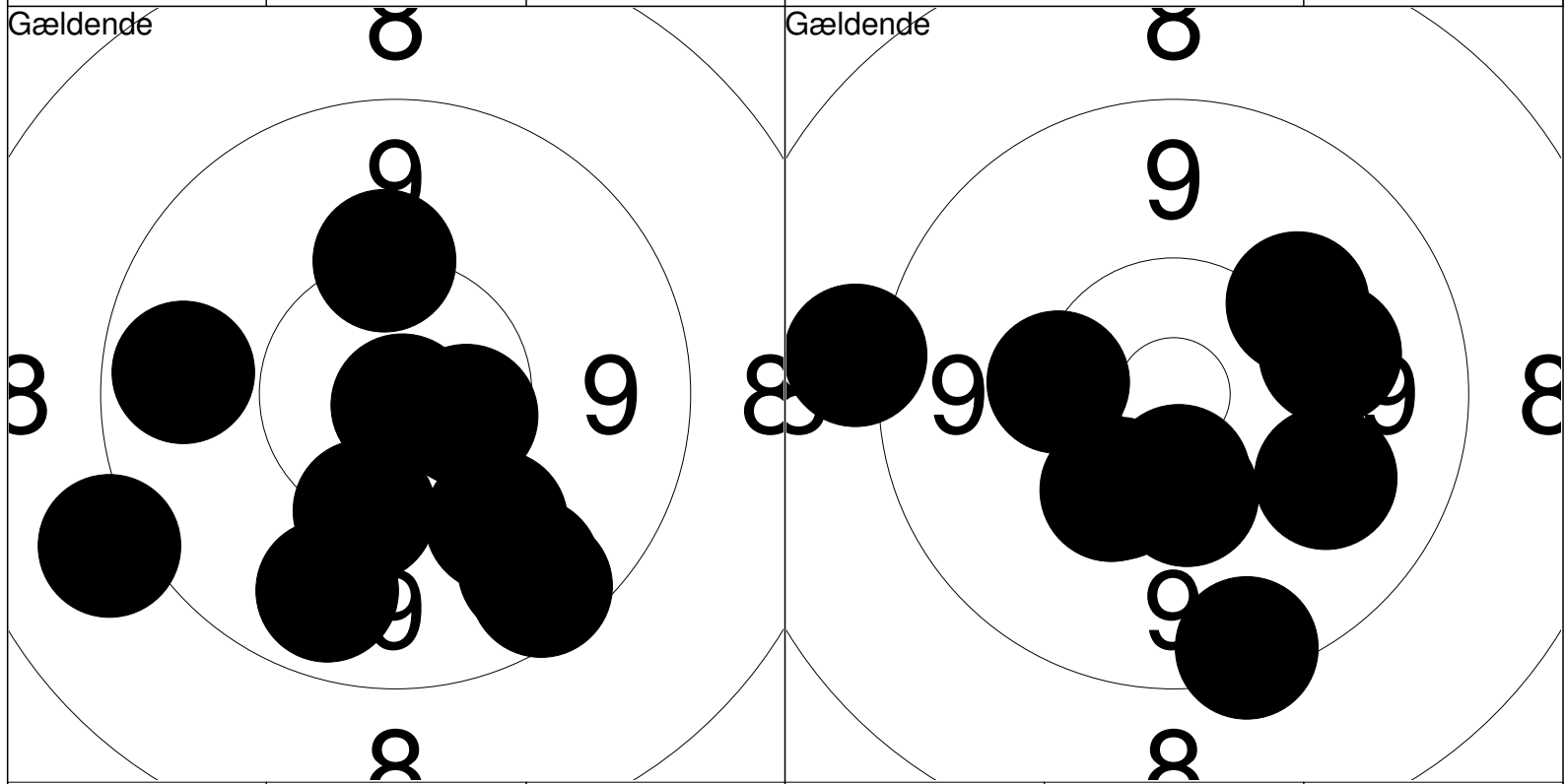

1: 9.6 ↓	6: *10.9 ↓	Serie	95.0	11: 10.3 ↙	Serie	97.0
2: 10.2 ↓	7: 9.7 ←		Total	95.0		12: *10.5 ↓
3: 10.0 ↓	8: *10.5 →				13: 9.9 ↘	
4: 9.5 ↓	9: 9.7 ↓			14: 9.4 ↓		
5: 10.2 ↗	10: 9.0 ↙			15: 10.1 ↗		
				16: 10.4 ↓		
				17: 10.0 →		
				18: 10.3 ←		
				19: 9.0 ←		
				20: 10.3 ↓		

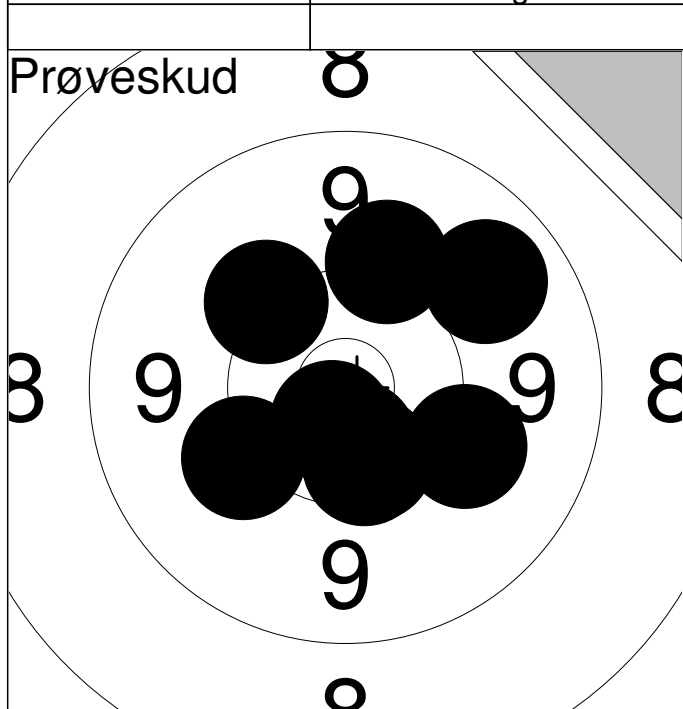

1:	10.1	↘
2:	*10.6	↙
3:	*10.4	↙
4:	*10.4	↙
5:	9.8	↗
6:	10.2	↗
7:	10.1	↗
8:	*10.7	↙
9:	10.1	↙
Serie		89.0
Total		0.0

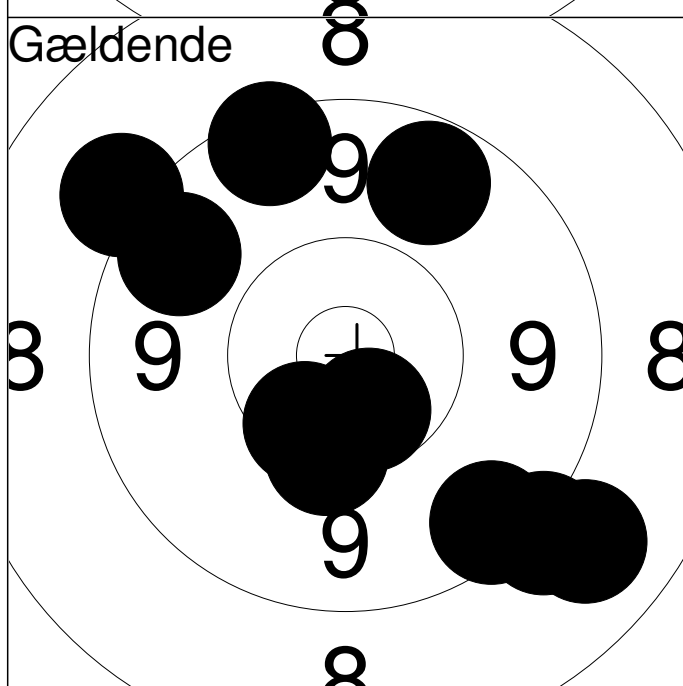

1:	9.4	↘
2:	*10.4	↙
3:	10.3	↙
4:	9.6	↗
5:	9.6	↗
6:	9.4	↗
7:	9.0	↗
8:	*10.6	↙
9:	9.1	↙
10:	8.8	↙
Serie		92.0
Total		92.0

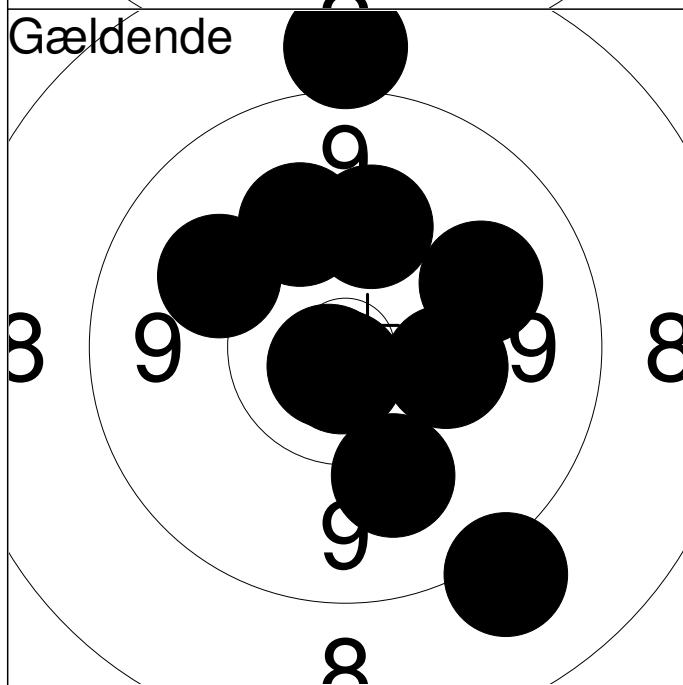

11:	9.0	↘
12:	10.0	↗
13:	8.9	↗
14:	10.0	↙
15:	10.3	→
16:	*10.8	↙
17:	*10.8	↙
18:	10.1	↗
19:	9.9	↗
20:	10.1	↗
Serie		96.0
Total		188.0

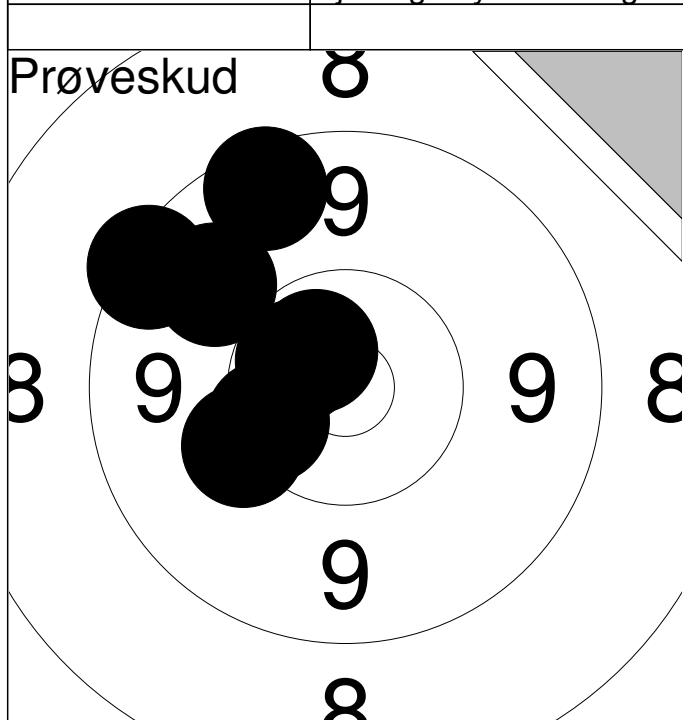

1:	9.5	↗
2:	9.4	↗
3:	9.8	↗
4:	*10.6	↗
5:	10.4	↖
6:	10.2	↖
7:	*10.6	↗
Serie		67.0
Total		0.0

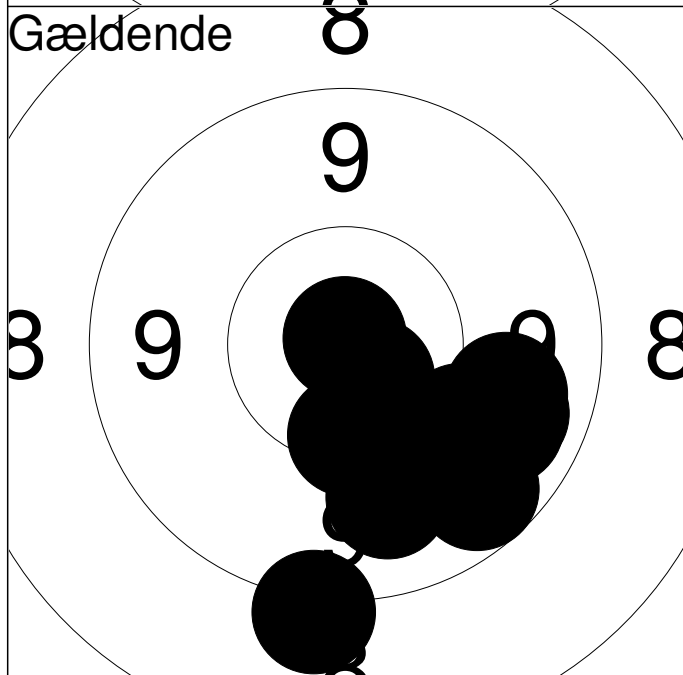

1:	*10.9	↗
2:	9.9	↘
3:	9.8	↘
4:	10.3	↘
5:	9.8	↘
6:	9.1	↖
7:	9.6	↘
8:	*10.7	↘
9:	10.0	↘
10:	9.8	↘
Serie		94.0
Total		94.0

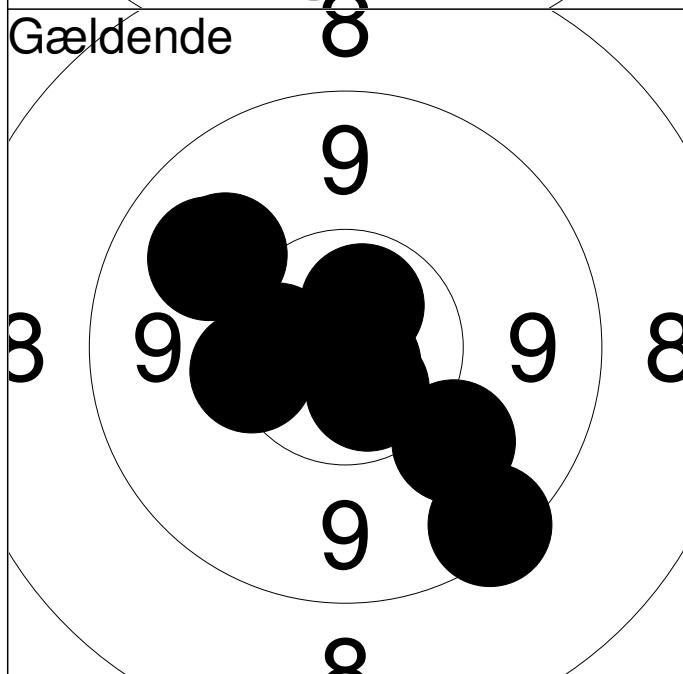

11:	9.4	↘
12:	*10.8	↗
13:	9.9	↗
14:	*10.6	↘
15:	*10.8	↘
16:	*10.5	↖
17:	*10.7	↗
18:	10.3	↖
19:	10.0	↘
20:	9.9	↗
Serie		97.0
Total		191.0

Prøveskud

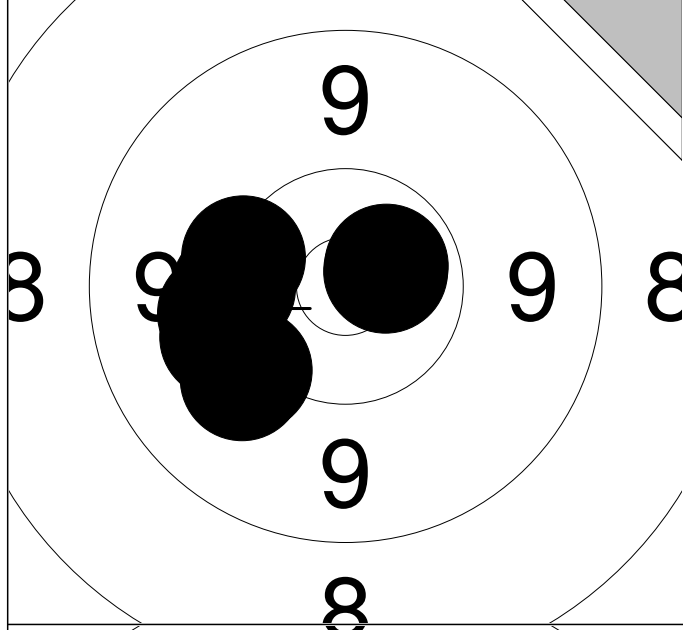

1:	*10.6	↗
2:	10.1	↖
3:	10.0	↙
4:	10.1	↘
5:	10.2	↖
6:	10.1	↖
7:	10.2	↗
8:	*10.7	↗
Serie		80.0
Total		0.0

Gældende

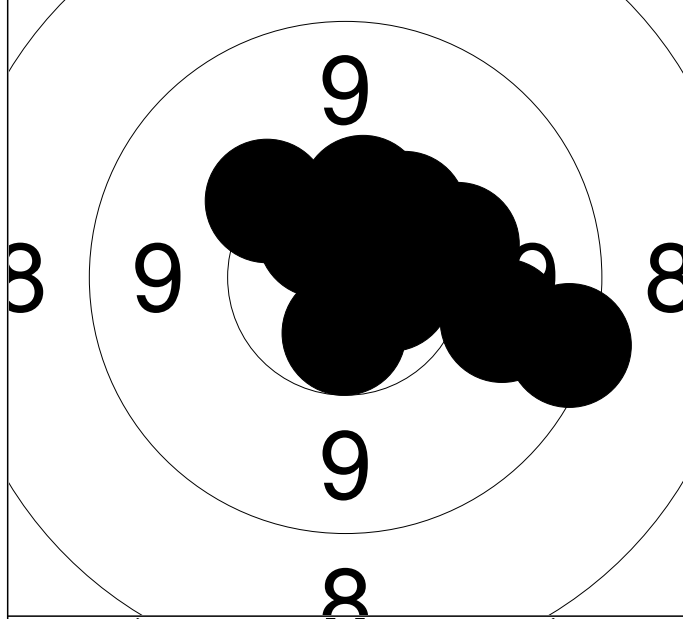

1:	*10.6	↗
2:	*10.7	↗
3:	*10.6	→
4:	*10.6	↘
5:	9.3	→
6:	10.2	→
7:	10.2	↗
8:	10.4	↗
9:	10.4	↗
10:	9.9	→
Serie		98.0
Total		98.0

Gældende

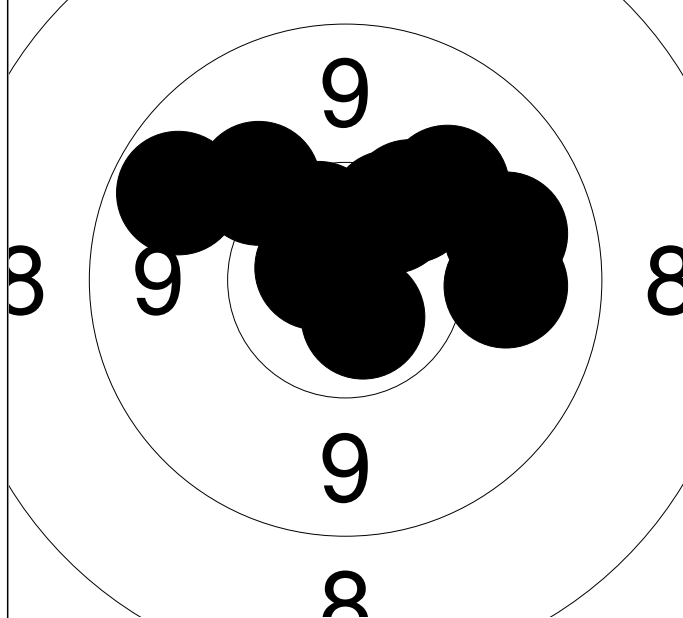

11:	10.3	↗
12:	*10.7	↘
13:	9.8	→
14:	10.0	↗
15:	9.9	→
16:	10.4	↗
17:	*10.7	↗
18:	10.1	↗
19:	*10.5	↗
20:	9.7	↗
Serie		97.0
Total		195.0

Prøveskud

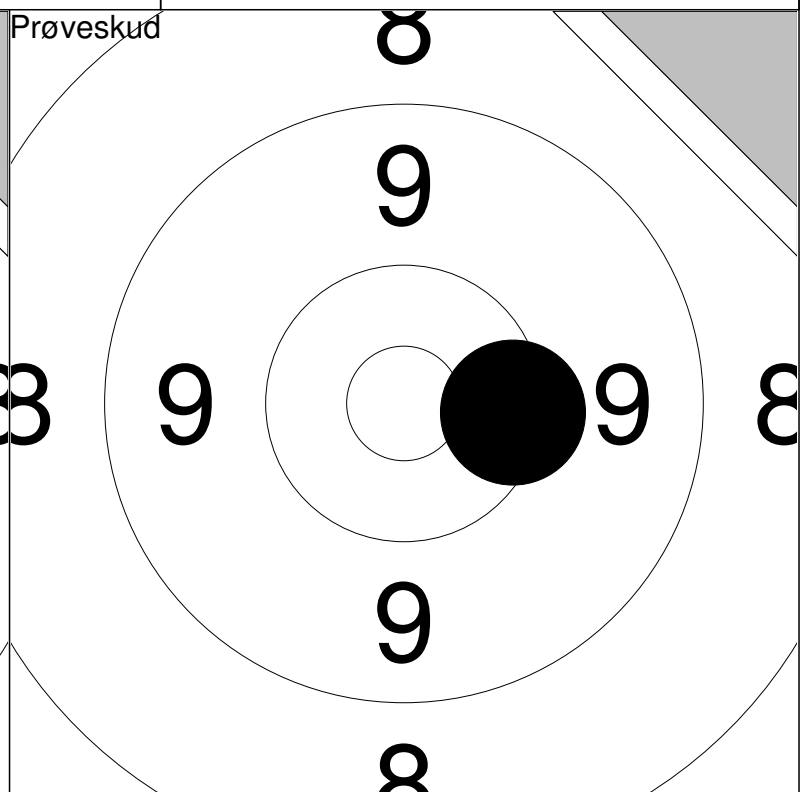
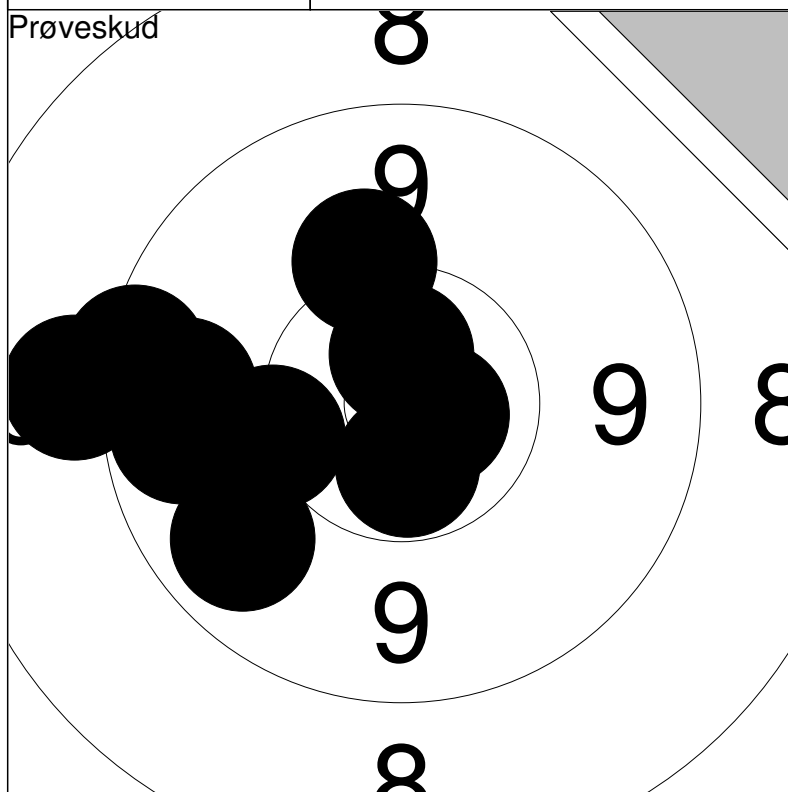

1: *10.6	↓	6: *10.7	→	Serie	95.0
2: 9.7	←	7: 9.0	←		
3: 10.1	↑	8: 9.7	↙	Total	0.0
4: 9.4	←	9: 9.7	←		
5: 10.2	←	10: *10.7	↑		

11: 10.3	→	Serie	10.0
		Total	0.0

Gældende

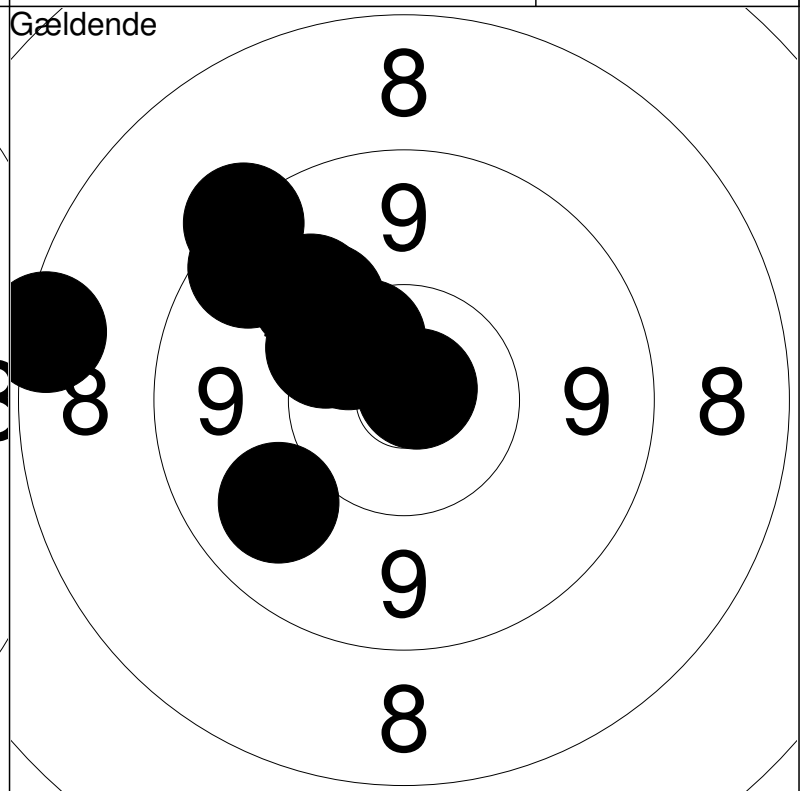
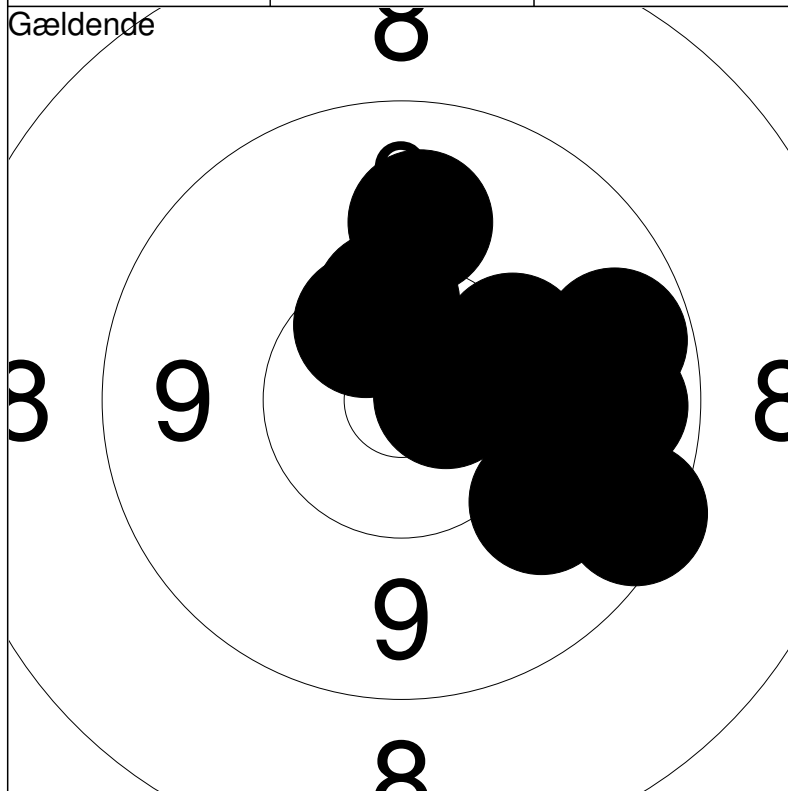

1: 9.7	→	6: 9.4	↘	Serie	96.0
2: *10.7	→	7: 10.0	↘		
3: 9.7	→	8: 10.4	↑	Total	96.0
4: 10.1	→	9: 9.9	↑		
5: 10.2	↗	10: *10.5	↗		

11: 8.3	←	16: 9.5	↗	Serie	95.0
12: 10.0	↗	17: 9.8	↙		
13: 10.1	↗	18: 10.3	↗	Total	191.0
14: 9.3	↗	19: *10.5	↗		
15: *10.4	↗	20: *10.8	↗		

Prøveskud

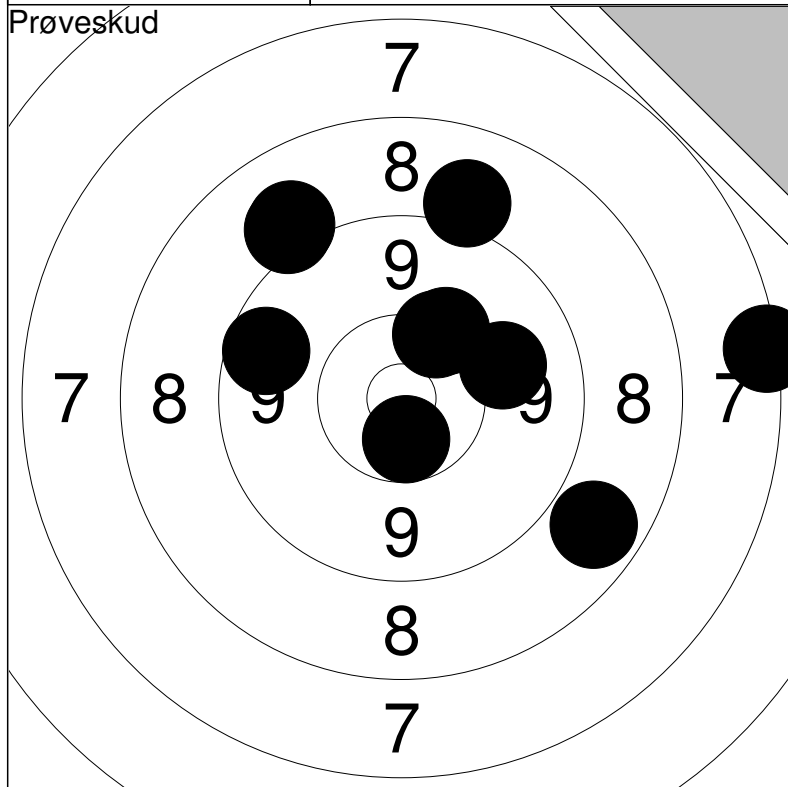

Prøveskud

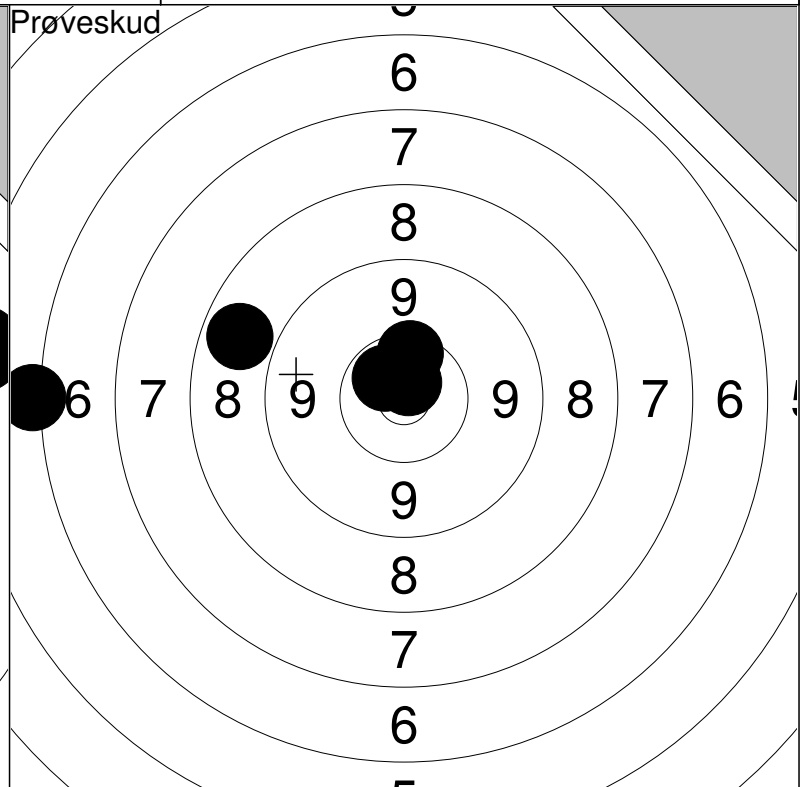

1:	7.3	→
2:	8.9	↑
3:	8.7	↘
4:	8.9	↗
5:	9.6	↖

6:	*10.6	↓
7:	10.3	↗
8:	9.9	→
9:	9.0	↖
10:	10.2	↗

Serie	88.0	
Total	0.0	

11:	8.7	↖
12:	6.1	←
13:	*10.6	↖
14:	10.4	↑
15:	*10.7	↑

Serie	44.0	
Total	0.0	

Gældende

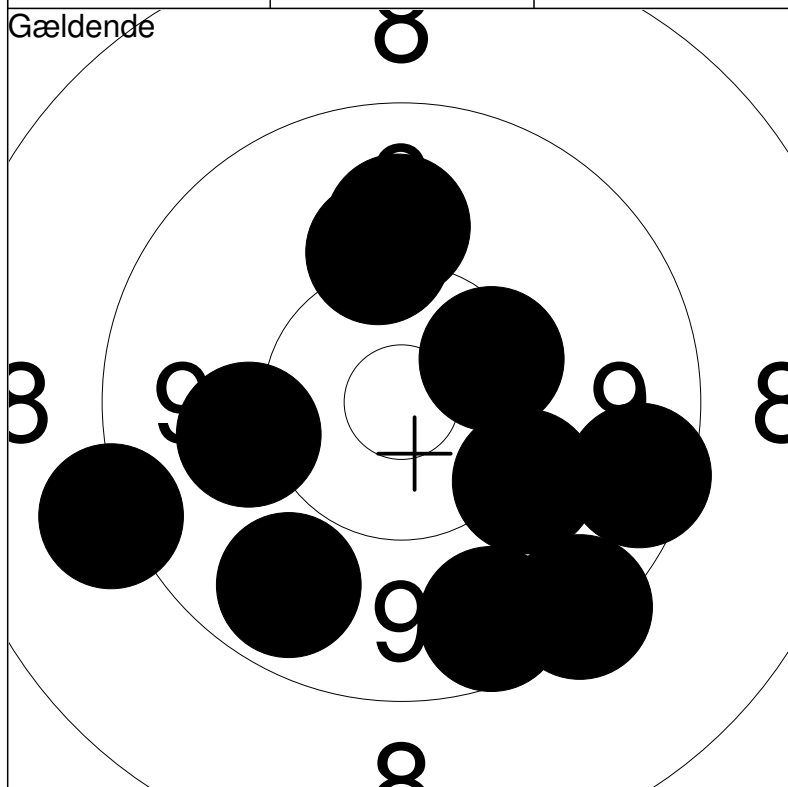

Gældende

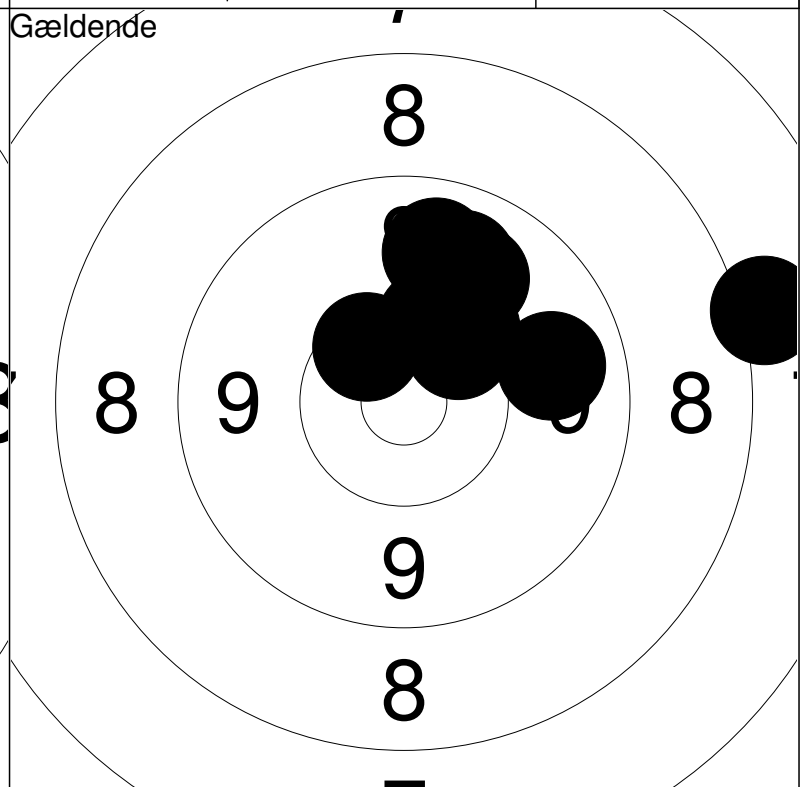

1:	9.6	↘
2:	9.3	↘
3:	10.4	↗
4:	9.9	↑
5:	10.1	↑

6:	10.1	←
7:	9.1	←
8:	9.7	↘
9:	9.5	↘
10:	10.1	↘

Serie	94.0	
Total	94.0	

11:	10.2	↗
12:	9.9	↗
13:	*10.4	↖
14:	8.0	→
15:	10.0	↑

16:	10.3	↗
17:	9.8	↑
18:	9.8	→
19:	10.3	↑
20:	9.8	↑

Serie	94.0	
Total	188.0	

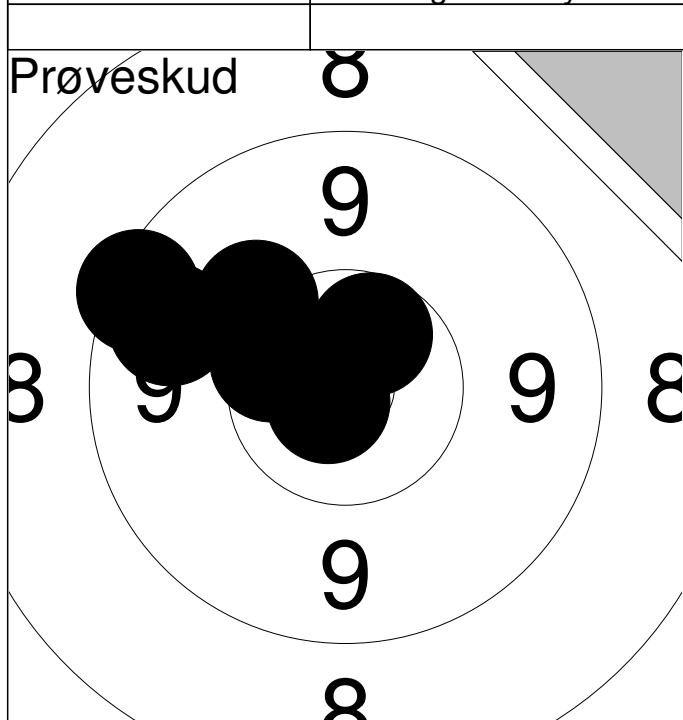

1:	*10.8	↙
2:	9.7	↗
3:	*10.4	↗
4:	10.1	↗
5:	9.4	↗
6:	*10.6	↗
Serie		58.0
Total		0.0

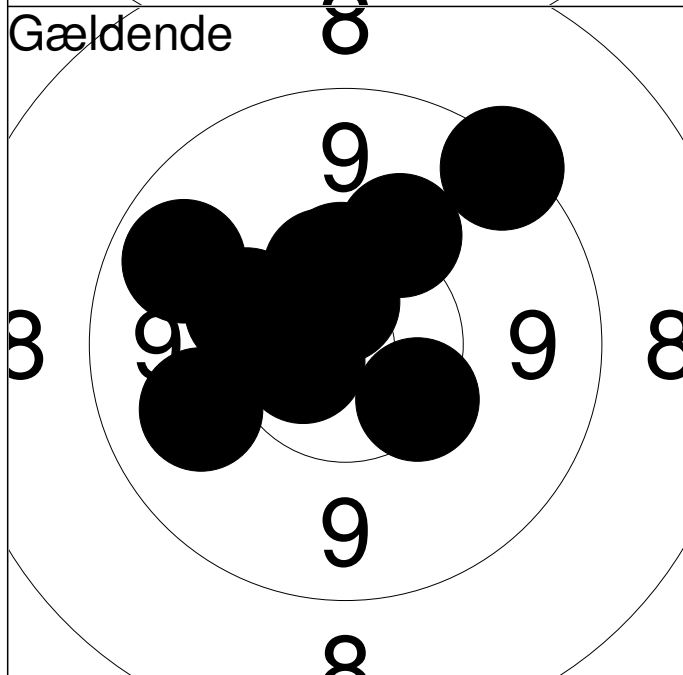

1:	10.1	↗
2:	9.7	↖
3:	*10.4	↗
4:	9.3	↗
5:	10.3	↘
6:	*10.7	↗
7:	*10.4	↗
8:	*10.6	↖
9:	9.9	↖
10:	10.2	↖
Serie		97.0
Total		97.0

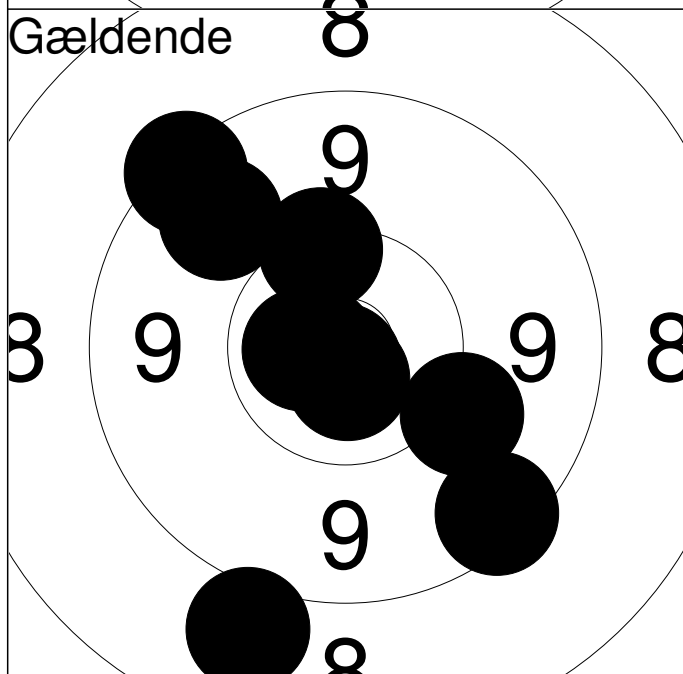

11:	*10.7	↖
12:	10.3	↗
13:	*10.8	↘
14:	*10.7	↖
15:	10.1	↘
16:	8.9	↖
17:	9.3	↗
18:	9.4	↘
19:	9.7	↗
20:	*10.7	↘
Serie		95.0
Total		192.0

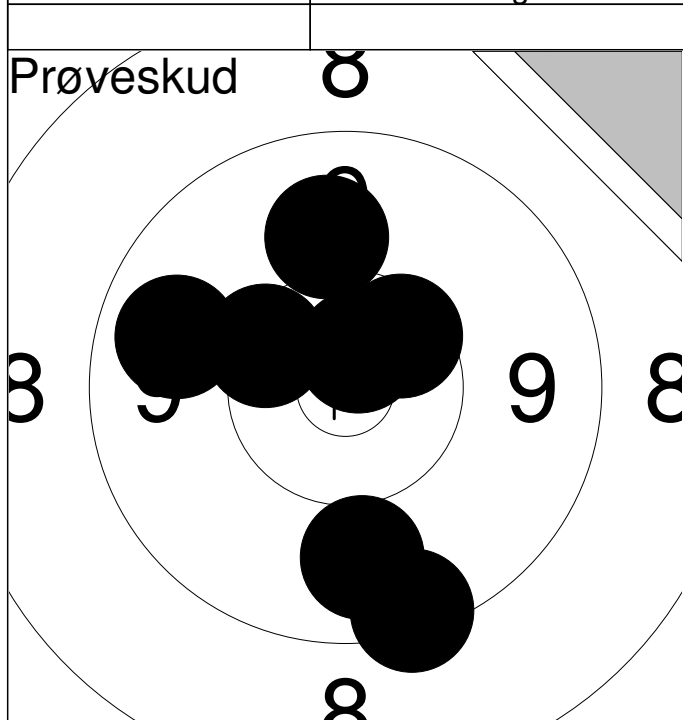

1:	9.8	↓
2:	9.3	↓
3:	9.9	↑
4:	*10.7	↑
5:	9.8	↖
6:	10.3	↖
7:	*10.4	↗
Serie		66.0
Total		0.0

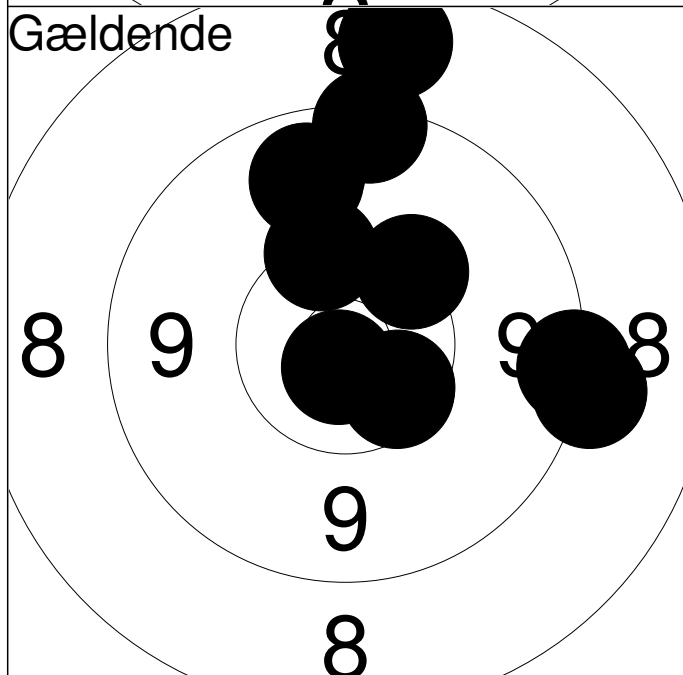

1:	9.3	↑
2:	10.2	↗
3:	9.1	→
4:	*10.4	↓
5:	*10.5	↓
6:	9.7	↑
7:	*10.8	↓
8:	8.6	↑
9:	9.2	→
10:	10.3	↑
Serie		94.0
Total		94.0

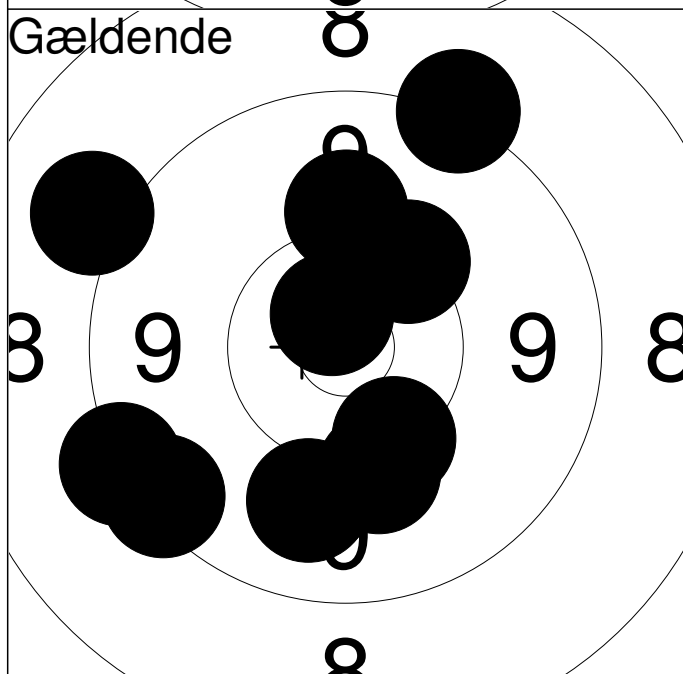

11:	9.2	↖
12:	10.1	↓
13:	10.3	↓
14:	10.2	↗
15:	9.9	↓
16:	9.3	↖
17:	9.0	↖
18:	9.1	↖
19:	10.0	↑
20:	*10.7	↑
Serie		95.0
Total		189.0

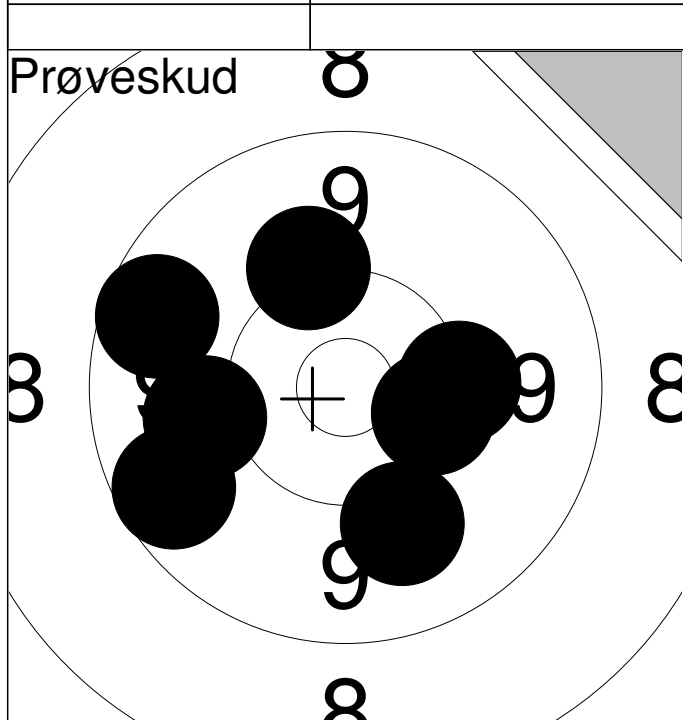

1:	10.1	↗
2:	10.3	→
3:	9.6	↖
4:	9.6	↖
5:	10.0	↘
6:	10.2	→
7:	10.0	↖
Serie		68.0
Total		0.0

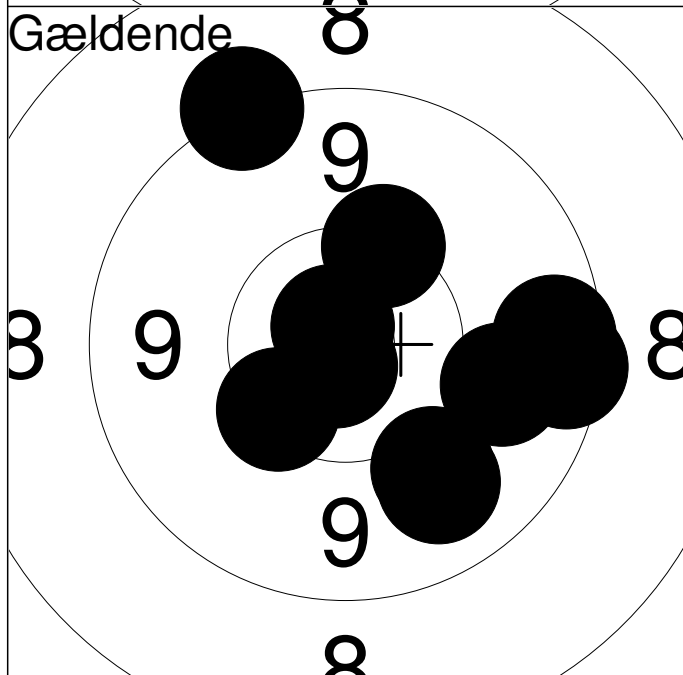

1:	9.9	→
2:	9.4	→
3:	9.9	↘
4:	9.8	↘
5:	*10.8	↗
6:	10.3	↖
7:	10.2	↖
8:	9.5	→
9:	9.2	↖
10:	*10.8	↘
Serie		94.0
Total		94.0

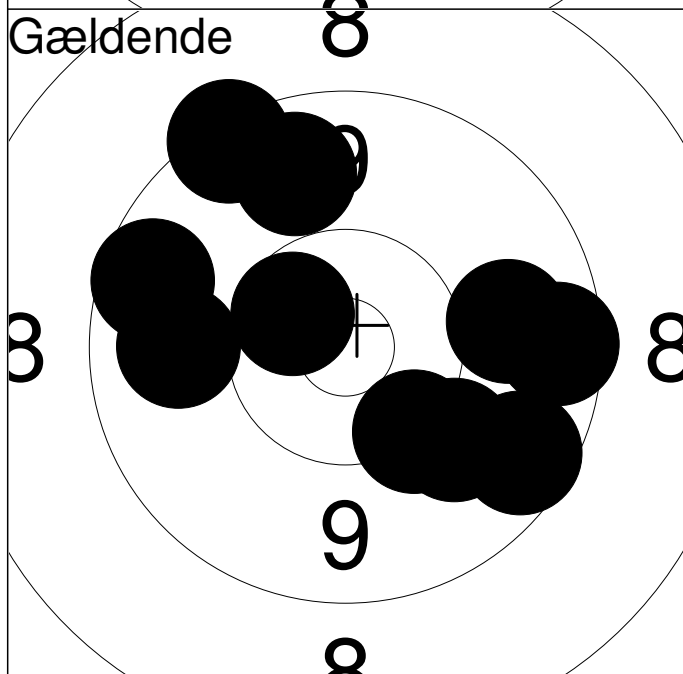

11:	9.8	←
12:	9.8	→
13:	9.3	↗
14:	*10.5	↗
15:	10.2	↘
16:	9.7	→
17:	9.6	↘
18:	9.5	→
19:	10.0	↘
20:	9.6	↖
Serie		93.0
Total		187.0

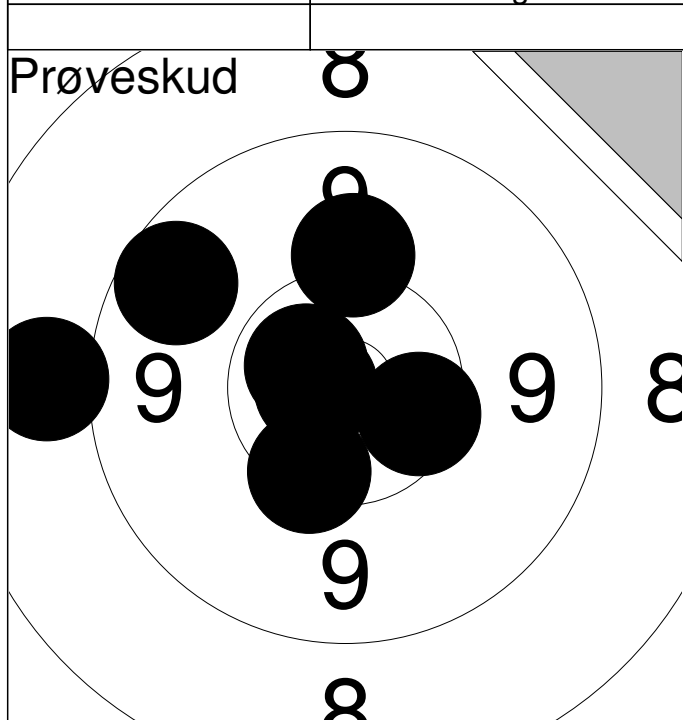

1:	8.9	←
2:	10.3	↙
3:	*10.4	→
4:	*10.6	↗
5:	9.6	↗
6:	10.1	↑
7:	*10.8	←
Serie		67.0
Total		0.0

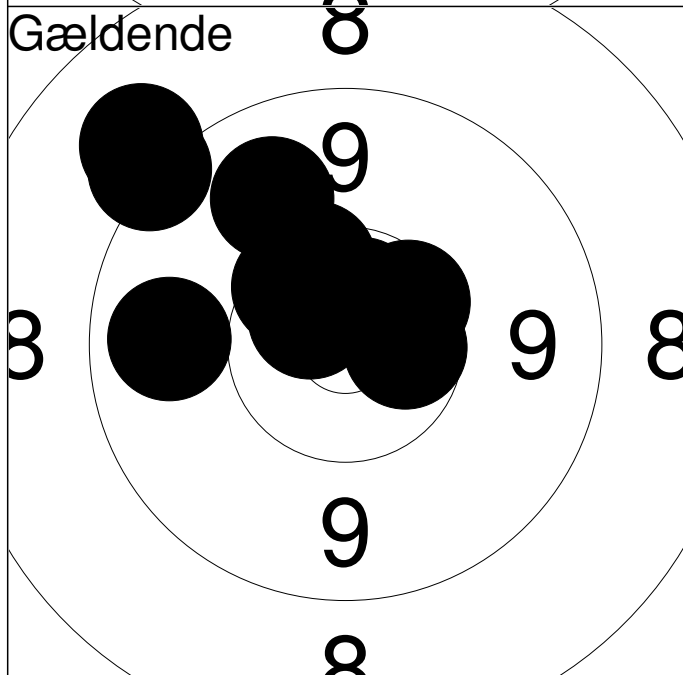

1:	*10.4	↗
2:	9.0	↗
3:	9.8	←
4:	*10.6	↗
5:	9.8	↗
6:	*10.6	↗
7:	10.4	↗
8:	*10.6	→
9:	*10.4	↗
10:	9.1	↗
Serie		96.0
Total		96.0

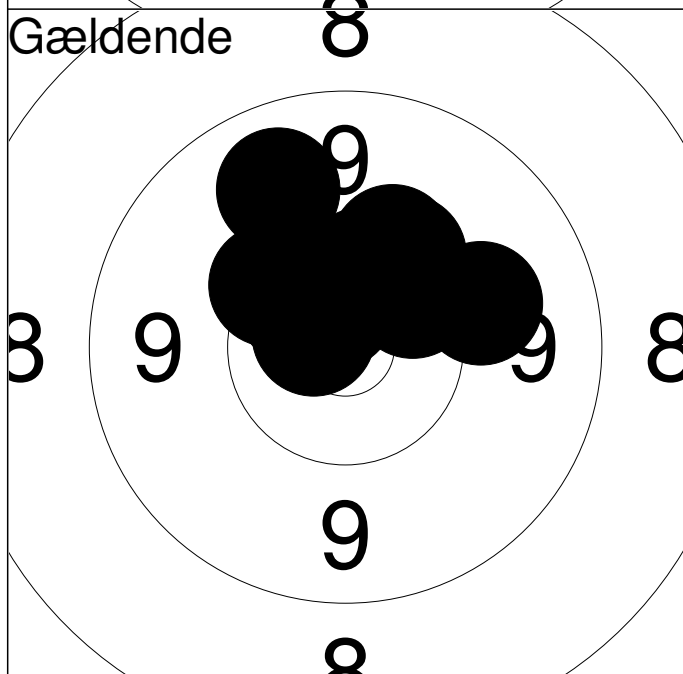

11:	9.8	↗
12:	10.4	↑
13:	10.2	↗
14:	10.0	→
15:	10.2	↗
16:	*10.7	←
17:	10.3	↗
18:	10.4	↗
19:	*10.5	↗
20:	*10.7	↑
Serie		99.0
Total		195.0

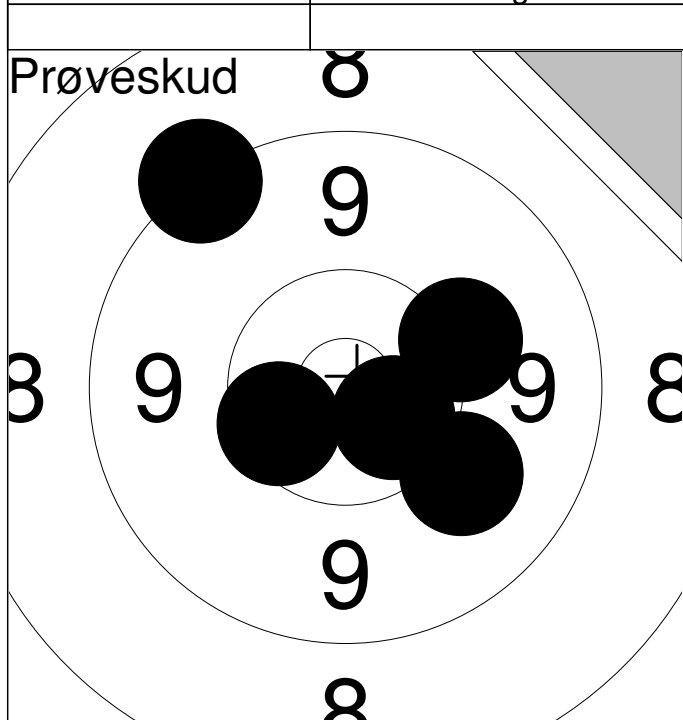

1:	*10.4	↖
2:	10.0	↘
3:	9.2	↗
4:	10.1	→
5:	*10.6	↙
Serie		49.0
Total		0.0

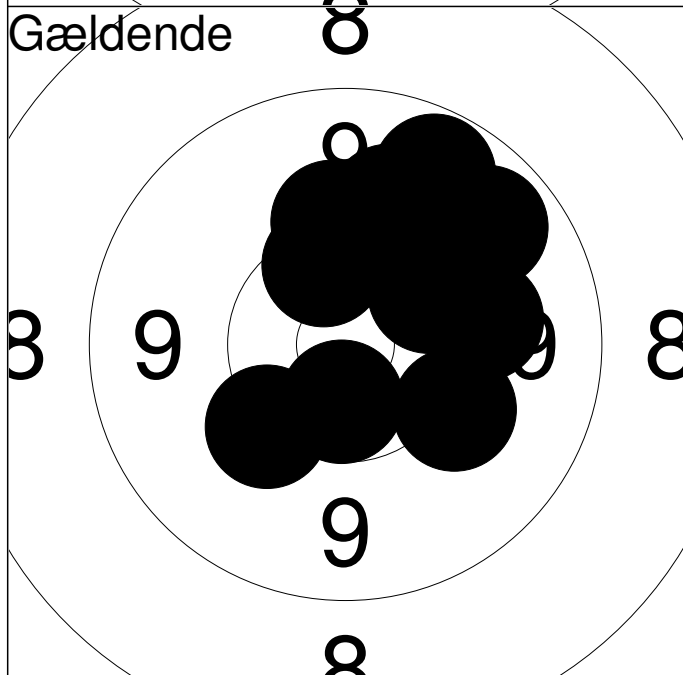

1:	10.1	↘
2:	10.4	↑
3:	*10.6	↓
4:	10.1	↑
5:	10.3	↗
6:	9.7	↗
7:	10.0	↑
8:	10.2	↖
9:	10.0	→
10:	9.7	↗
Serie		98.0
Total		98.0

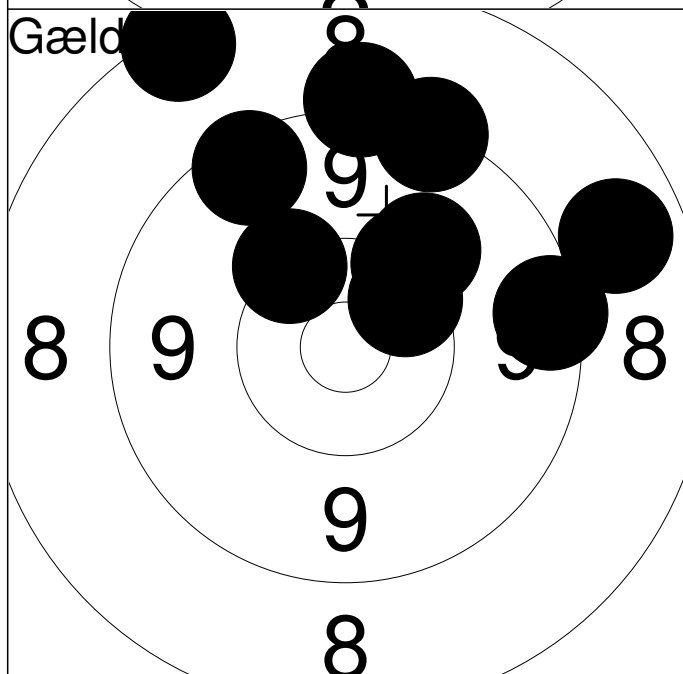

11:	10.4	↗
12:	9.4	→
13:	9.1	↑
14:	10.0	↗
15:	10.2	↗
16:	9.2	↑
17:	8.3	↑
18:	10.2	↑
19:	9.4	↑
20:	8.7	→
Serie		92.0
Total		190.0

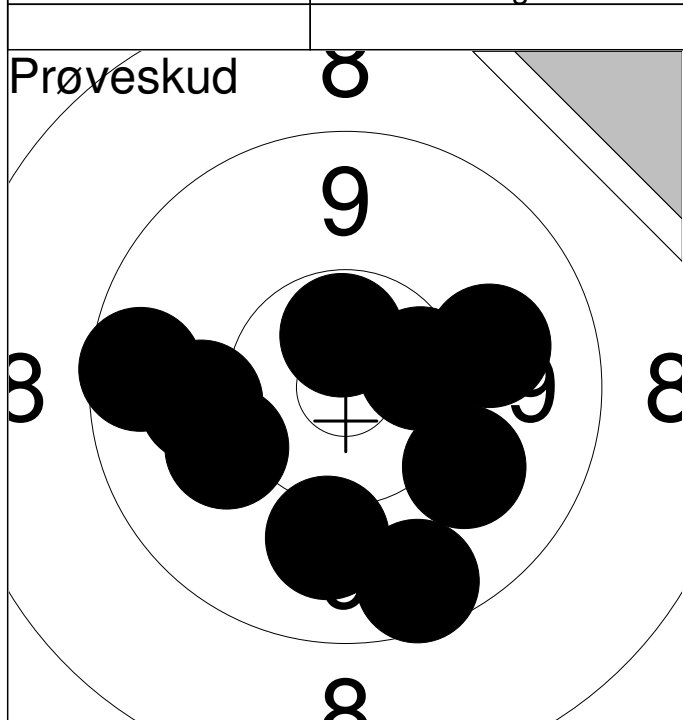

1:	9.5	←
2:	10.0	←
3:	10.1	←
4:	9.9	↓
5:	10.0	↘
6:	*10.4	→
7:	9.5	↓
8:	9.9	→
9:	*10.6	↑
Serie		86.0
Total		0.0

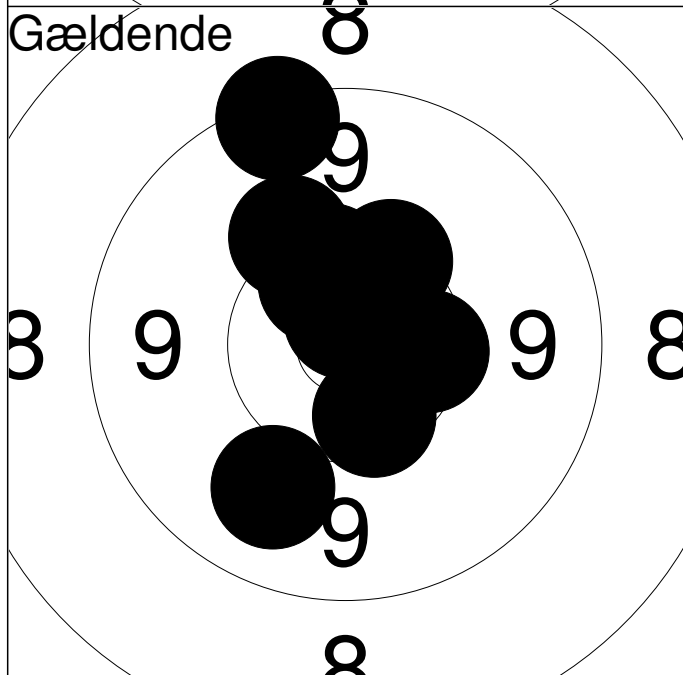

1:	10.4	↑
2:	9.9	↓
3:	*10.4	↓
4:	10.1	↗
5:	*10.8	↑
6:	10.4	→
7:	10.3	↗
8:	9.3	↑
9:	*10.6	↗
10:	*10.5	↑
Serie		98.0
Total		98.0

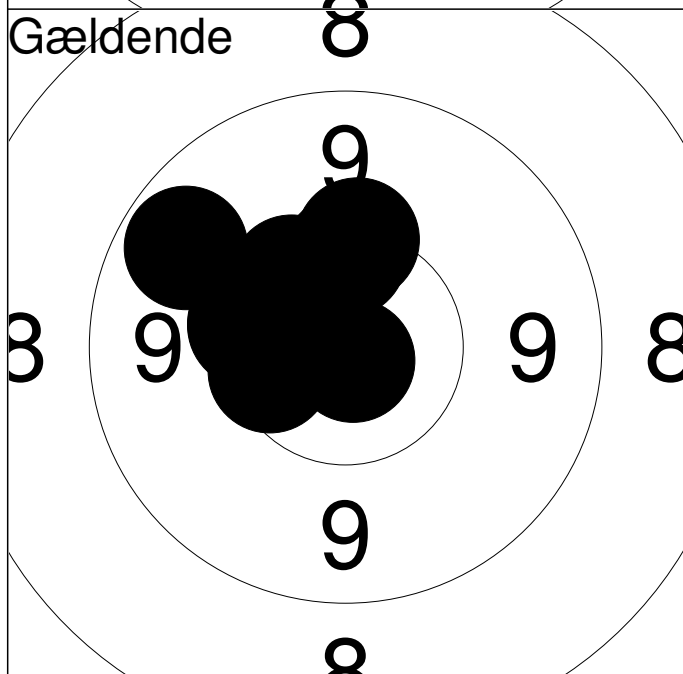

11:	10.2	↑
12:	10.3	←
13:	10.4	↗
14:	10.4	↗
15:	10.3	↑
16:	10.3	←
17:	*10.6	↗
18:	*10.8	↓
19:	*10.4	←
20:	9.7	↗
Serie		99.0
Total		197.0

Prøveskud / Prøveskud

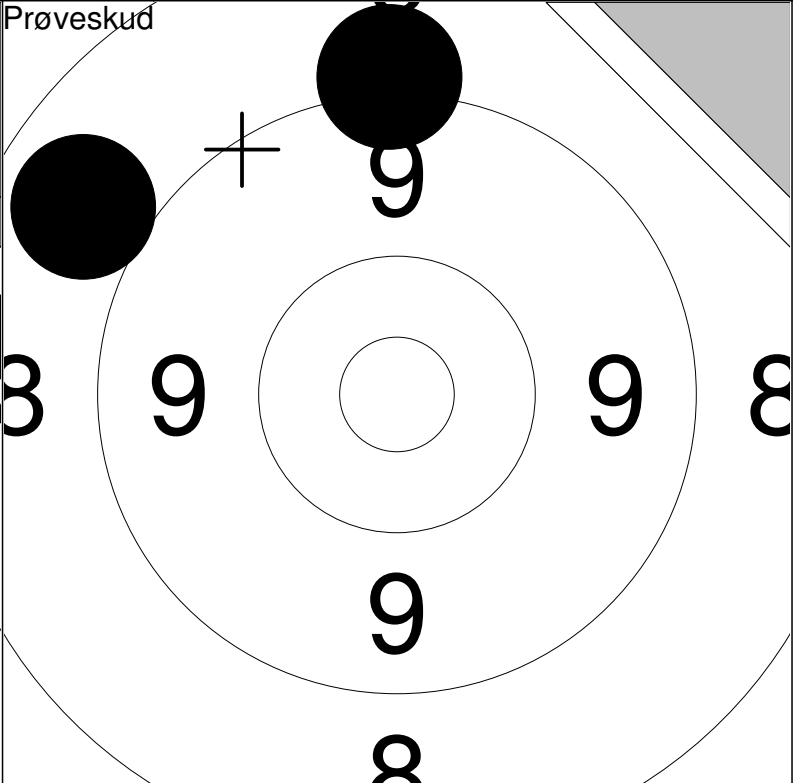
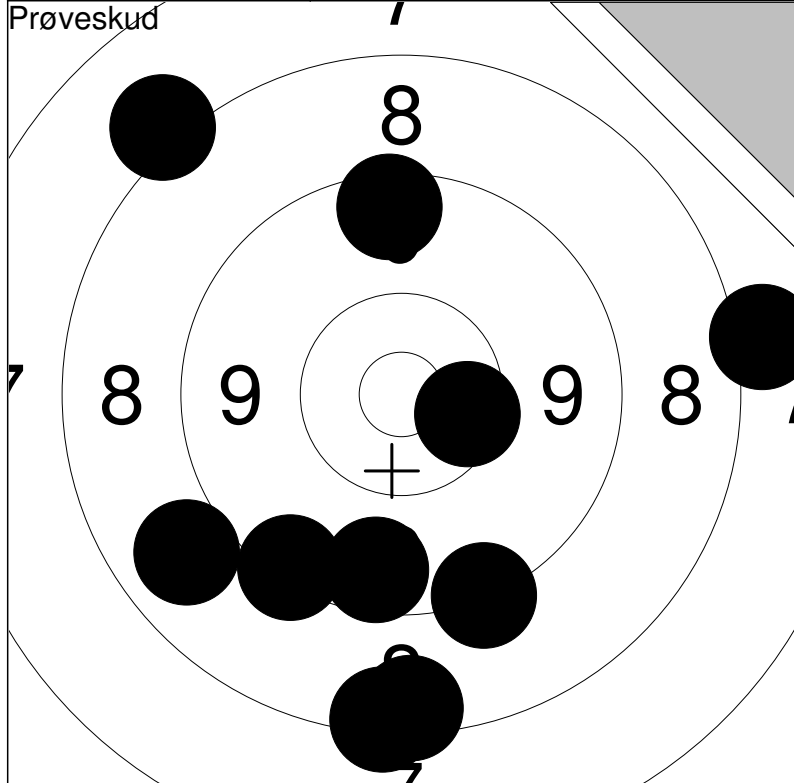

1: 9.4	↑	6: *10.4	→	Serie	86.0
2: 9.5	↓	7: 8.0	↗		
3: 8.3	↓	8: 8.8	↙	Total	0.0
4: 9.3	↙	9: 8.0	→		
5: 8.4	↓	10: 9.2	↘		

11: 8.8	↖	Serie	17.0
12: 9.1	↑		
		Total	0.0

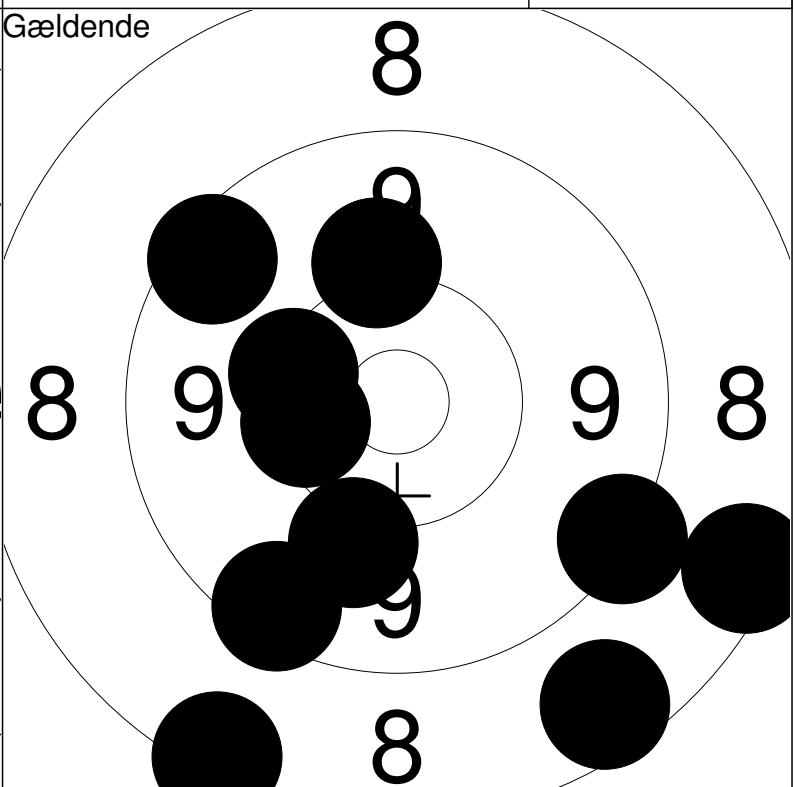
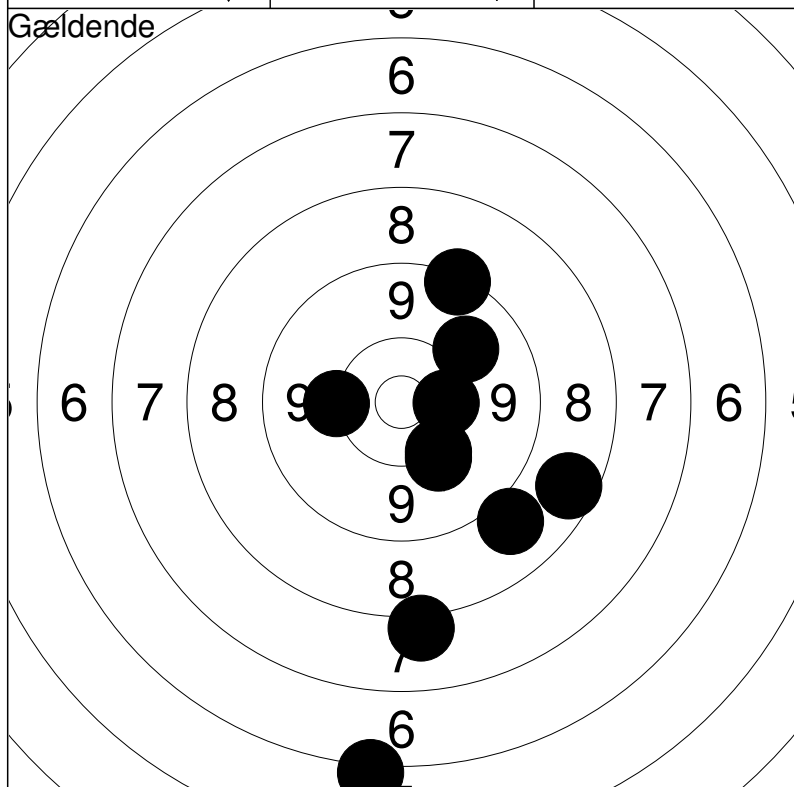

1: 10.2	↘	6: 8.0	↓	Serie	88.0
2: 6.1	↓	7: 8.9	↘		
3: 10.4	→	8: 10.1	←	Total	88.0
4: 9.3	↗	9: 9.9	↗		
5: 8.5	↘	10: 10.1	↘		

11: 8.4	→	16: 8.3	↘	Serie	91.0
12: 10.4	←	17: 9.4	↗		
13: 10.0	↓	18: 10.1	↑	Total	179.0
14: 9.2	↘	19: 10.3	↖		
15: 9.4	↘	20: 8.5	↘		

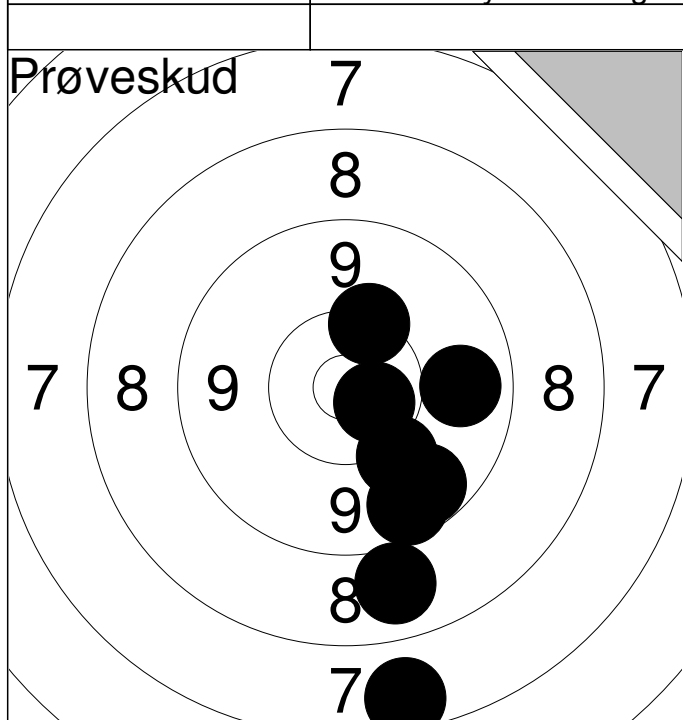

1:	9.6	↘
2:	7.5	↘
3:	8.8	↘
4:	9.8	→
5:	*10.6	↘
6:	10.1	↘
7:	10.3	↗
8:	9.6	↘
Serie		72.0
Total		0.0

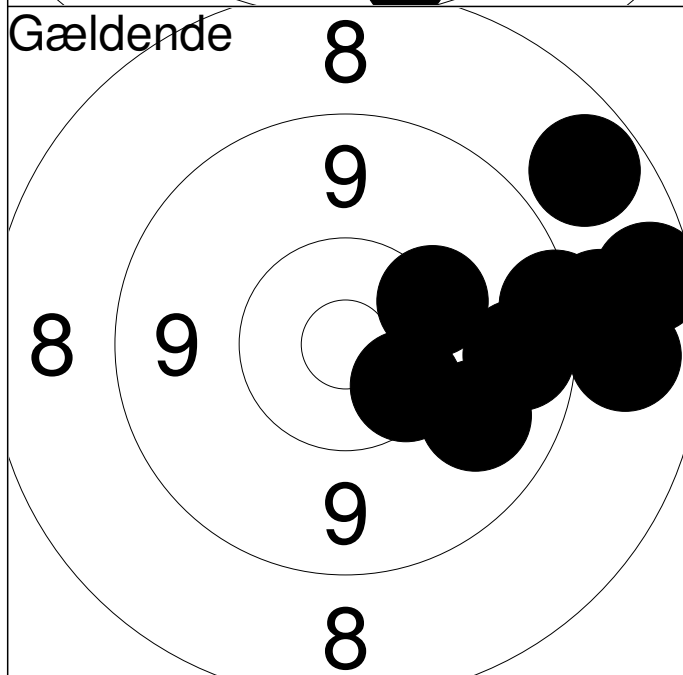

1:	9.8	↘
2:	10.2	↗
3:	9.6	→
4:	10.4	↘
5:	8.7	↗
6:	8.8	→
7:	9.0	→
8:	8.5	→
9:	9.0	→
10:	9.3	→
Serie		89.0
Total		89.0

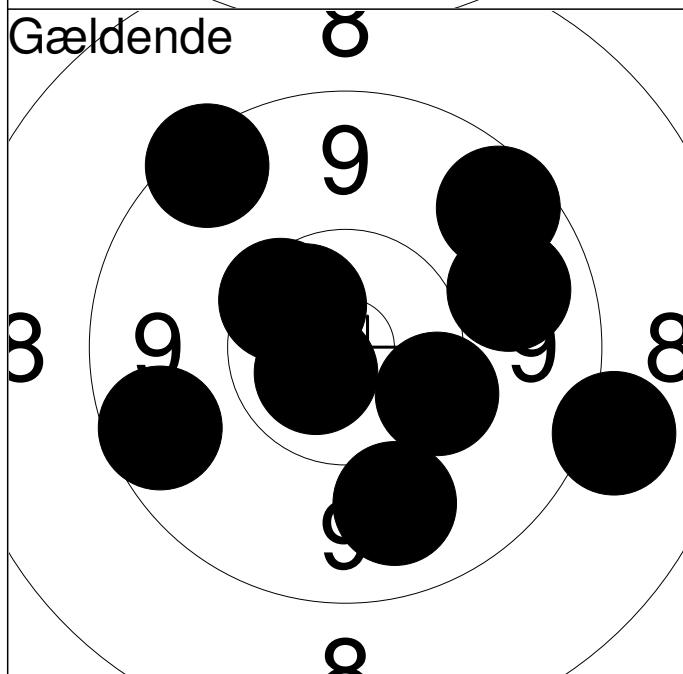

11:	9.8	↗
12:	*10.6	↗
13:	*10.4	↗
14:	10.3	↘
15:	9.5	↗
16:	9.4	↗
17:	*10.7	↖
18:	9.8	↘
19:	9.6	↖
20:	9.0	↘
Serie		94.0
Total		183.0

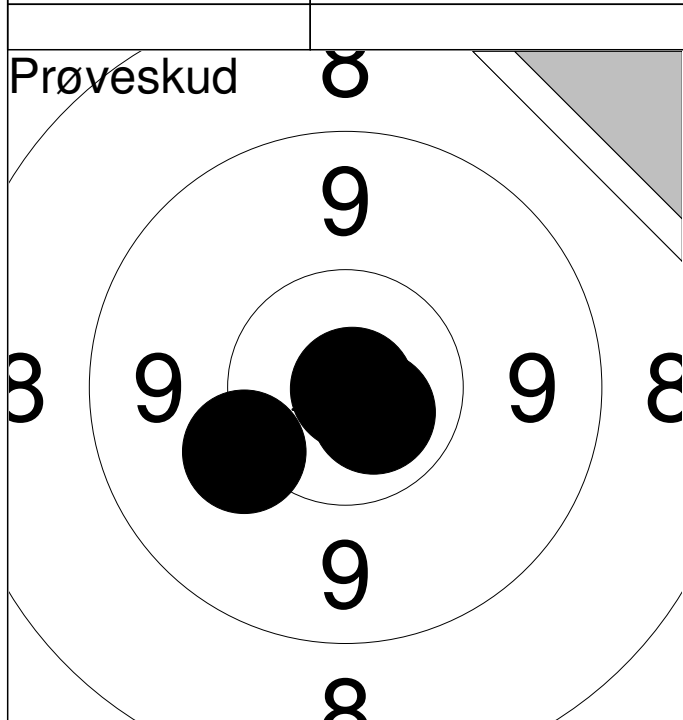

	1:	*10.9	→
	2:	10.1	←
	3:	*10.7	↘
Serie			30.0
Total			0.0

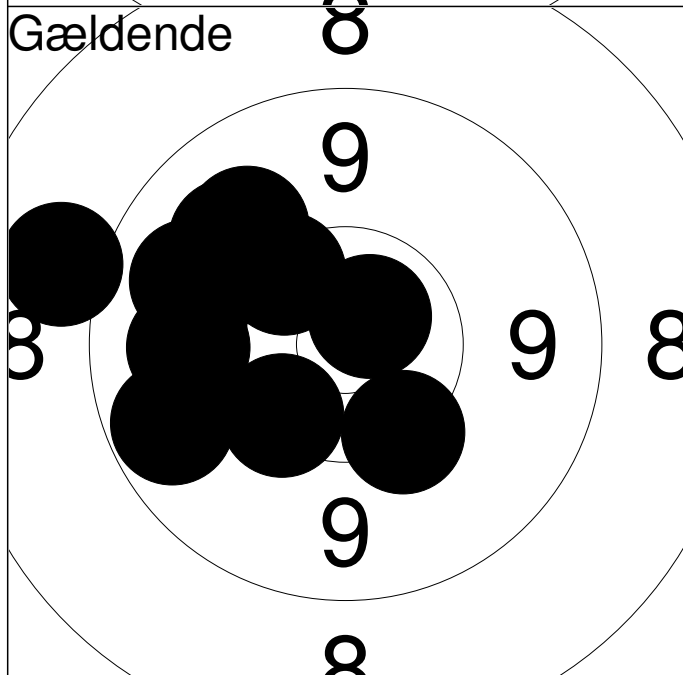

	1:	9.9	↗
	2:	8.9	↗
	3:	9.9	←
	4:	9.7	↖
	5:	9.9	↗
	6:	*10.7	↗
	7:	10.3	↗
	8:	10.2	↘
	9:	10.3	↘
	10:	9.8	↗
Serie			93.0
Total			93.0

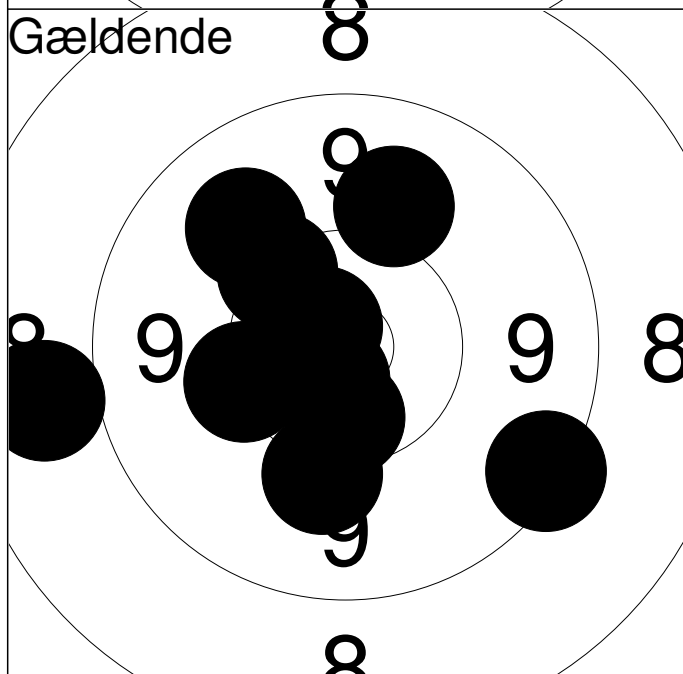

	11:	10.1	↘
	12:	9.9	↗
	13:	10.3	↗
	14:	9.3	↘
	15:	*10.5	←
	16:	*10.7	↗
	17:	8.8	←
	18:	10.2	←
	19:	9.9	↗
	20:	*10.7	↘
Serie			95.0
Total			188.0

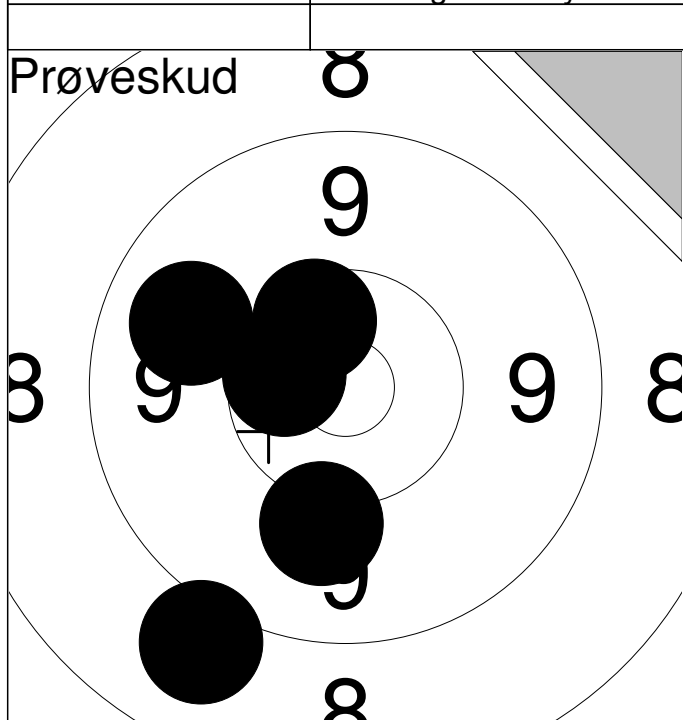

	1:	8.9		↙
	2:	9.8		↗
	3:	10.0		↘
	4:	*10.5		↖
	5:	*10.5		↗
Serie				47.0
Total				0.0

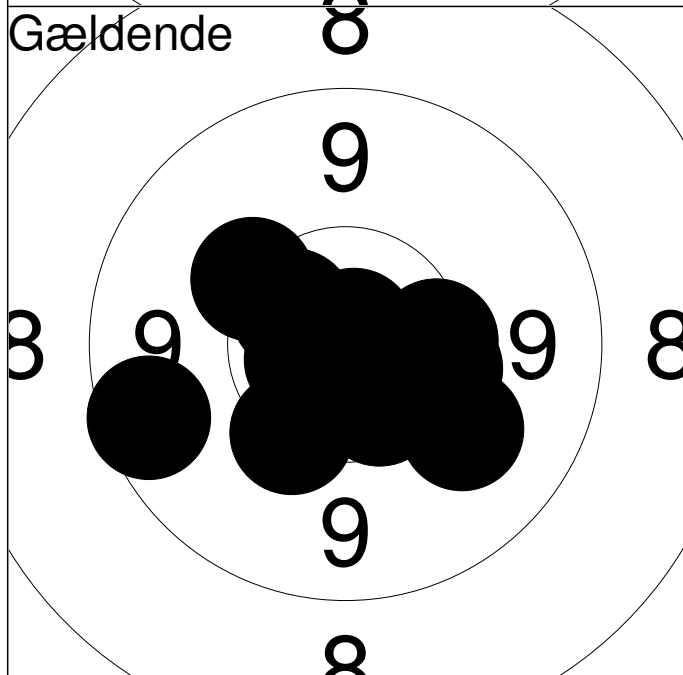

	1:	9.5		↖
	2:	*10.5		↗
	3:	*10.7		↖
	4:	10.3		↘
	5:	*10.5		↘
	6:	10.3		→
	7:	10.2		↗
	8:	10.0		↘
	9:	10.3		→
	10:	*10.8		↗
Serie				99.0
Total				99.0

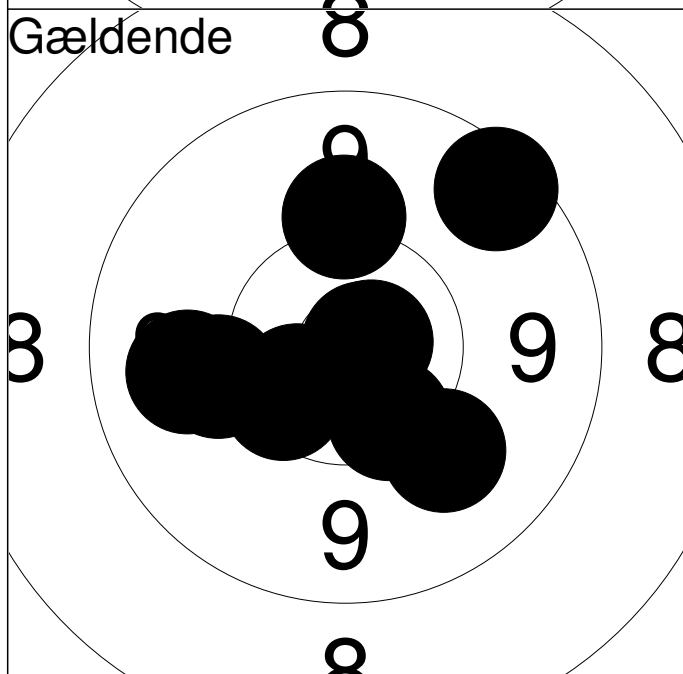

	11:	10.4		↖
	12:	10.1		↖
	13:	9.9		↖
	14:	*10.5		↖
	15:	10.1		↑
	16:	*10.8		→
	17:	10.0		↘
	18:	10.4		↘
	19:	*10.8		→
	20:	9.5		↗
Serie				98.0
Total				197.0

Vester Hassing Skf.

MB3

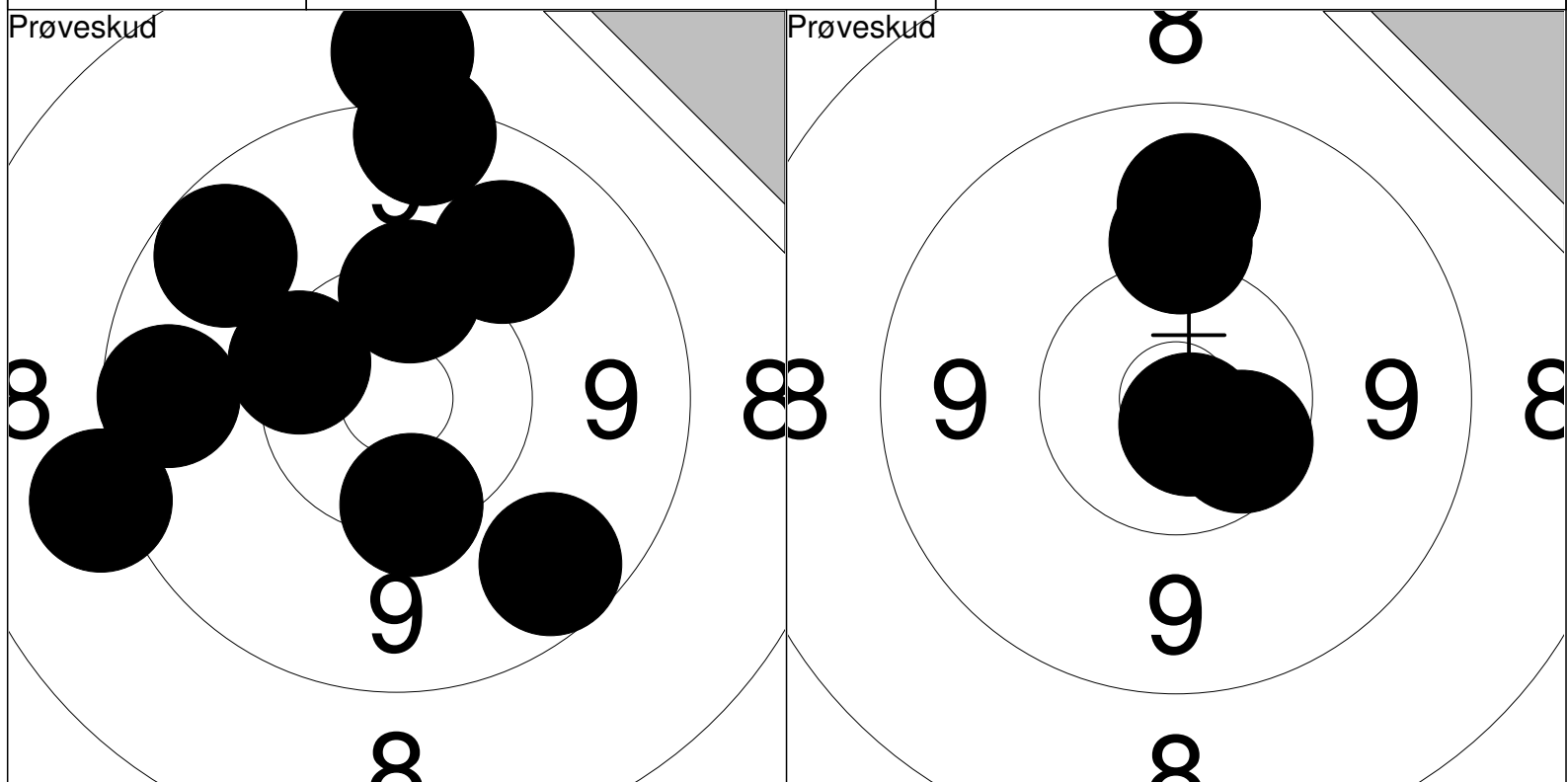

1: 9.9 ↗	6: 9.6 ↖		11: 10.0 ↑		
2: 10.3 ↑	7: 10.3 ↓	Serie	12: *10.5 ↓	92.0	Serie
3: 9.6 ↘	8: 10.3 ←		13: 9.8 ↑		
4: 9.4 ↑	9: 9.6 ←	Total	14: *10.8 ↓	0.0	Total
5: 8.8 ↑	10: 9.1 ←				0.0

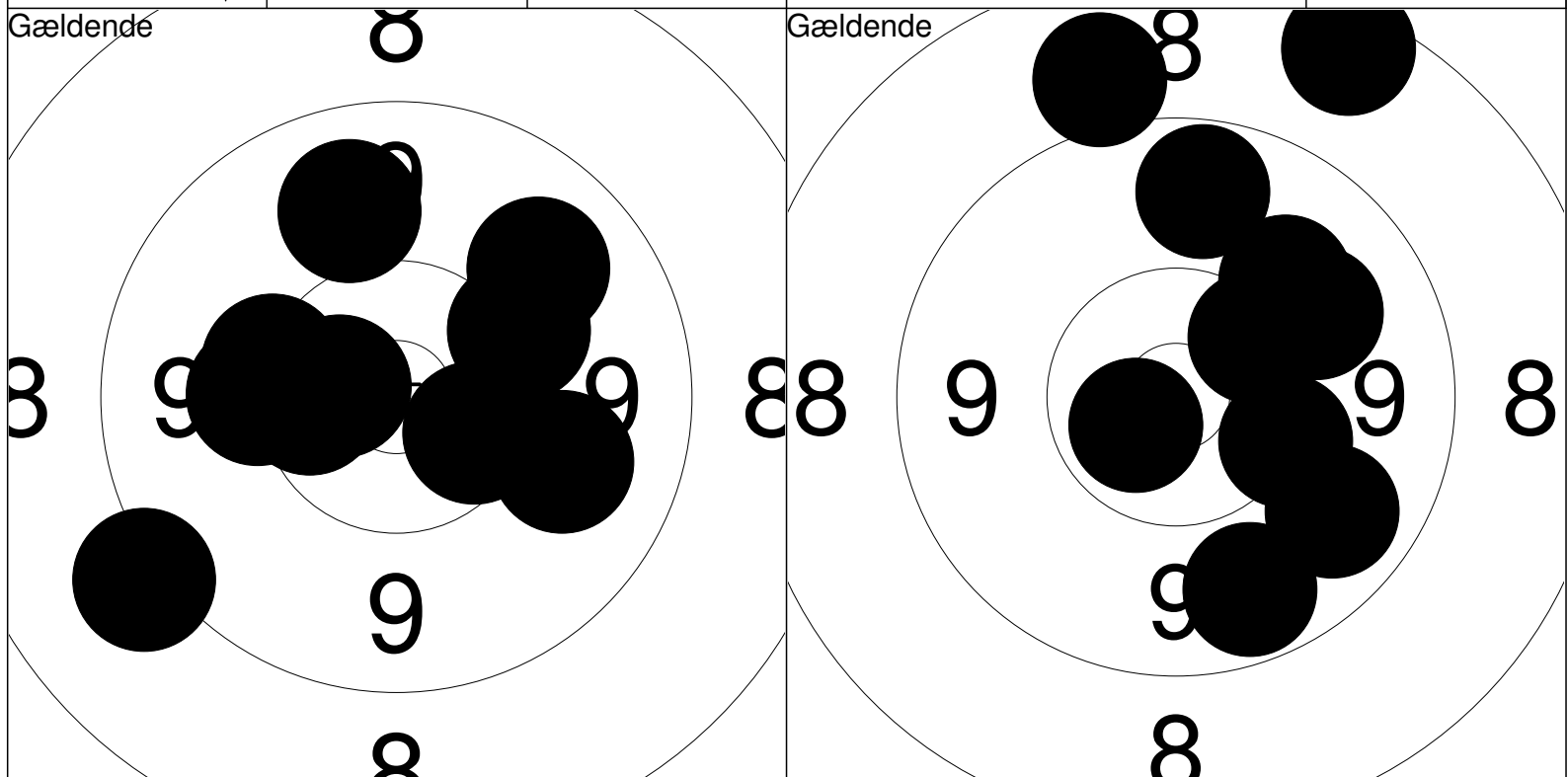

1: *10.4 ←	6: 10.1 ←		11: 10.2 →	16: 9.9 ↗	
2: 9.8 ↗	7: 9.8 ↑	Serie	12: 9.7 ↓	17: 9.7 ↑	Serie
3: 9.9 →	8: 9.1 ←		13: 10.3 ↗	18: 10.0 ↗	
4: *10.5 →	9: *10.6 ←	Total	14: 8.4 ↑	19: *10.6 ←	Total
5: 10.1 ↗	10: 10.2 ←	96.0	15: 8.9 ↑	20: 9.7 ↓	188.0

Prøveskud

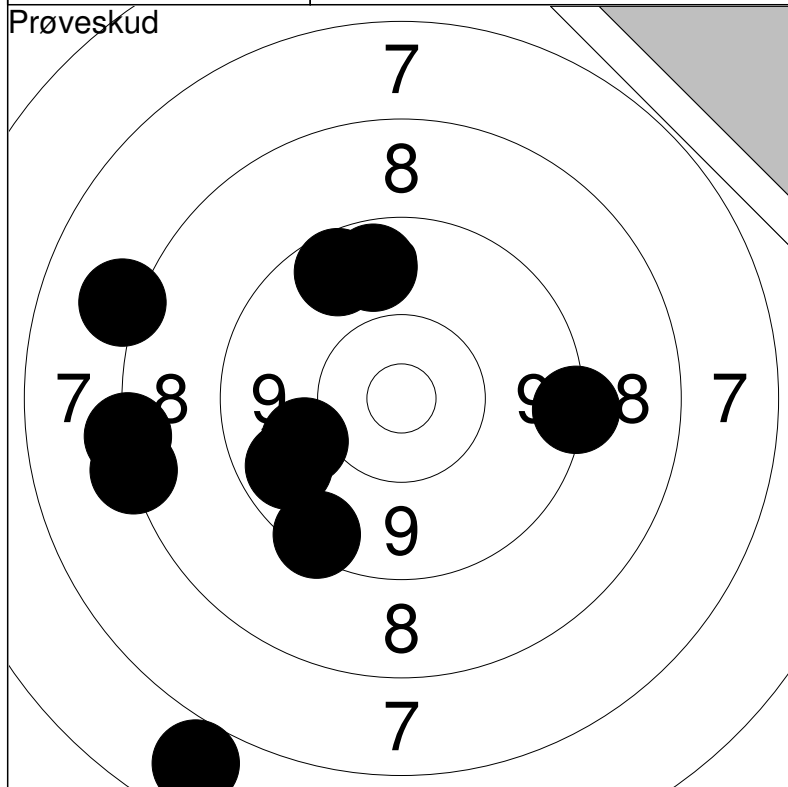

Prøveskud

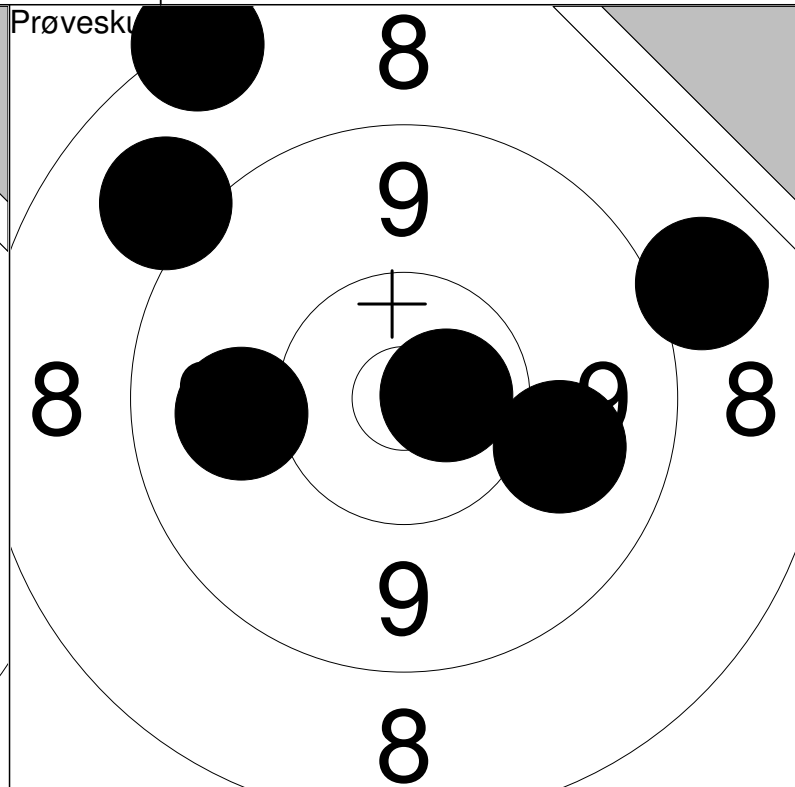

1:	6.7	↘
2:	8.2	←
3:	9.7	↙
4:	9.9	←
5:	8.2	←

6:	8.0	↖
7:	9.4	↘
8:	9.7	↑
9:	9.2	→
10:	9.6	↗

Serie	84.0
Total	0.0

11:	9.9	←
12:	8.2	↗
13:	8.9	→
14:	9.9	→
15:	*10.7	→

16:	8.9	↖
-----	-----	---

Serie	52.0
Total	0.0

Gældende

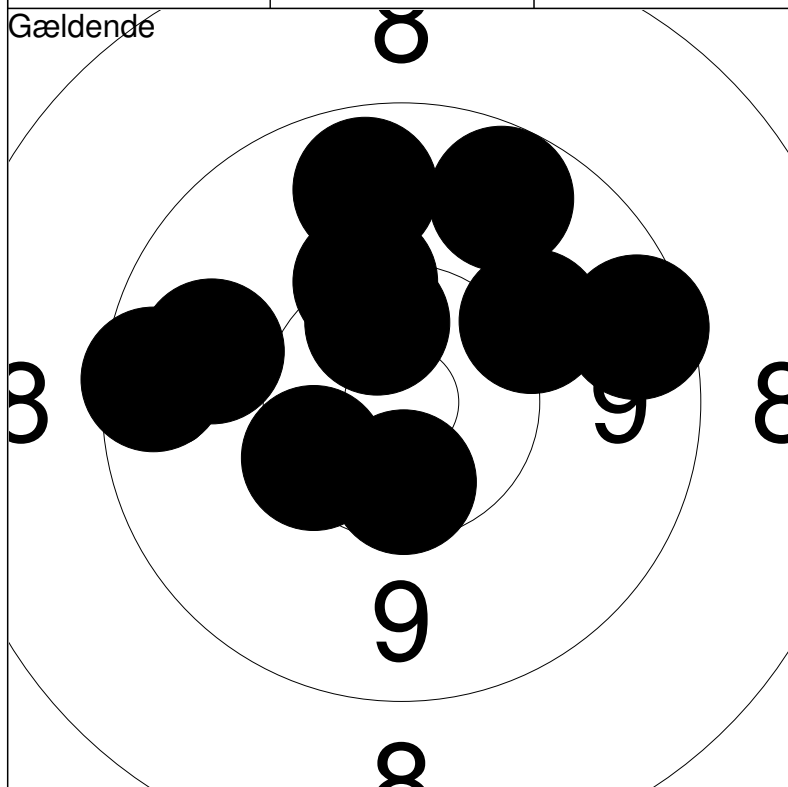

Gældende

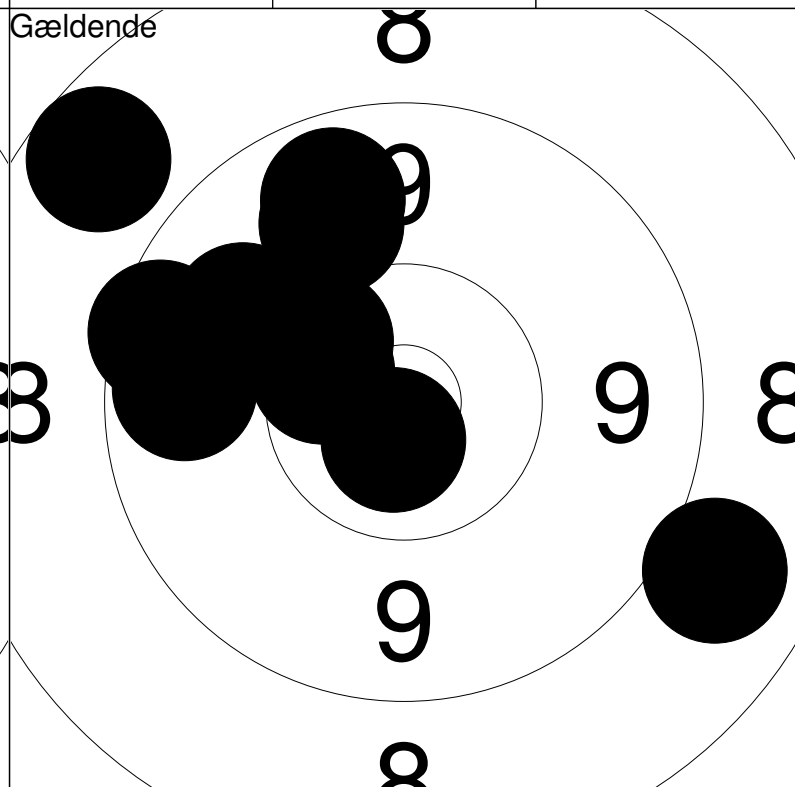

1:	9.8	←
2:	9.7	↑
3:	9.5	→
4:	*10.5	↑
5:	10.1	↗

6:	9.5	←
7:	10.4	↙
8:	*10.5	↓
9:	10.2	↑
10:	9.6	↗

Serie	95.0
Total	95.0

11:	10.4	↗
12:	9.5	←
13:	8.6	↗
14:	*10.5	←
15:	9.7	↑

16:	9.9	↗
17:	*10.7	↘
18:	9.7	←
19:	9.8	↑
20:	8.8	↘

Serie	91.0
Total	186.0

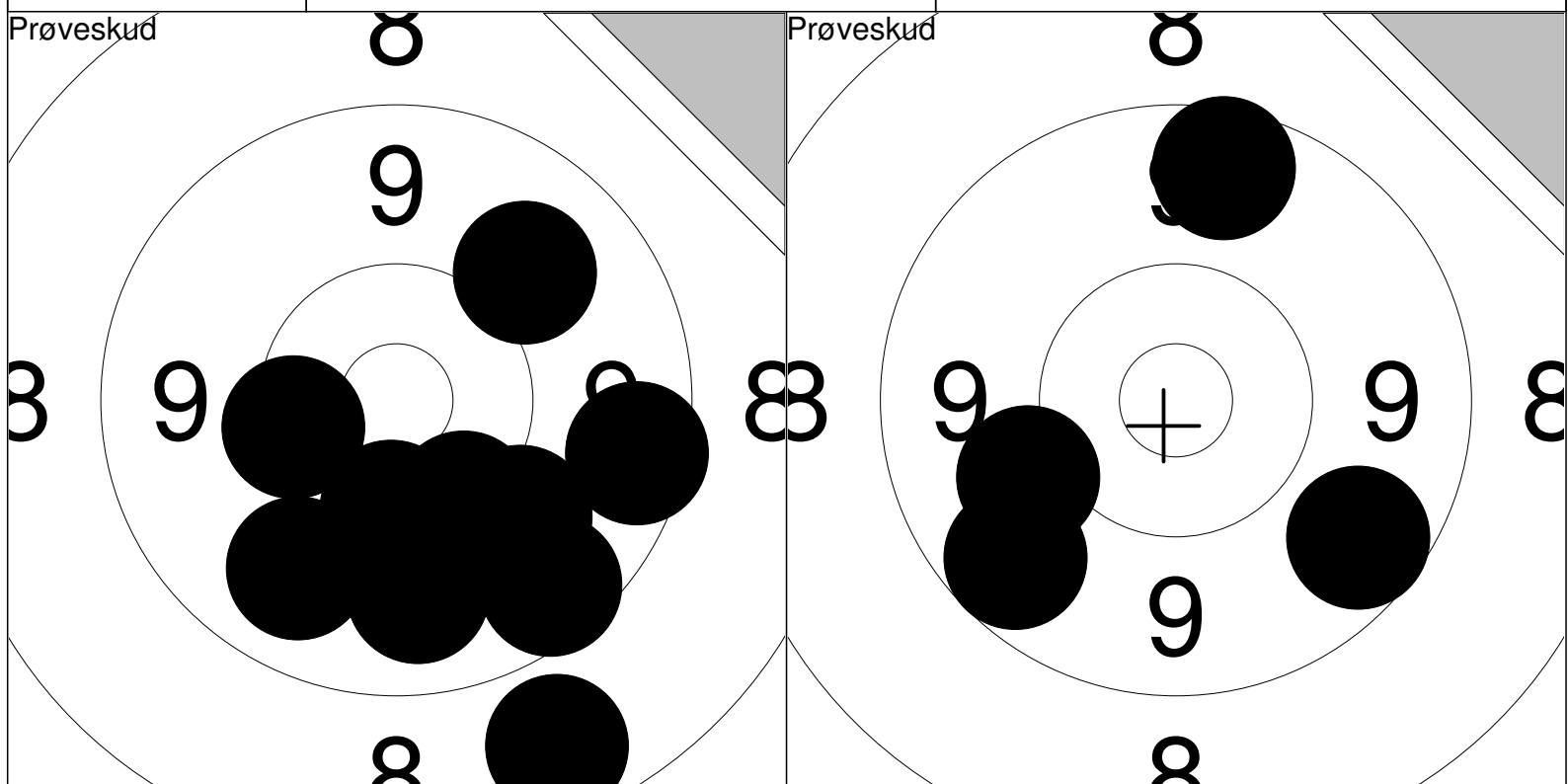

1: 10.3 ↓	6: 9.5 →	Serie 93.0	11: 9.6 ↙	Serie 37.0
2: 9.8 ↘	7: 8.6 ↘		12: 9.6 ↘	
3: 10.0 ↘	8: 9.8 ↘	Total 0.0	13: 9.5 ↑	Total 0.0
4: 9.9 ↗	9: 10.2 ↘		14: 10.0 ←	
5: 9.5 ↘	10: 10.3 ←			

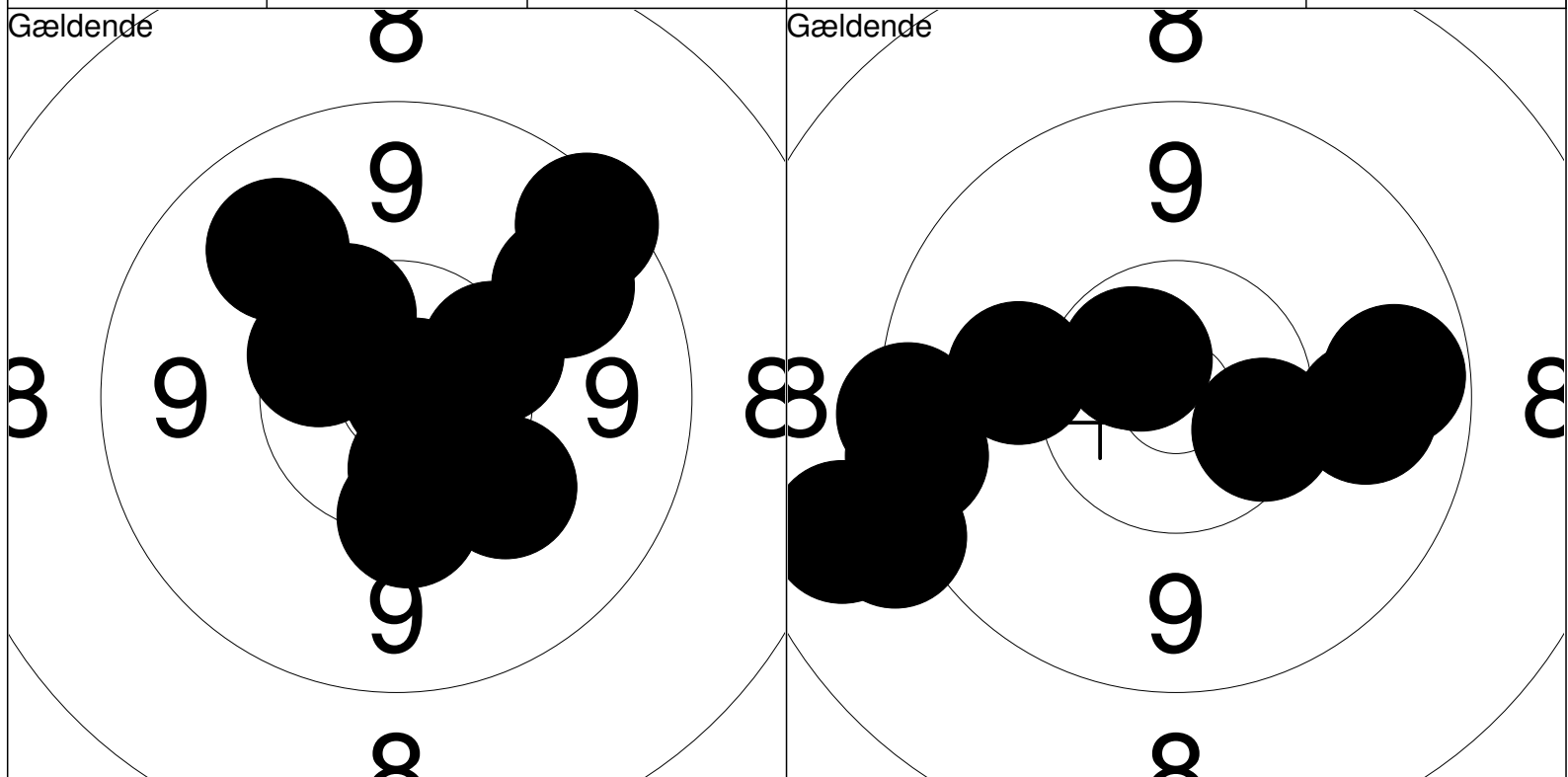

1: 10.3 ↓	6: 9.8 ↗	Serie 97.0	11: 9.7 →	16: *10.6 ↗	Serie 93.0
2: 9.8 ↗	7: 10.3 →		12: 10.0 ←	17: 9.8 →	
3: *10.4 ↖	8: 10.4 ↗	Total 97.0	13: 9.3 ←	18: 10.4 ↘	Total 190.0
4: 10.1 ↘	9: *10.8 →		14: 9.4 ←	19: 9.1 ←	
5: *10.5 ↓	10: 9.4 ↗		15: *10.7 ↗	20: 8.8 ←	

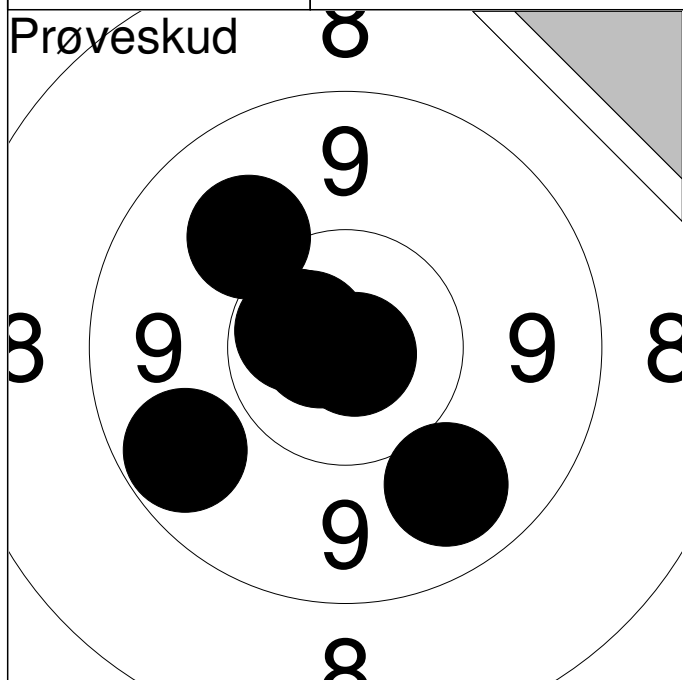

1:	*10.6					↖
2:	*10.7					↖
3:	9.8					↘
4:	10.0					↗
5:	9.6					↙
6:	*10.9					↘
7:	*10.8					↖
Serie						68.0
Total						0.0

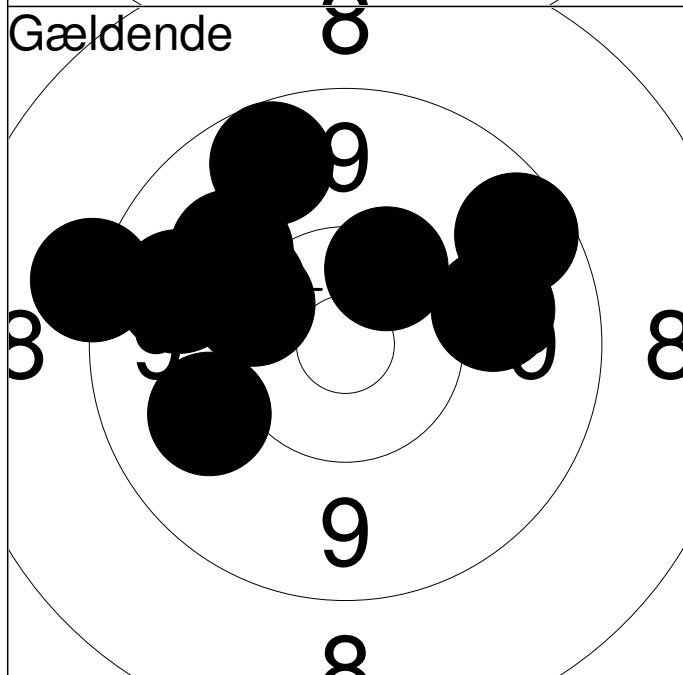

1:	9.9					↙
2:	9.8					↖
3:	10.3					↗
4:	9.6					↗
5:	10.0					↗
6:	10.4					↗
7:	10.2					↗
8:	9.1					↖
9:	9.6					↗
10:	9.9					→
Serie						94.0
Total						94.0

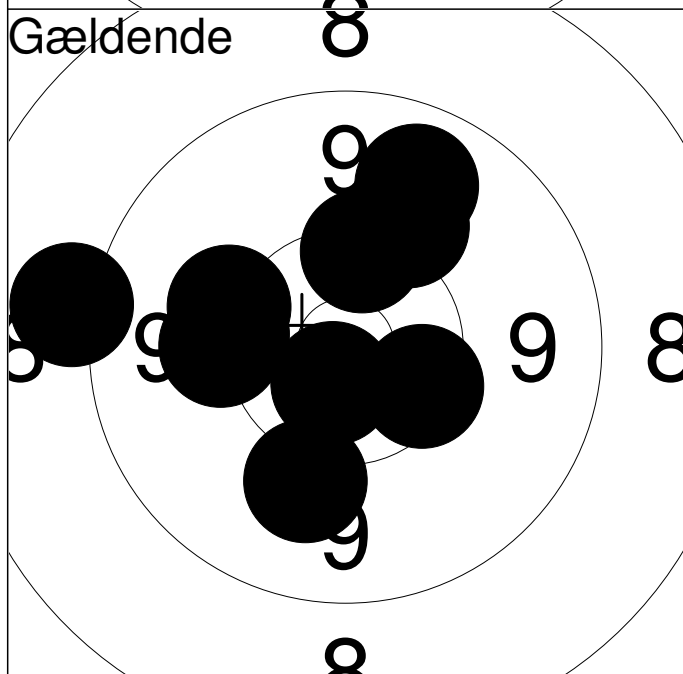

11:	10.2					↙
12:	9.0					↙
13:	*10.7					↘
14:	10.1					↙
15:	10.0					↘
16:	10.1					↖
17:	10.4					↘
18:	10.0					↗
19:	9.8					↗
20:	10.3					↖
Serie						98.0
Total						192.0

Prøveskud

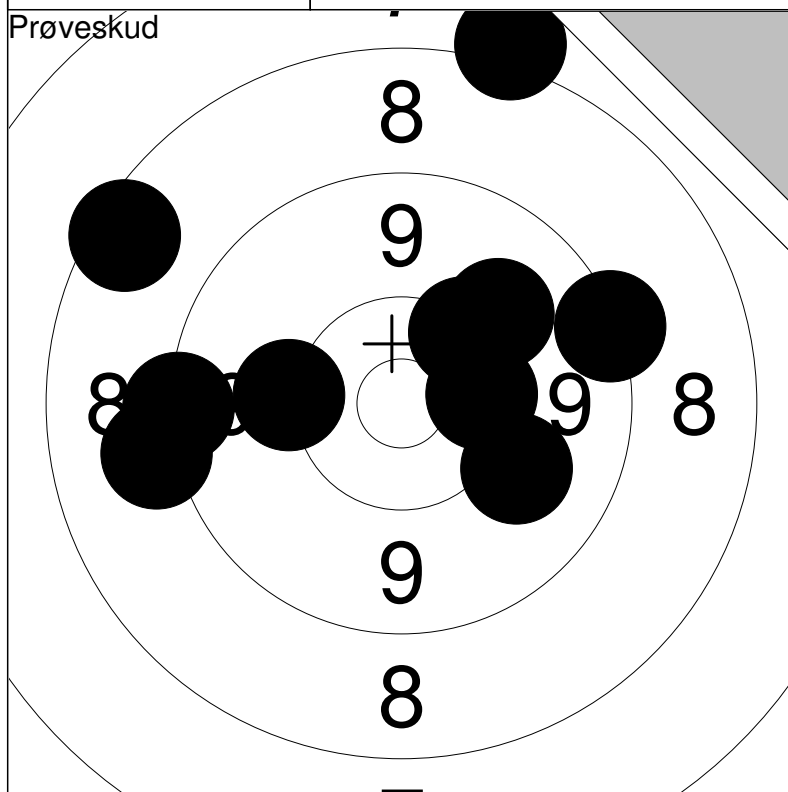

Prøveskud

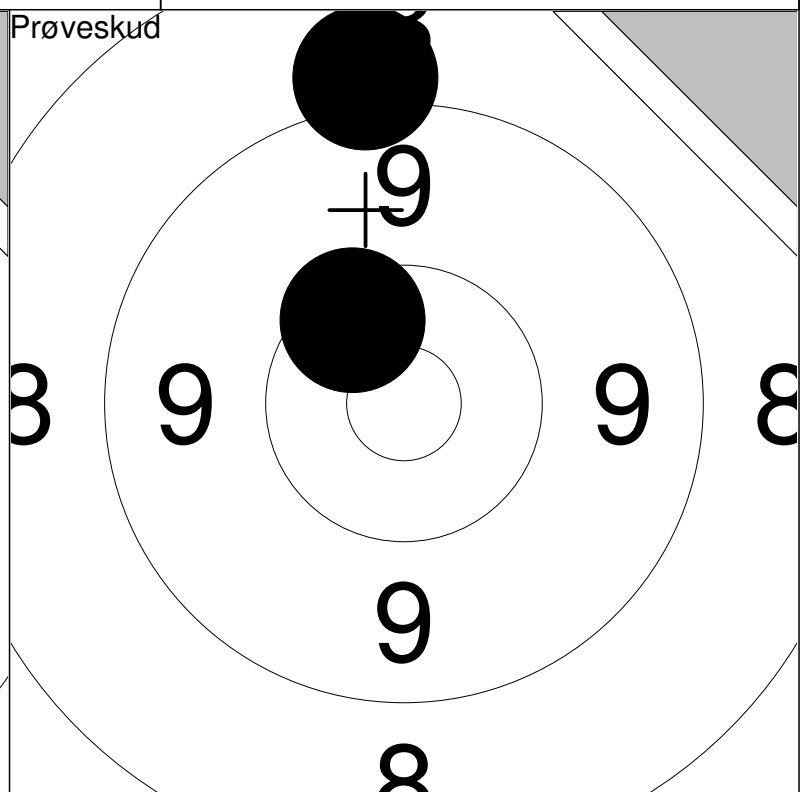

1:	8.4	↖
2:	9.0	←
3:	10.0	↗
4:	10.0	↘
5:	9.2	←

6:	10.2	↗
7:	10.3	→
8:	9.2	→
9:	10.1	←
10:	8.0	↑

Serie	93.0
Total	0.0

11:	9.0	↑
12:	10.4	↖

Serie	19.0
Total	0.0

Gældende

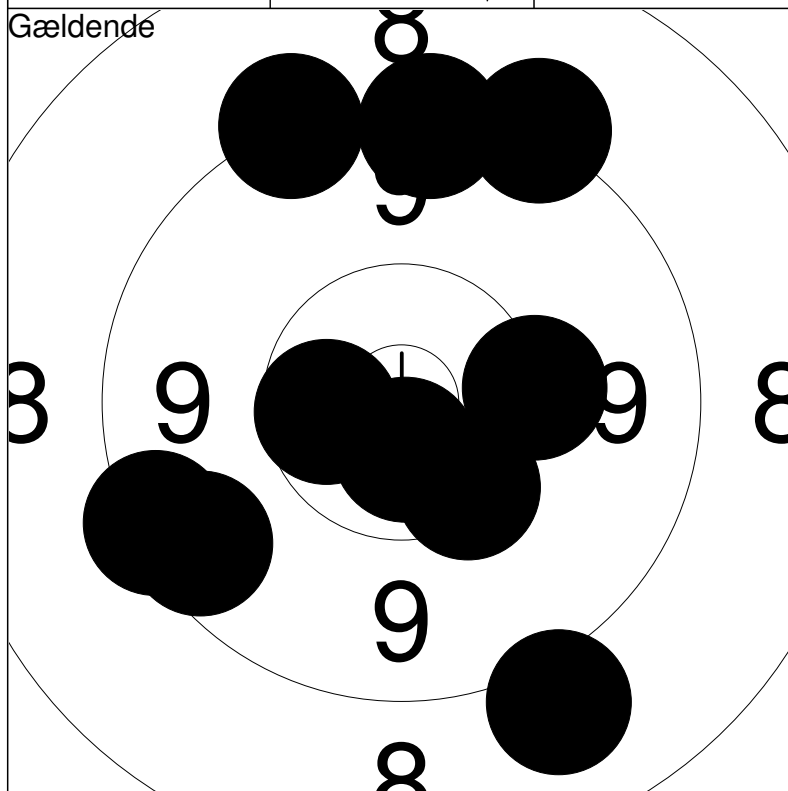

Gældende

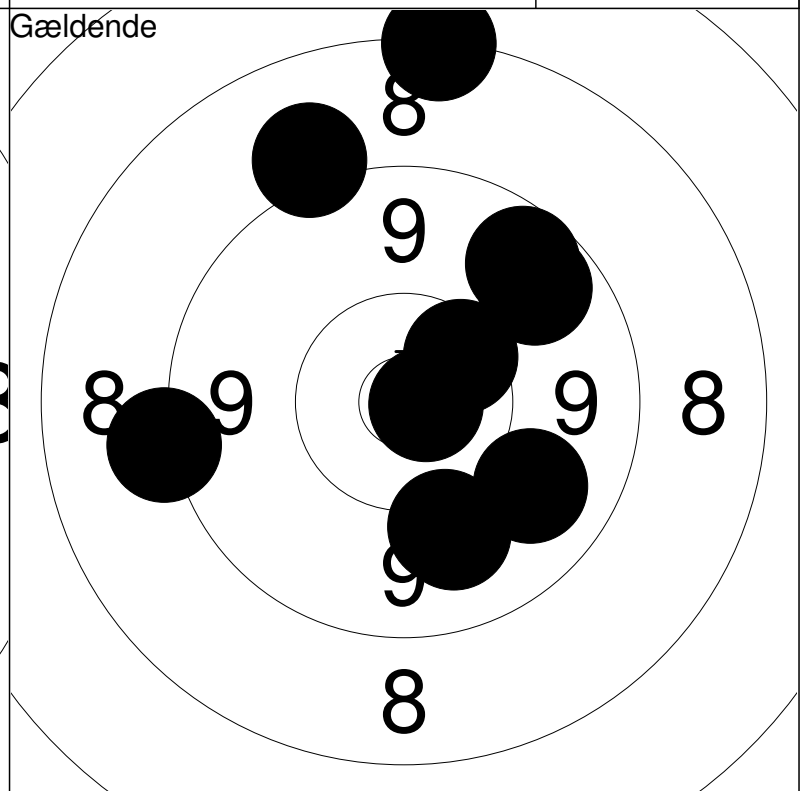

1:	9.3	↑
2:	8.9	↘
3:	9.2	↗
4:	*10.7	↘
5:	10.3	↘

6:	*10.5	←
7:	9.1	↗
8:	9.3	←
9:	9.5	←
10:	10.2	→

Serie	93.0
Total	93.0

11:	*10.8	→
12:	8.2	↑
13:	9.9	↘
14:	10.0	↘
15:	9.6	↗

16:	*10.4	↗
17:	9.7	↗
18:	9.8	↘
19:	9.1	←
20:	9.0	↑

Serie	92.0
Total	185.0

Vadum Skf.

BK1

Prøveskud

Prøveskud

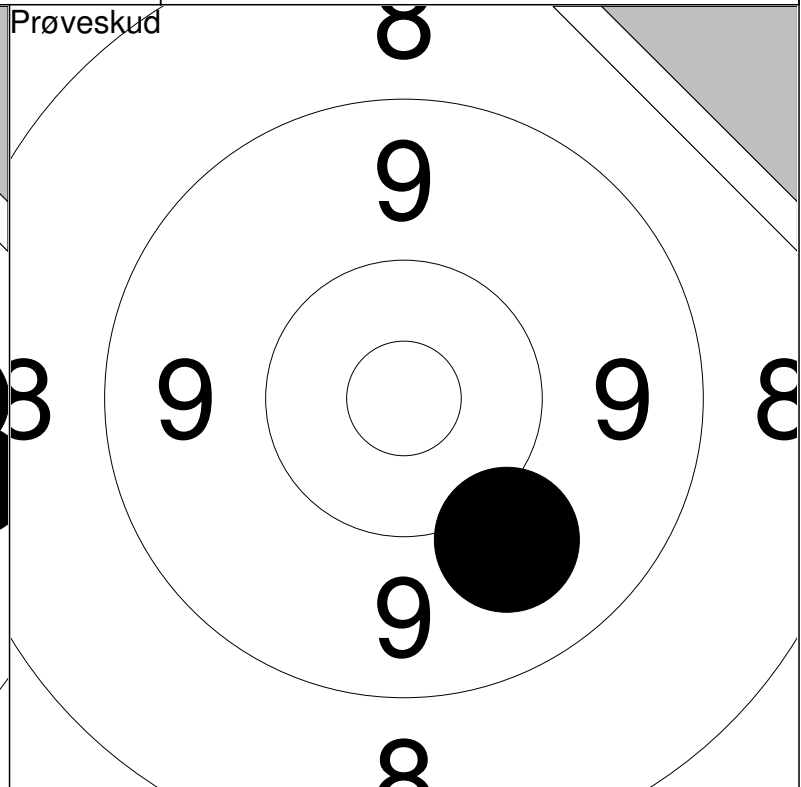
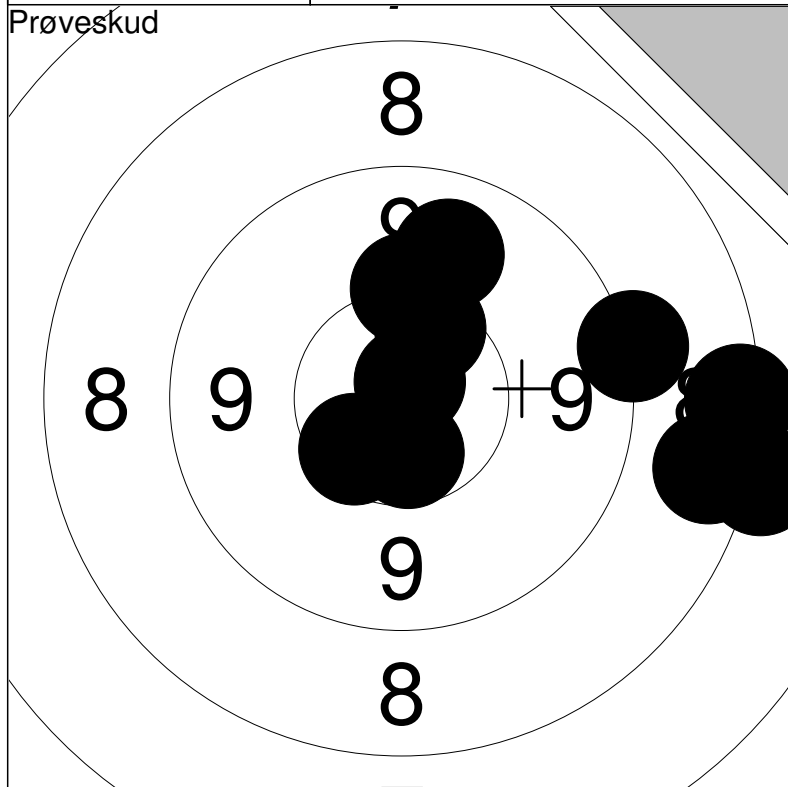

1: 8.5 →	6: *10.5 ↓	Serie	92.0
2: 8.3 →	7: 10.4 ↗		
3: 9.1 →	8: 10.1 ↑	Total	0.0
4: 8.1 →	9: 9.8 ↑		
5: *10.4 ↙	10: *10.8 ↗		

11: 9.9 ↘	Serie	9.0
	Total	0.0

Gældende

Gældende

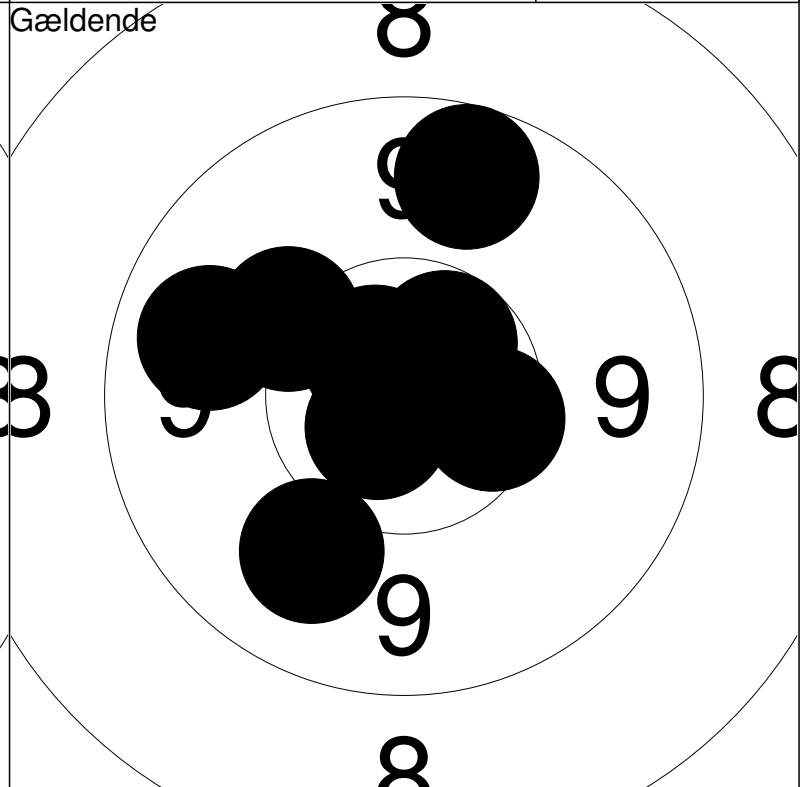
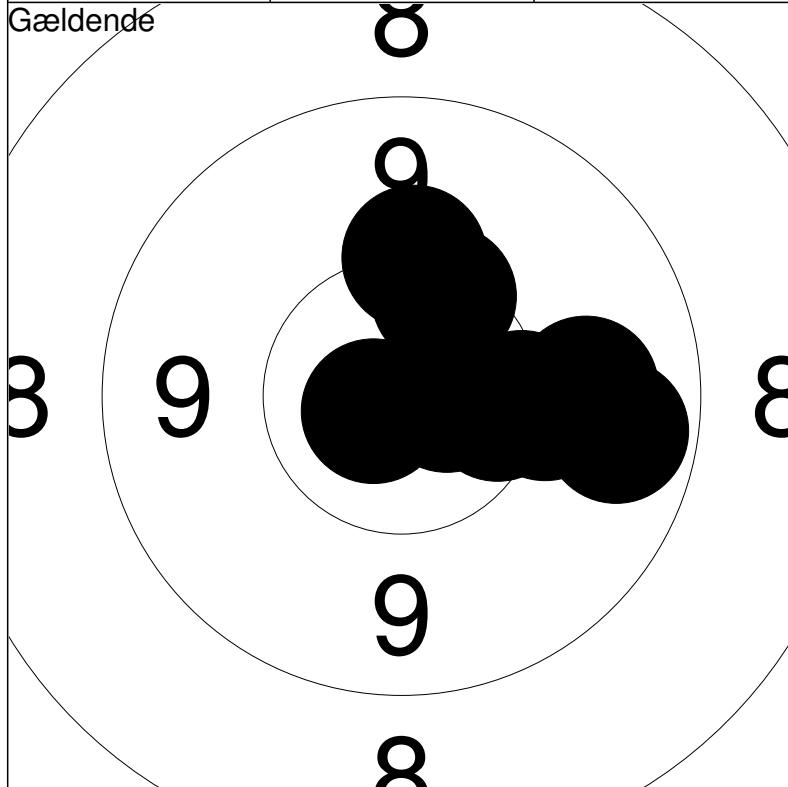

1: *10.7 →	6: 9.9 →	Serie	98.0
2: 10.1 →	7: 10.3 →		
3: *10.8 ↙	8: 10.4 →	Total	98.0
4: 10.3 ↗	9: 10.0 →		
5: 9.7 →	10: 10.2 ↑		

11: *10.4 →	16: *10.7 ↗	Serie	97.0
12: 9.9 ↘	17: 9.6 ↑		
13: 9.8 ↖	18: *10.8 ↗	Total	195.0
14: *10.7 ↙	19: 10.2 ↖		
15: *10.8 ↗	20: *10.6 ↗		

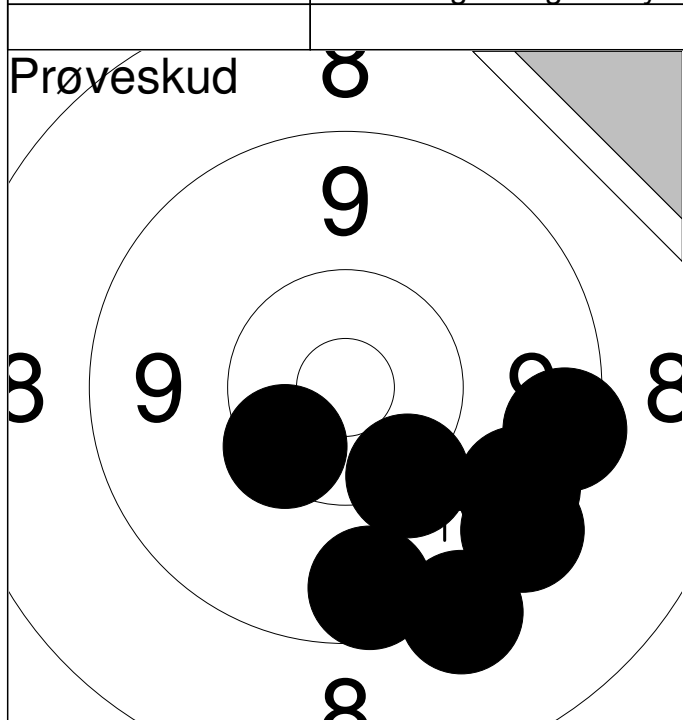

1:	9.4				↘
2:	9.6				↘
3:	9.2				↘
4:	9.6				↘
5:	10.2				↘
6:	9.4				→
7:	10.4				↙
Serie					65.0
Total					0.0

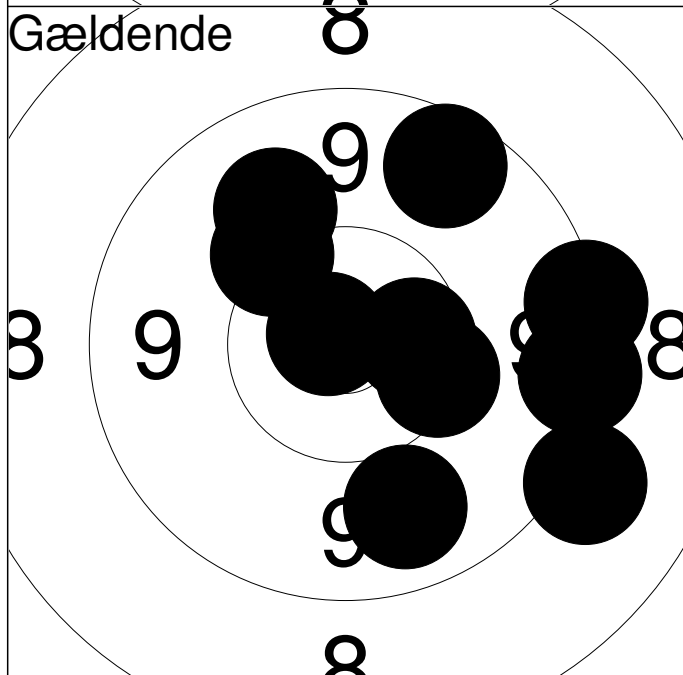

1:	*10.8				↗
2:	9.3				→
3:	9.8				↘
4:	9.9				↗
5:	*10.5				→
6:	10.3				↘
7:	10.2				↗
8:	9.0				↘
9:	9.5				↗
10:	9.3				→
Serie					94.0
Total					94.0

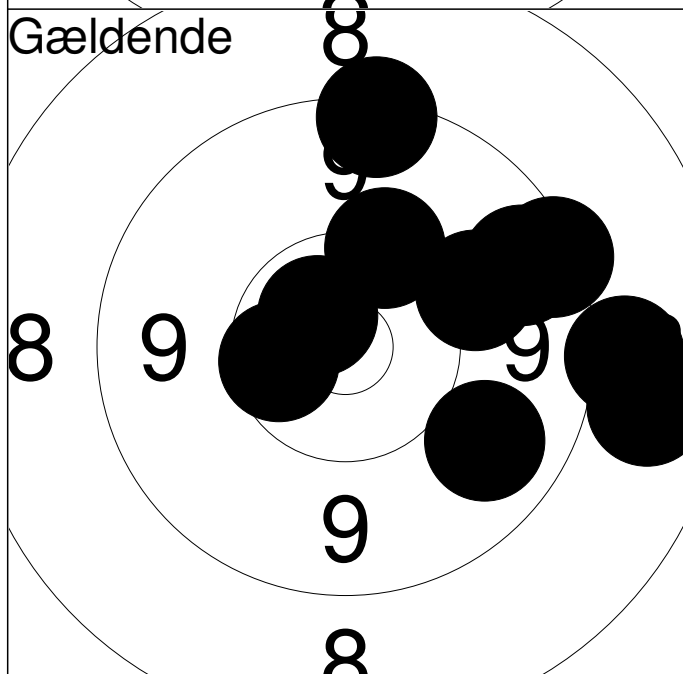

11:	9.3				↑
12:	9.8				↘
13:	8.7				→
14:	*10.5				←
15:	*10.7				↗
16:	10.2				↗
17:	9.3				→
18:	8.9				→
19:	9.6				↗
20:	10.0				→
Serie					92.0
Total					186.0

Prøveskud

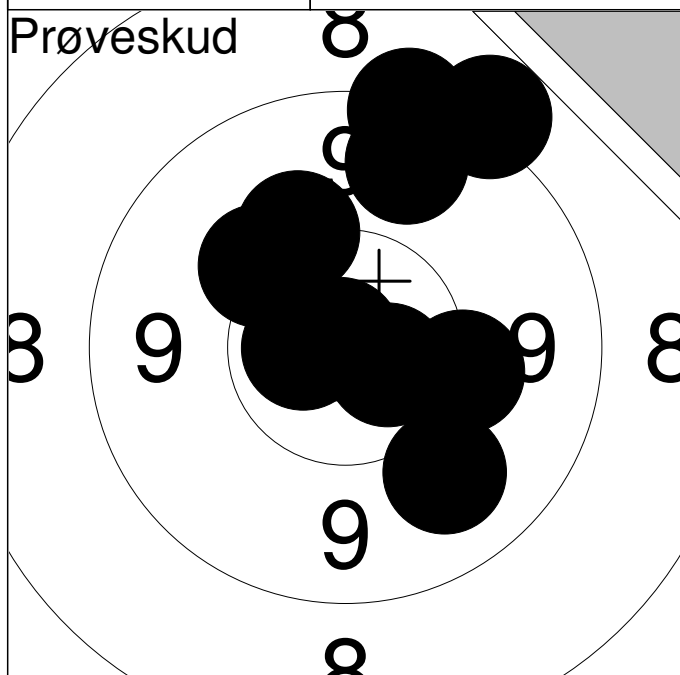

1:	*10.9	↗
2:	10.1	↗
3:	9.1	↗
4:	9.2	↗
5:	10.1	→
6:	*10.6	↘
7:	9.6	↗
8:	9.9	↘
9:	10.2	↗
10:	*10.7	←

Serie	96.0
-------	------

Total	0.0
-------	-----

Gældende

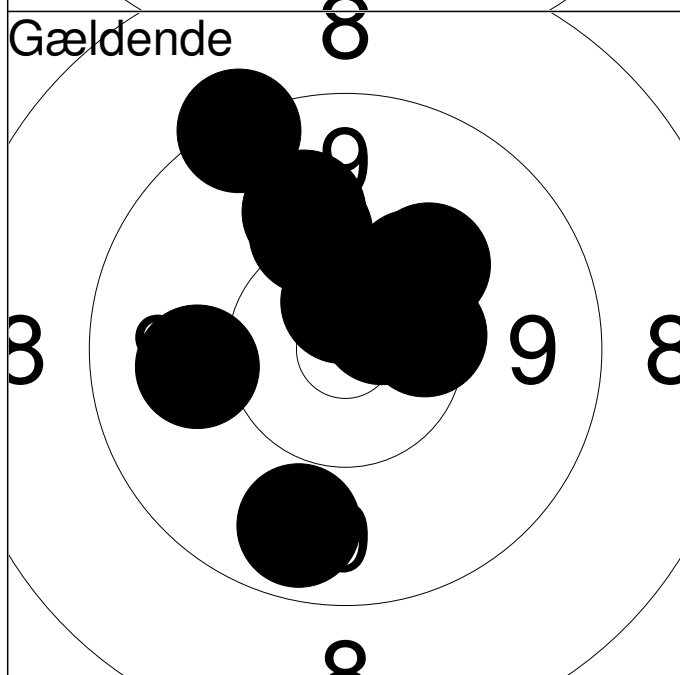

1:	10.4	→
2:	10.2	↗
3:	10.3	↗
4:	9.3	↗
5:	10.1	↗
6:	10.0	↗
7:	*10.6	↗
8:	9.7	↘
9:	10.0	←
10:	*10.6	↗

Serie	98.0
-------	------

Total	98.0
-------	------

Gældende

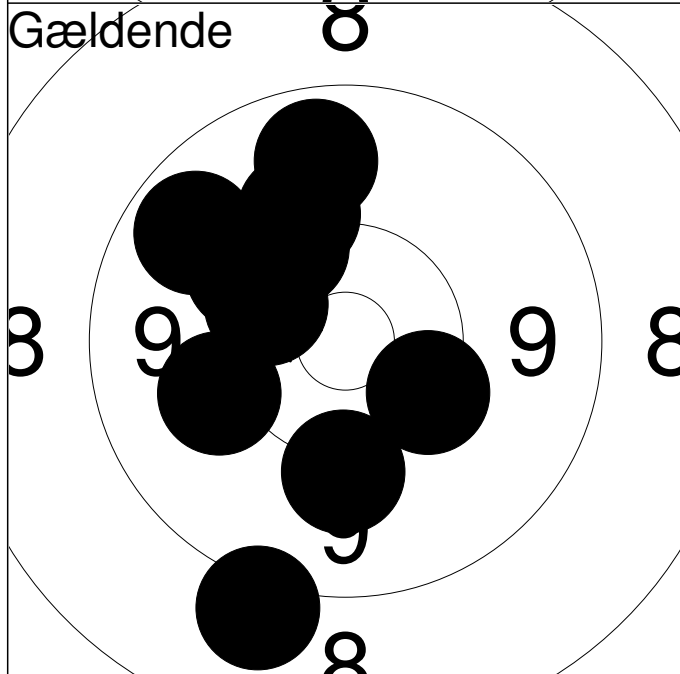

11:	10.1	↗
12:	9.7	↗
13:	10.0	↗
14:	10.0	←
15:	10.1	↘
16:	9.7	↗
17:	9.0	↘
18:	10.2	↗
19:	10.4	↗
20:	10.3	↘

Serie	97.0
-------	------

Total	195.0
-------	-------

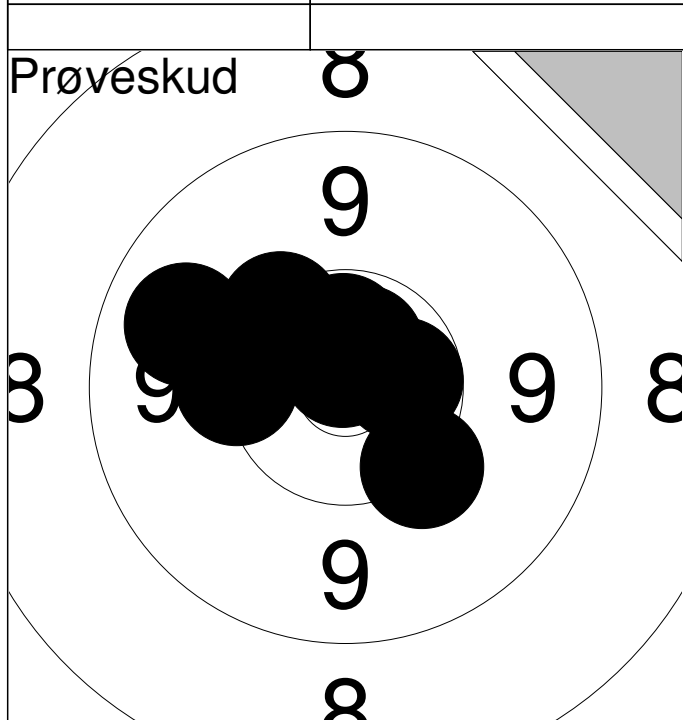

1:	*10.8		↑
2:	10.2		←
3:	9.8		↗
4:	10.3		↘
5:	10.2		↙
6:	*10.6		↑
7:	*10.7		↗
8:	*10.6		→
Serie			79.0
Total			0.0

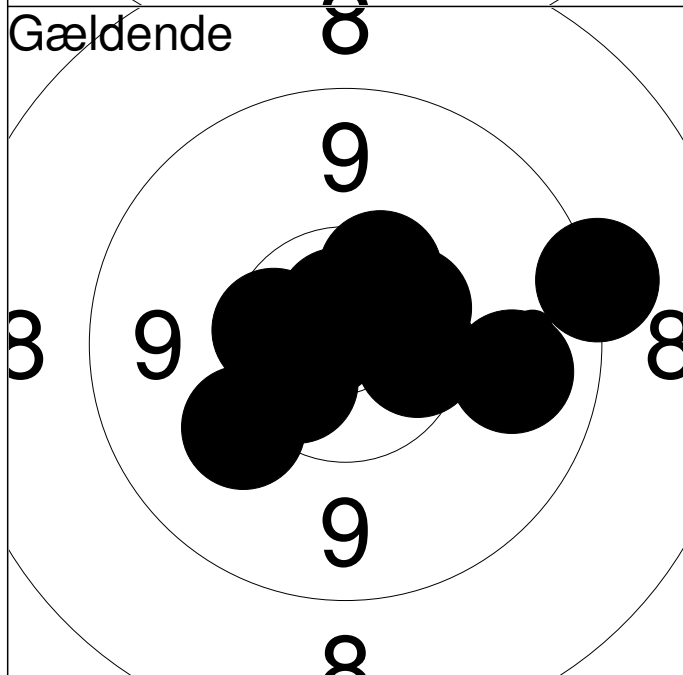

1:	9.2		→
2:	*10.7		↑
3:	*10.5		↙
4:	*10.5		↘
5:	*10.8		↗
6:	*10.5		←
7:	*10.4		↖
8:	*10.5		→
9:	9.8		→
10:	10.1		↙
Serie			98.0
Total			98.0

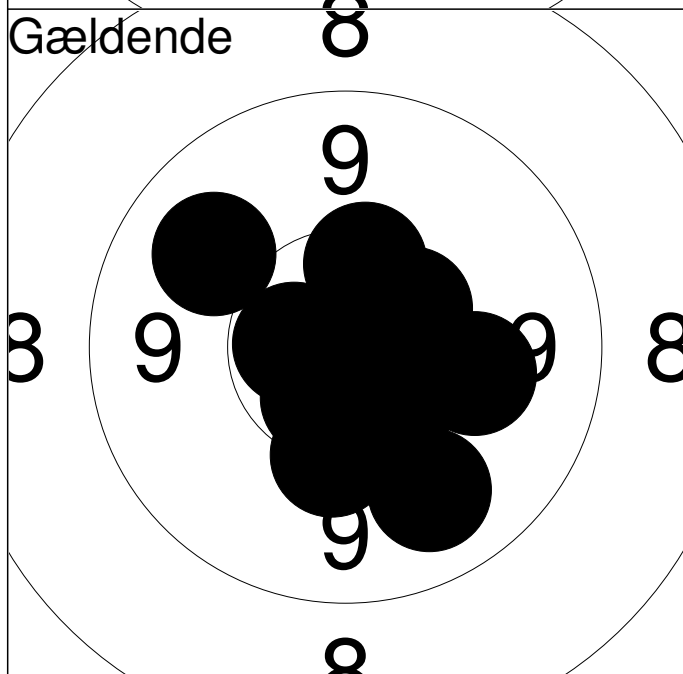

11:	*10.8		←
12:	*10.5		↙
13:	10.1		→
14:	9.9		↗
15:	*10.6		↘
16:	9.8		↙
17:	*10.6		←
18:	*10.4		↗
19:	10.4		↑
20:	10.2		↓
Serie			98.0
Total			196.0

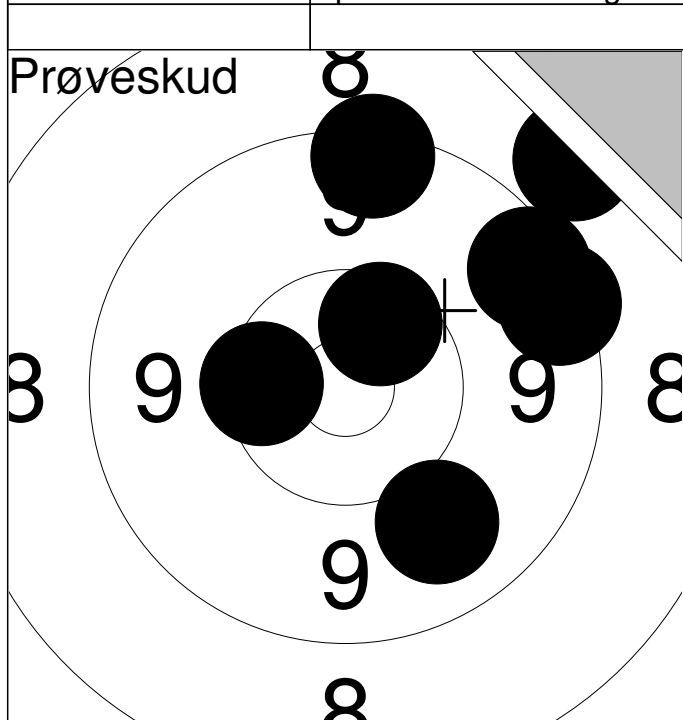

1:	8.7	↗
2:	9.4	↗
3:	9.4	→
4:	9.9	↘
5:	*10.5	↗
6:	9.3	↑
7:	10.4	←
Serie		64.0
Total		0.0

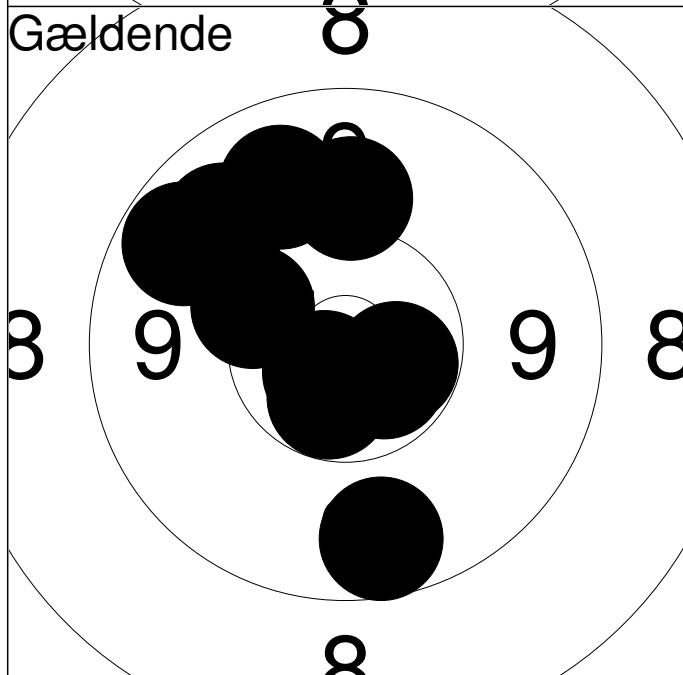

1:	9.8	↗
2:	9.6	↘
3:	9.8	↗
4:	10.0	↑
5:	*10.6	↘
6:	9.6	↗
7:	*10.6	↘
8:	10.3	↗
9:	*10.6	↘
10:	*10.7	↘
Serie		96.0
Total		96.0

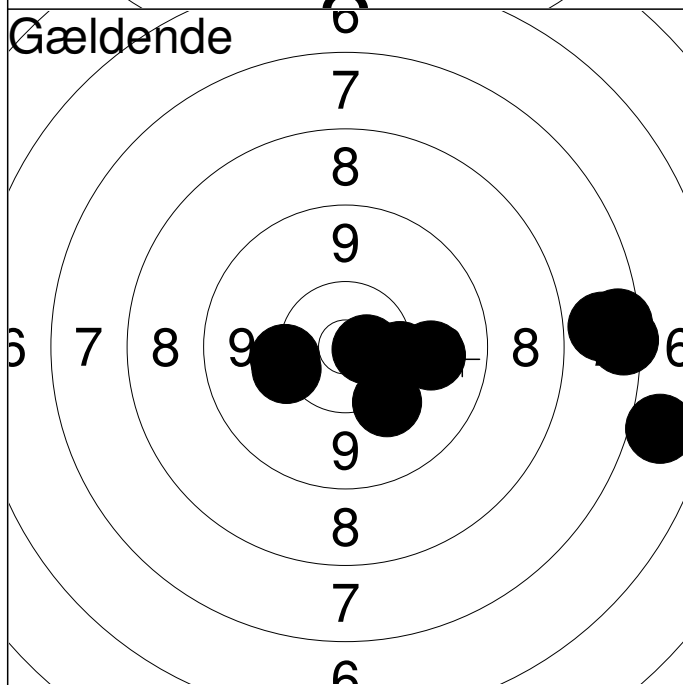

11:	9.9	→
12:	7.4	→
13:	6.8	→
14:	7.5	→
15:	7.7	→
16:	10.3	→
17:	10.2	←
18:	*10.7	→
19:	10.2	←
20:	10.1	↘
Serie		86.0
Total		182.0

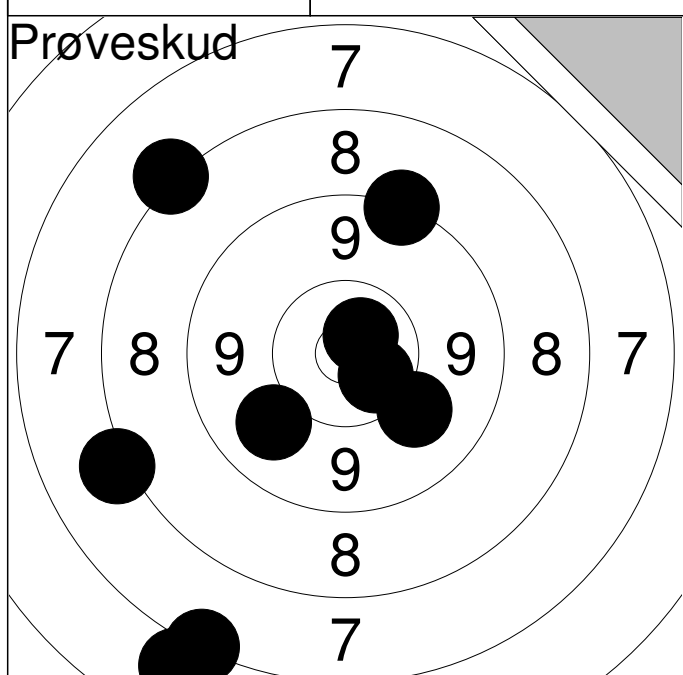

1:	8.1	↗
2:	9.9	↙
3:	10.0	↘
4:	9.2	↗
5:	*10.7	↗
6:	7.2	↙
7:	6.9	↙
8:	8.1	↙
9:	*10.5	↘
Serie		77.0
Total		0.0

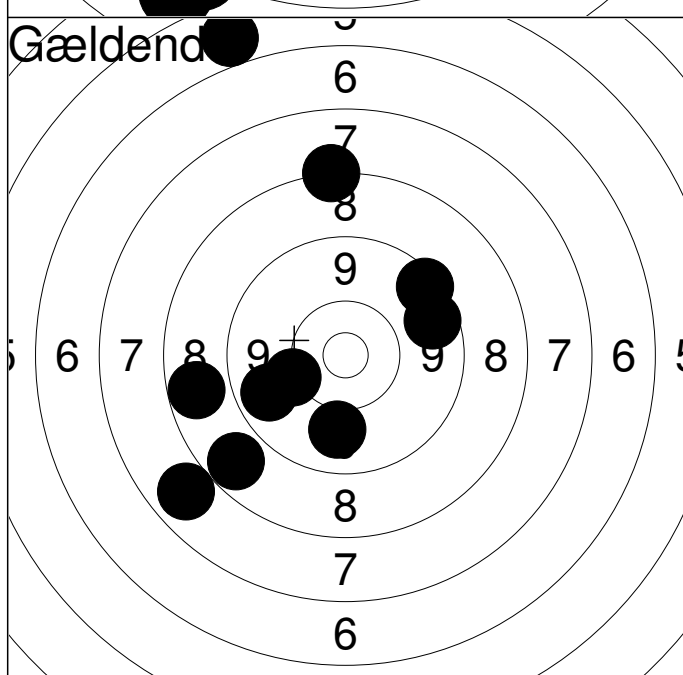

1:	9.9	↓
2:	8.6	↙
3:	7.7	↙
4:	8.2	↑
5:	5.7	↑
6:	8.6	←
7:	9.4	↗
8:	9.7	↙
9:	9.6	→
10:	10.1	←
Serie		82.0
Total		82.0

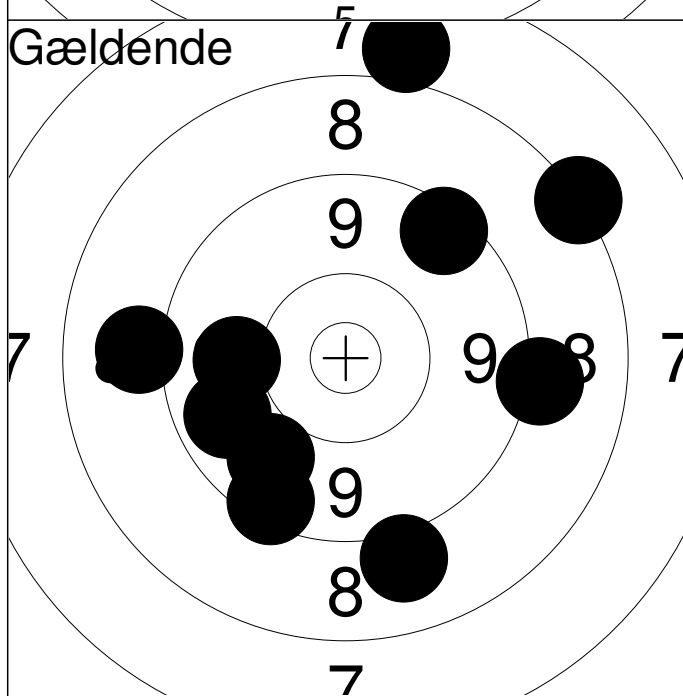

11:	9.9	←
12:	9.8	↙
13:	8.9	↓
14:	9.4	↙
15:	9.7	↙
16:	7.8	↑
17:	8.9	←
18:	9.4	↗
19:	9.1	→
20:	8.2	↗
Serie		85.0
Total		167.0

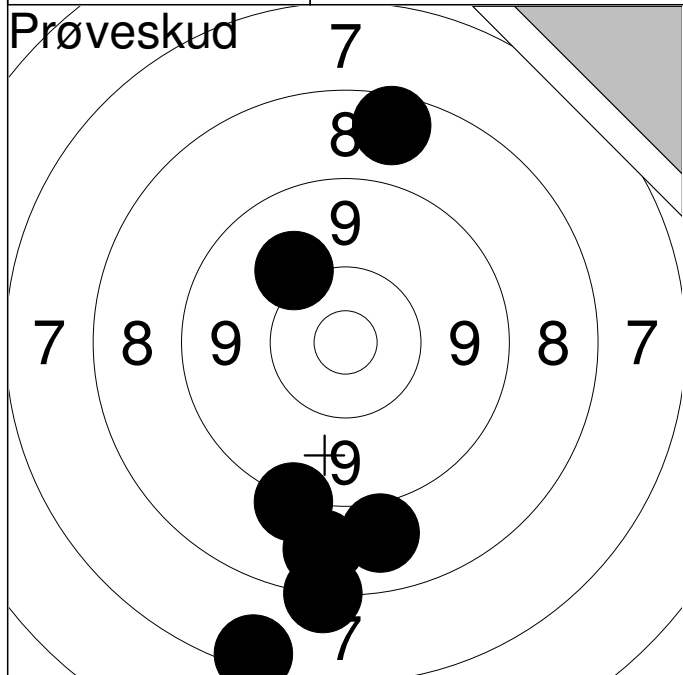

1:	8.5	↑
2:	8.2	↓
3:	9.1	↓
4:	8.7	↓
5:	7.4	↓
6:	8.8	↓
7:	10.0	↗
Serie		58.0
Total		0.0

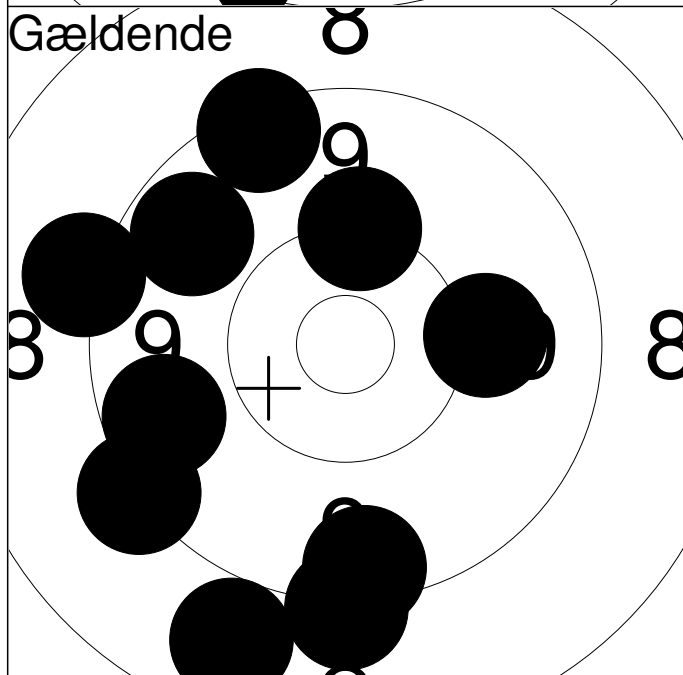

1:	9.4	↑
2:	9.1	↓
3:	10.2	↑
4:	9.7	↗
5:	10.0	→
6:	9.1	←
7:	9.4	↓
8:	9.6	←
9:	9.2	↙
10:	8.7	↓
Serie		91.0
Total		91.0

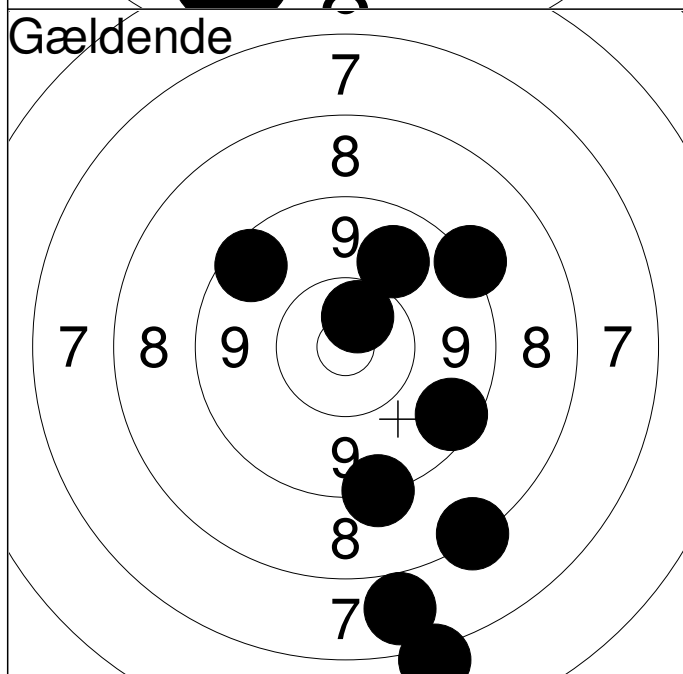

11:	8.2	↓
12:	7.7	↓
13:	9.5	↗
14:	7.0	↓
15:	9.8	↑
16:	9.5	↘
17:	*10.6	↑
18:	9.2	↓
19:	9.2	↗
Serie		77.0
Total		168.0

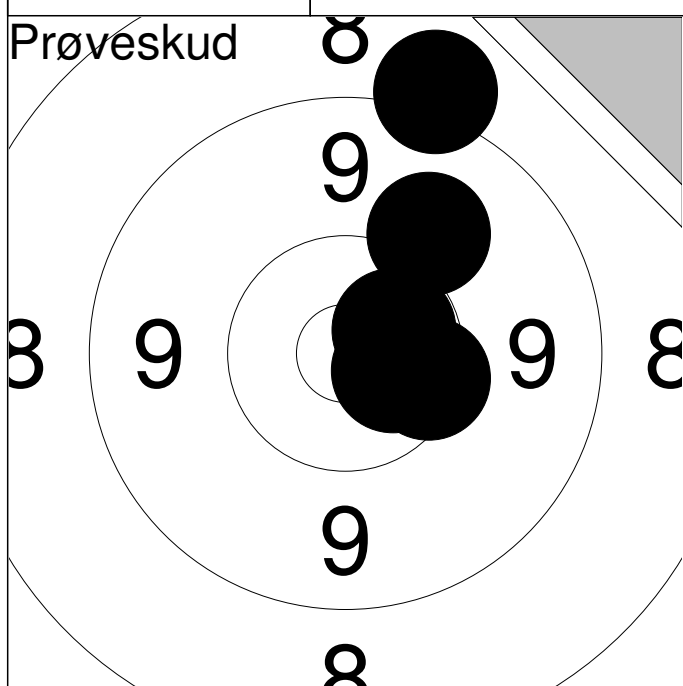

1:	9.0	↗
2:	10.0	↗
3:	*10.6	→
4:	10.4	→
5:	*10.6	↗
Serie		49.0
Total		0.0

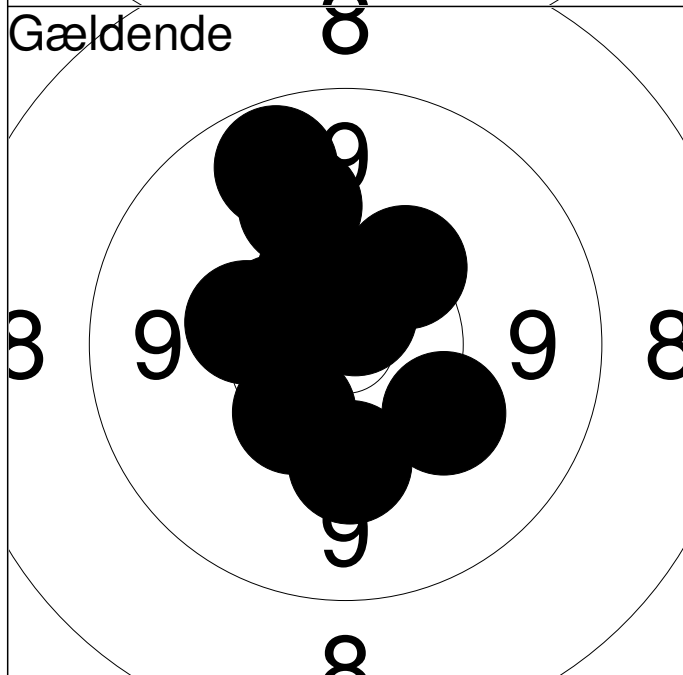

1:	10.3	↖
2:	*10.5	↗
3:	10.3	↗
4:	10.1	↘
5:	*10.7	↗
6:	*10.5	↗
7:	9.7	↗
8:	10.0	↗
9:	10.2	↘
10:	10.4	↘
Serie		99.0
Total		99.0

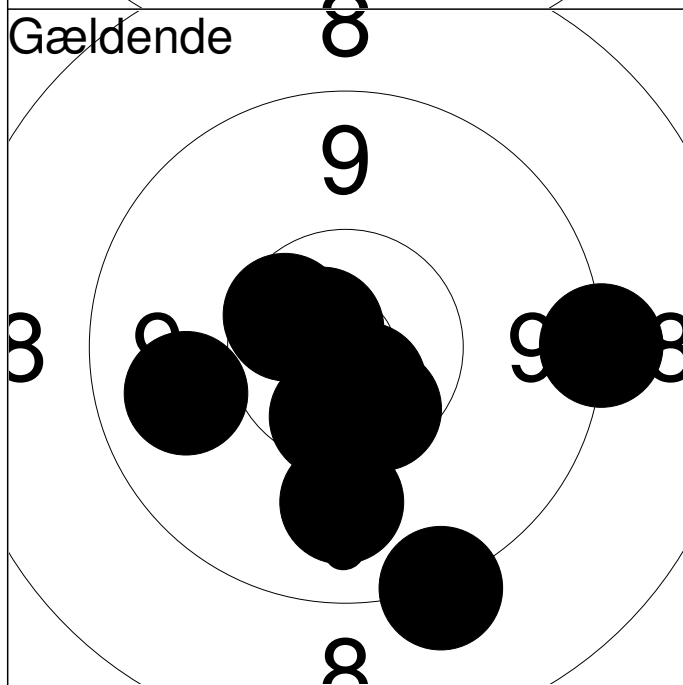

11:	*10.8	↗
12:	*10.5	↗
13:	9.8	↖
14:	*10.5	↗
15:	9.2	→
16:	*10.7	↘
17:	9.2	↘
18:	*10.5	↘
19:	*10.5	↘
20:	9.9	↘
Serie		96.0
Total		195.0

Prøveskud

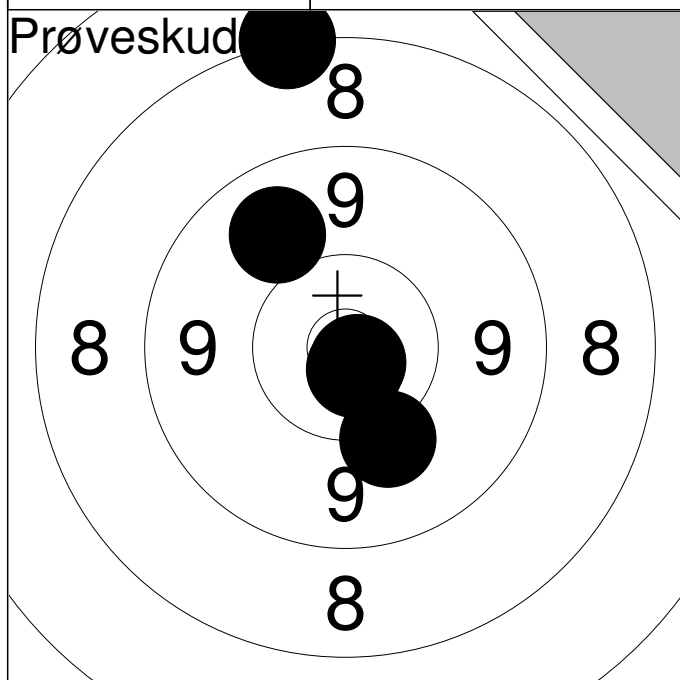

1:	8.2	↕
2:	9.8	↗
3:	*10.7	↘
4:	10.1	↘
5:	*10.8	↘

Serie	47.0
Total	0.0

Gældende

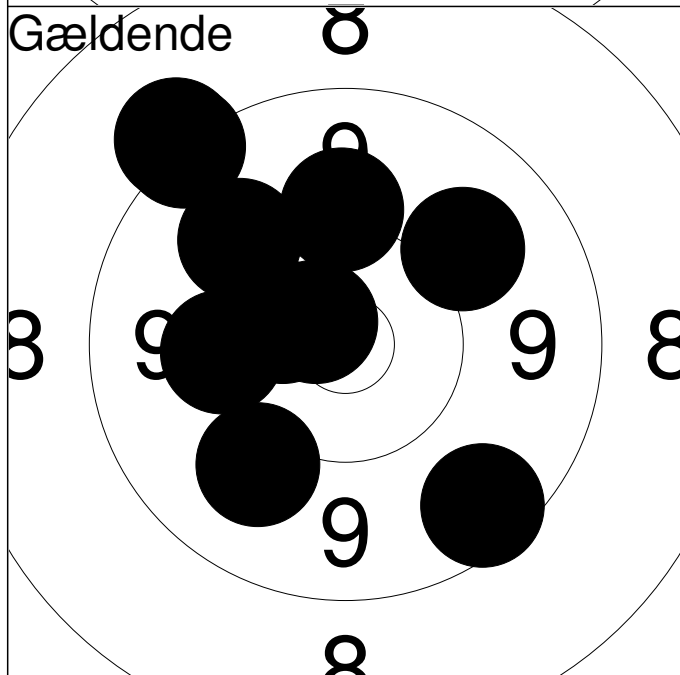

1:	10.0	↗
2:	*10.5	↗
3:	9.2	↗
4:	9.1	↗
5:	10.0	↕
6:	10.1	↖
7:	9.5	↘
8:	10.0	↘
9:	9.9	↗
10:	*10.7	↗

Serie	96.0
Total	96.0

Gældende

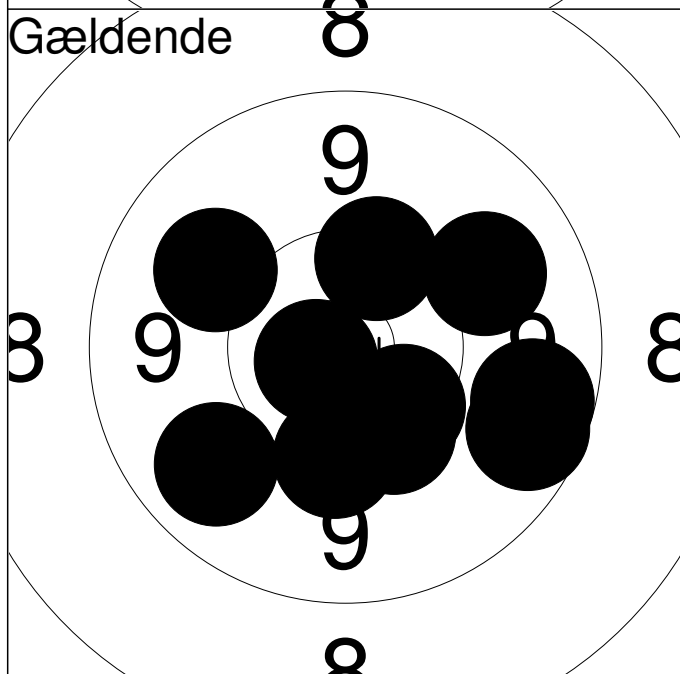

11:	9.6	↘
12:	10.4	↘
13:	9.8	↘
14:	*10.7	↖
15:	10.3	↘
16:	9.9	↗
17:	9.6	↘
18:	9.9	↗
19:	10.2	↘
20:	10.3	↗

Serie	95.0
Total	191.0

Vadum Skf.

BK3

Prøveskud

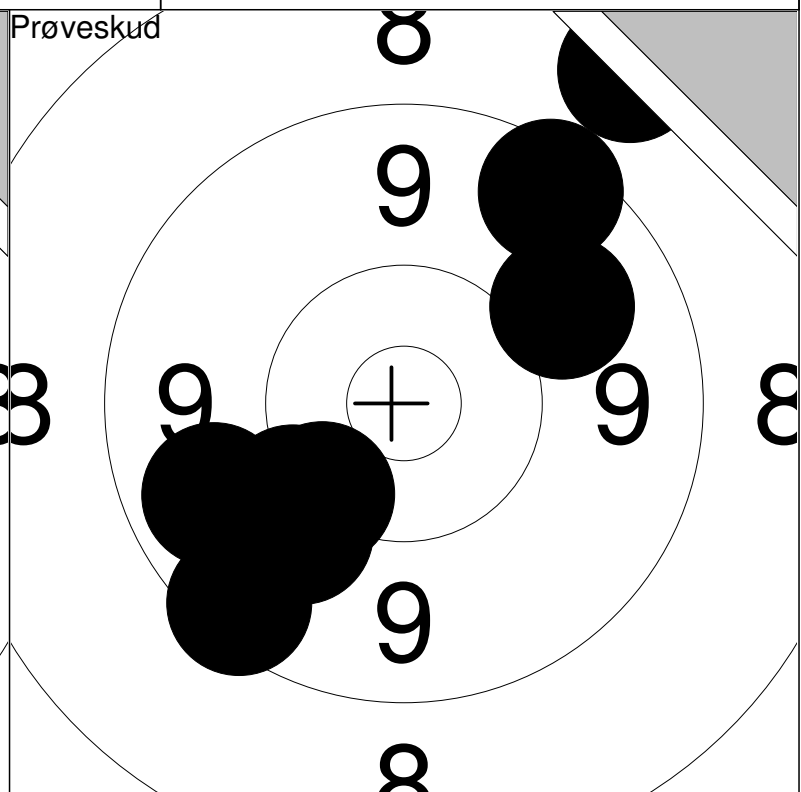
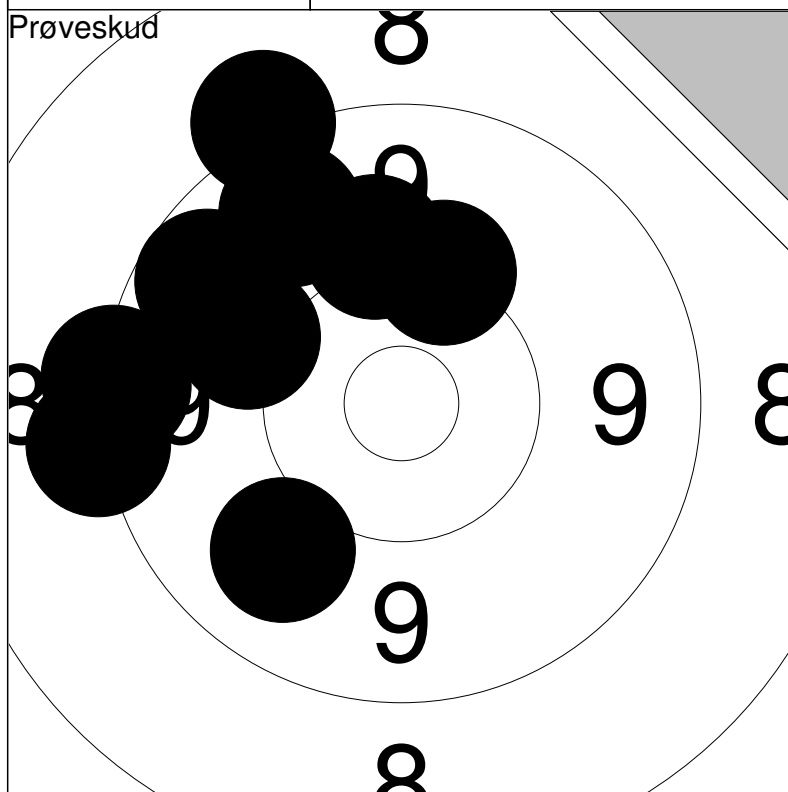

1: 10.2 ↗	6: 9.3 ←		11: 10.2 ↘	16: 8.5 ↗	
2: 10.0 ↖	7: 10.0 ↗	Serie	12: 10.0 ↘	17: 9.9 ↗	Serie
3: 9.2 ←	8: 9.9 ↘	93.0	13: 9.7 ←	18: 9.4 ↘	74.0
4: 9.6 ↗	9: 9.1 ←	Total	14: 10.1 ↘		0.0
5: 9.1 ↗	10: 9.7 ↗	0.0	15: 9.4 ↗		0.0

Gældende

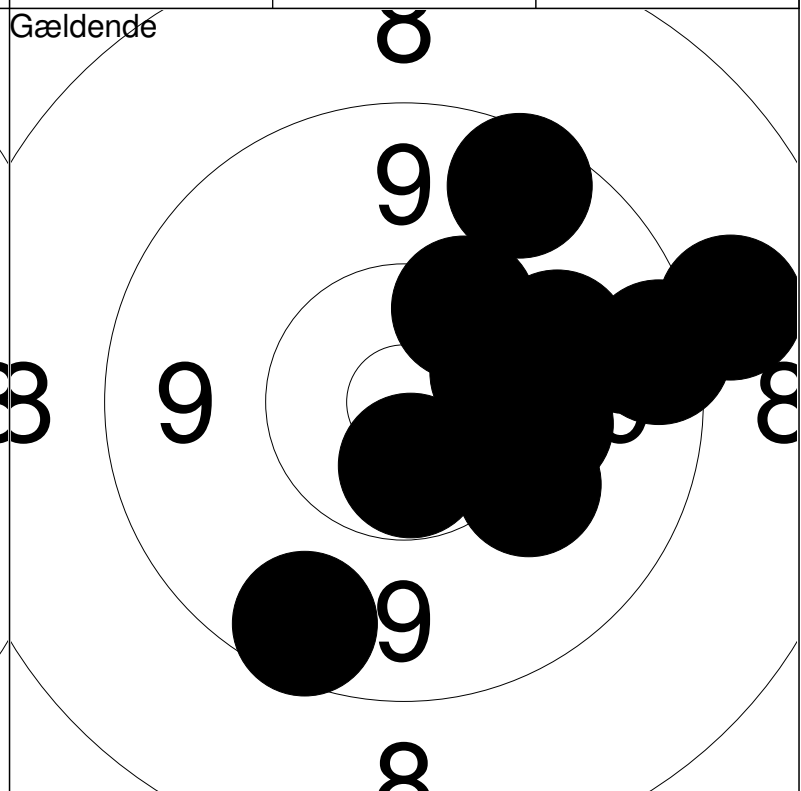
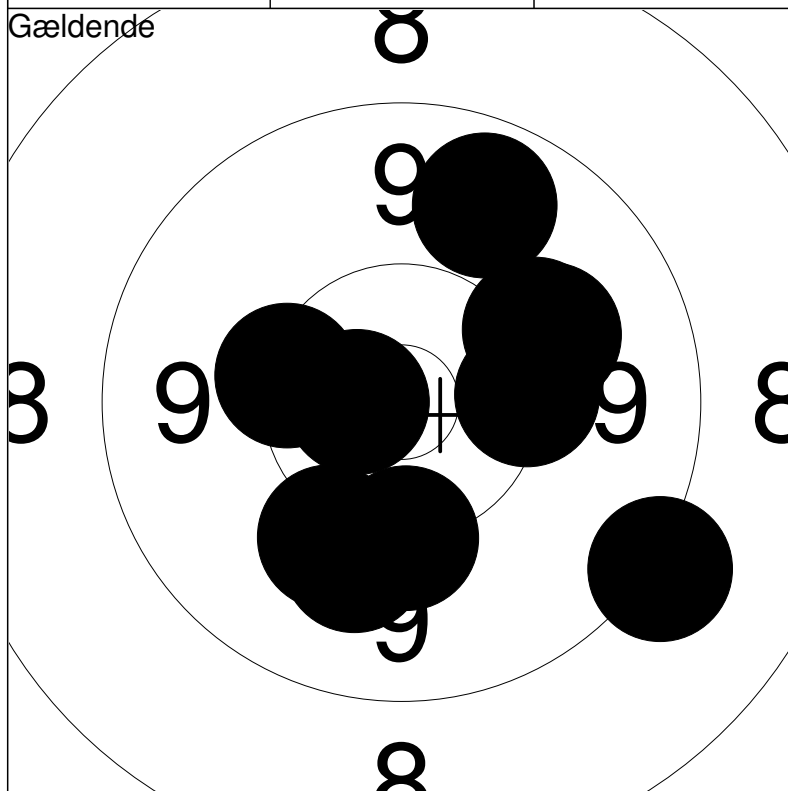

1: 10.2 →	6: 10.1 ↗		11: *10.6 ↓	16: 9.5 ↘	
2: 10.0 →	7: 10.0 ↓	Serie	12: 10.2 →	17: 10.4 →	Serie
3: 9.1 ↘	8: 10.2 ↓	98.0	13: 10.1 ↘	18: 10.0 →	95.0
4: 10.3 ←	9: *10.7 ←	Total	14: 10.3 ↗	19: 9.5 ↗	193.0
5: 9.7 ↗	10: 10.1 ↘	98.0	15: 9.4 →	20: 8.9 →	0.0

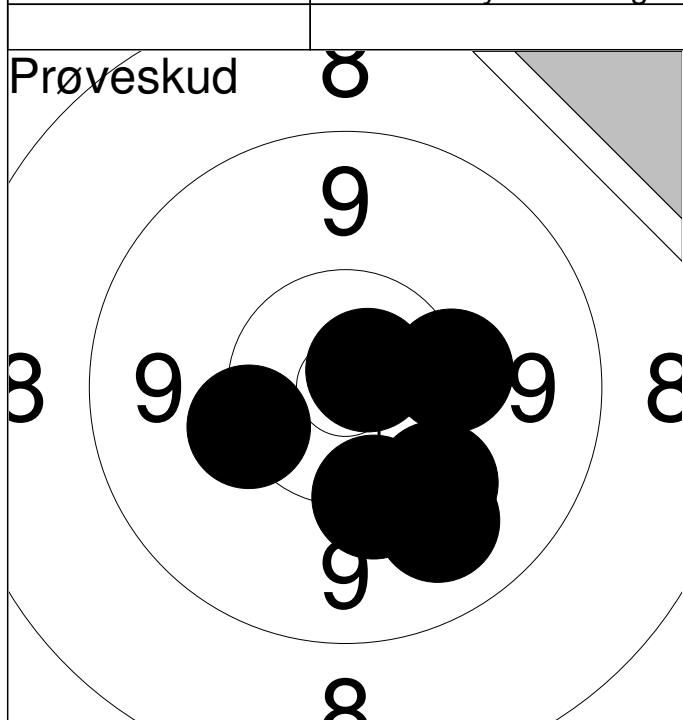

1:	10.2	→
2:	10.1	↘
3:	9.9	↘
4:	10.2	↘
5:	10.2	←
6:	*10.8	↗
Serie		59.0
Total		0.0

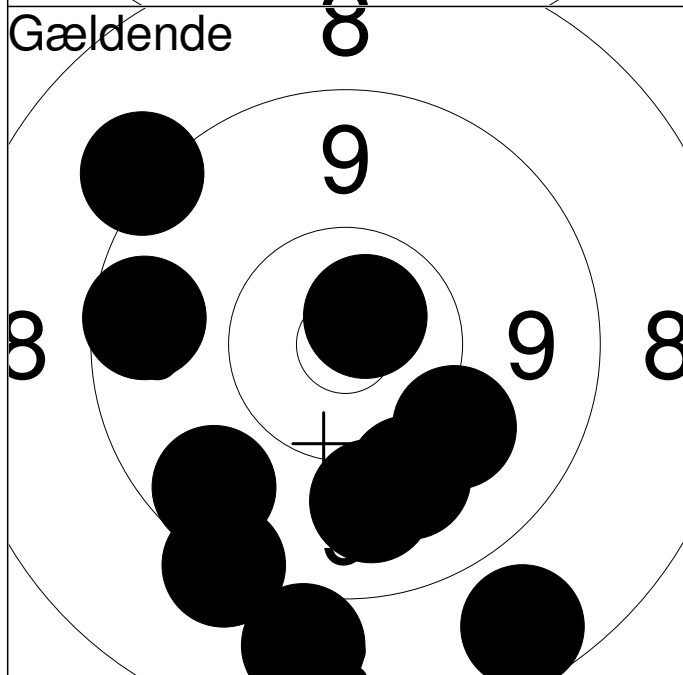

1:	8.8	↓
2:	9.6	↙
3:	8.6	↘
4:	9.5	←
5:	9.2	↙
6:	10.0	↘
7:	9.9	↘
8:	*10.7	↗
9:	9.1	↗
10:	10.0	↘
Serie		91.0
Total		91.0

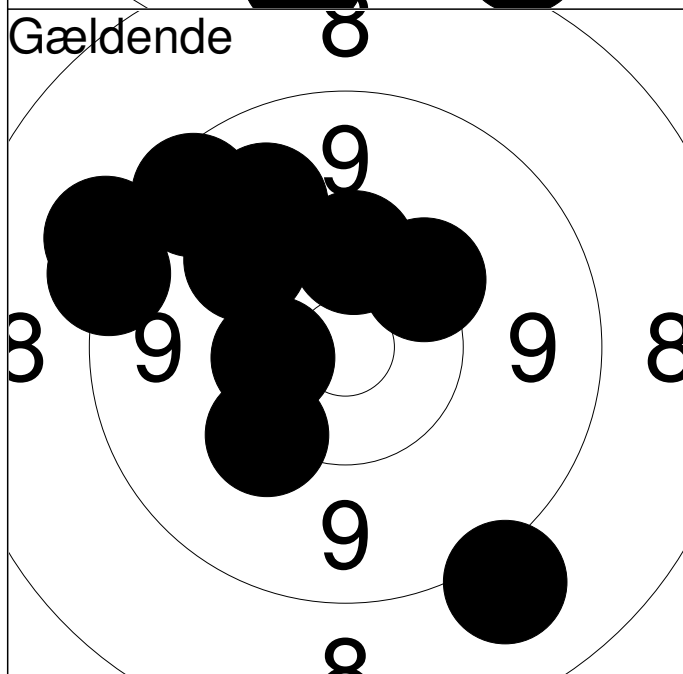

11:	9.0	↘
12:	*10.5	←
13:	10.1	↗
14:	10.2	↙
15:	9.5	↗
16:	9.9	↗
17:	9.1	↗
18:	9.2	↗
19:	10.3	↑
20:	10.3	↗
Serie		95.0
Total		186.0

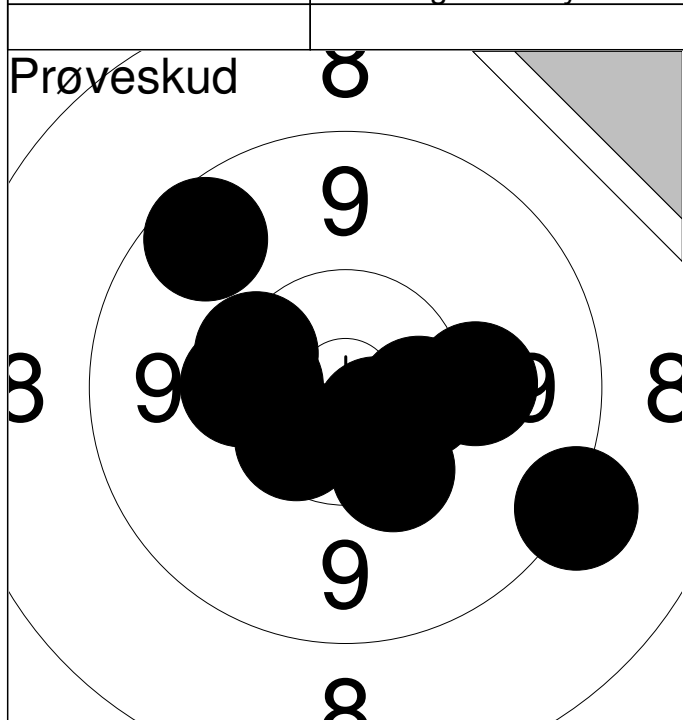

1:	10.3	←
2:	10.4	←
3:	10.3	↗
4:	*10.5	↙
5:	*10.5	→
6:	9.1	↘
7:	9.6	↗
8:	*10.7	↘
9:	10.3	↘
10:	10.1	→
Serie		98.0
Total		0.0

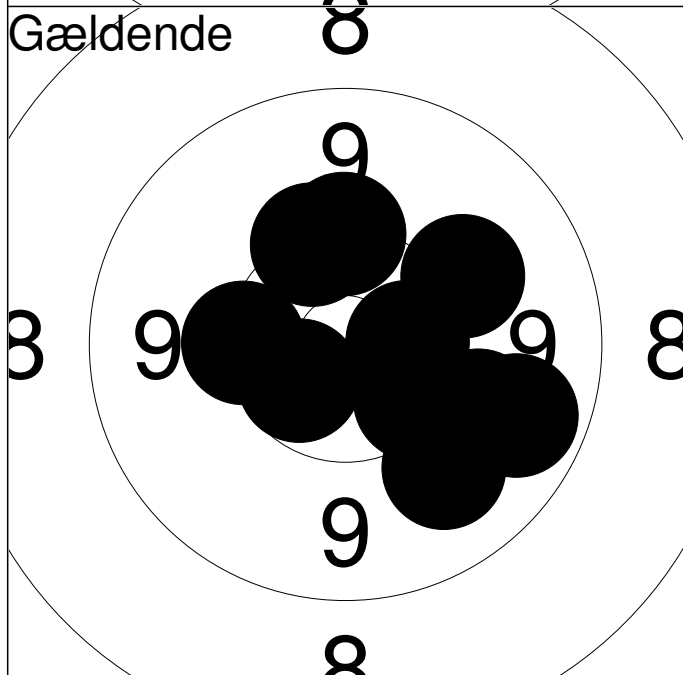

1:	9.7	→
2:	10.3	←
3:	10.0	↗
4:	10.2	↑
5:	10.0	↘
6:	10.4	↘
7:	*10.5	→
8:	10.2	↗
9:	*10.6	↙
10:	9.9	↘
Serie		98.0
Total		98.0

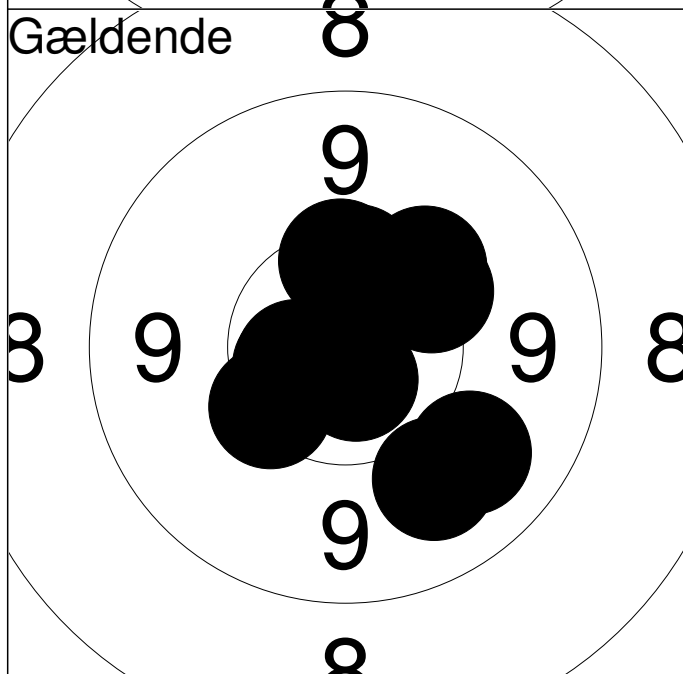

11:	9.9	↘
12:	10.4	↑
13:	10.3	↙
14:	10.3	↗
15:	10.2	↗
16:	*10.6	←
17:	*10.7	↘
18:	*10.6	←
19:	10.4	↑
20:	9.9	↘
Serie		98.0
Total		196.0

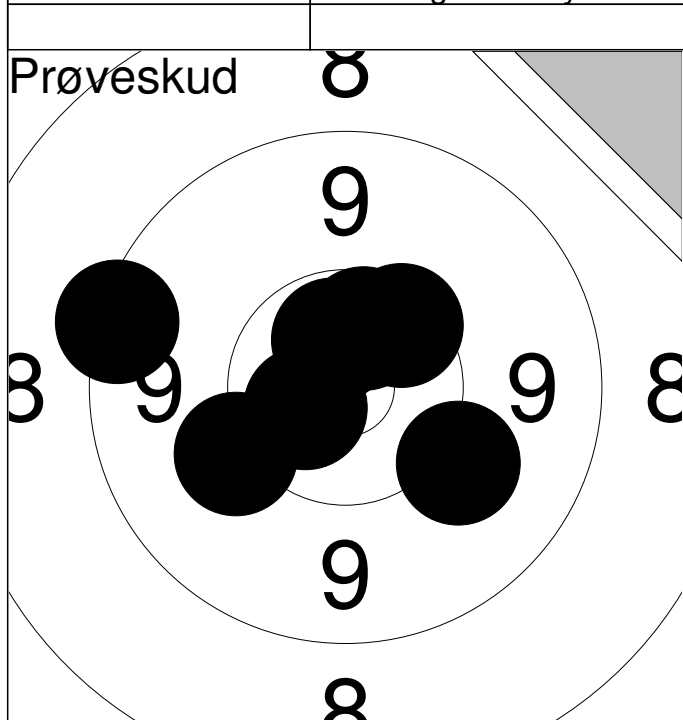

1:	*10.5	↗
2:	10.1	↖
3:	10.4	↗
4:	*10.6	↗
5:	10.0	↘
6:	9.3	↖
7:	*10.6	↖
Serie		69.0
Total		0.0

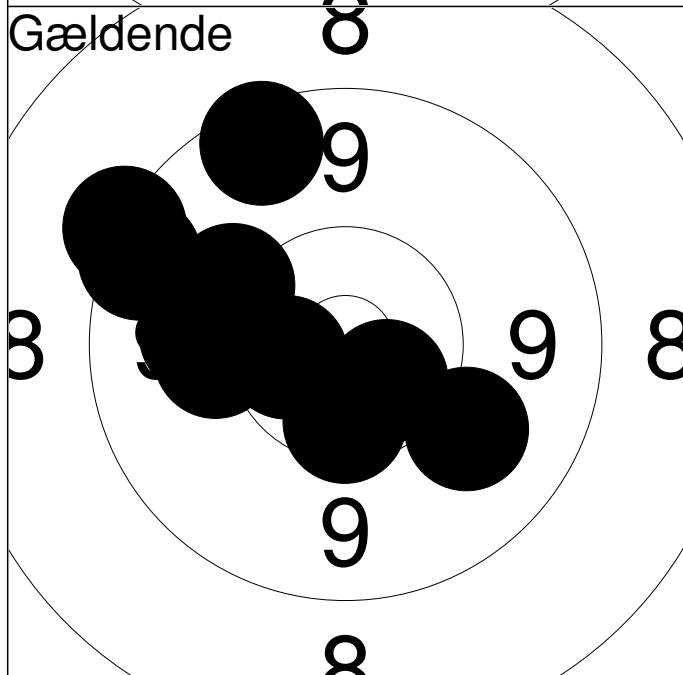

1:	10.1	↖
2:	9.4	↗
3:	10.0	↖
4:	9.2	↗
5:	*10.6	↘
6:	10.0	↘
7:	10.1	↗
8:	*10.4	↘
9:	9.5	↗
10:	*10.5	↖
Serie		97.0
Total		97.0

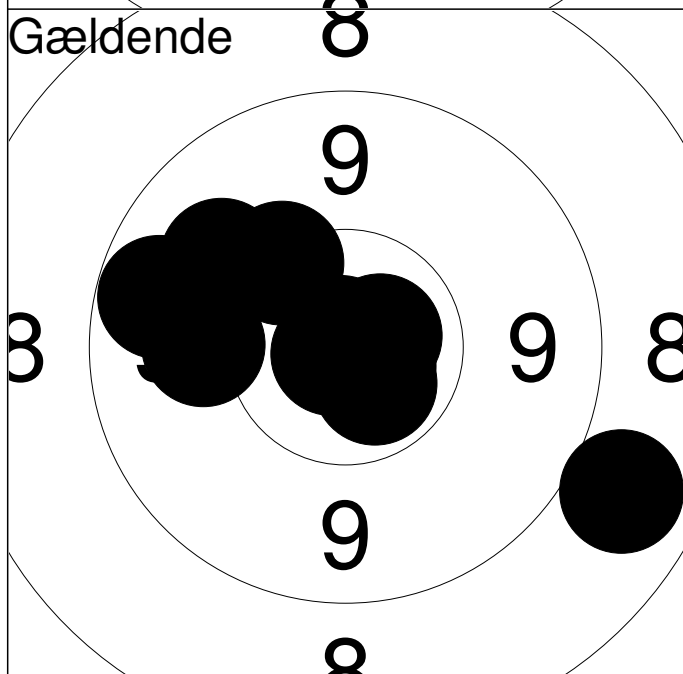

11:	8.8	↘
12:	*10.7	↗
13:	*10.9	↖
14:	*10.6	↘
15:	*10.7	↘
16:	9.6	↖
17:	*10.9	↗
18:	10.0	↖
19:	9.9	↗
20:	10.2	↗
Serie		96.0
Total		193.0

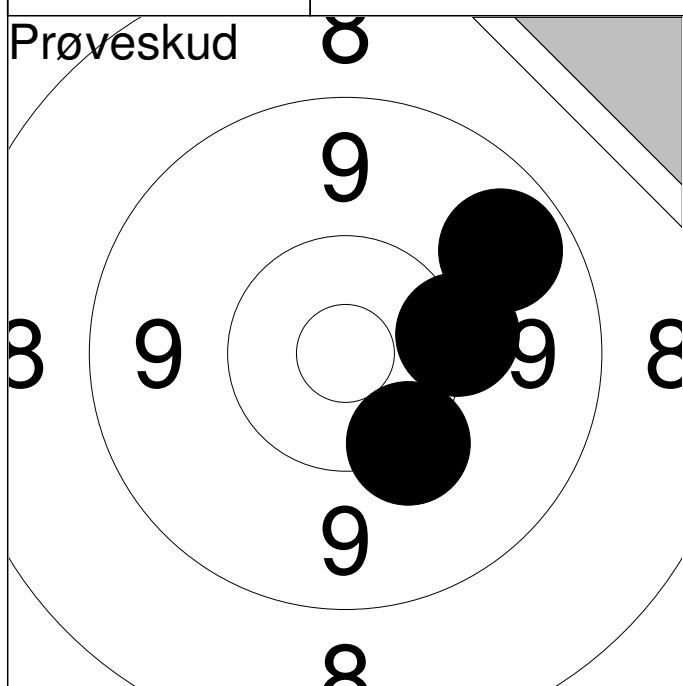

1:	9.7	↗
2:	10.2	↘
3:	10.2	→
Serie		29.0
Total		0.0

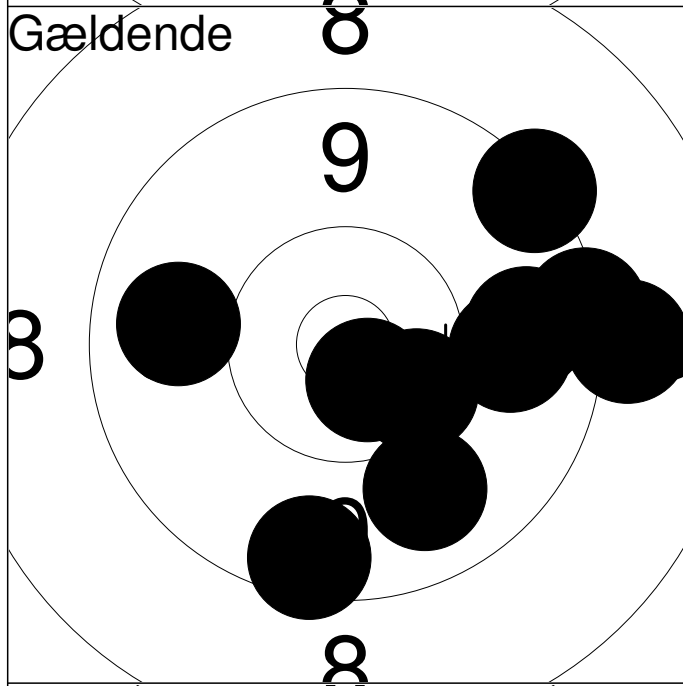

1:	9.3	→
2:	9.8	→
3:	9.8	↘
4:	9.0	→
5:	9.5	↘
6:	9.8	←
7:	*10.7	↘
8:	9.7	→
9:	9.3	↗
10:	10.4	↘
Serie		92.0
Total		92.0

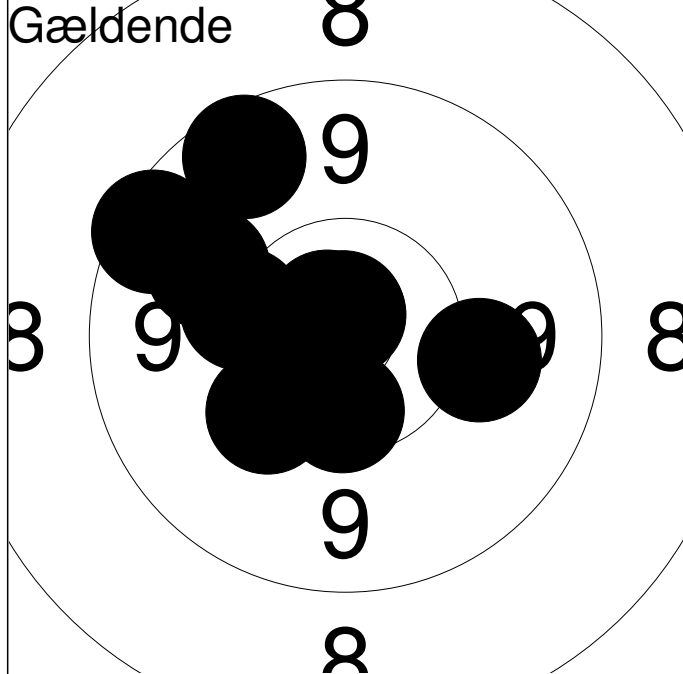

11:	9.9	↗
12:	9.5	↗
13:	10.2	←
14:	9.4	↗
15:	10.0	→
16:	*10.8	↑
17:	10.2	↙
18:	*10.7	↗
19:	*10.8	↑
20:	*10.4	↓
Serie		97.0
Total		189.0

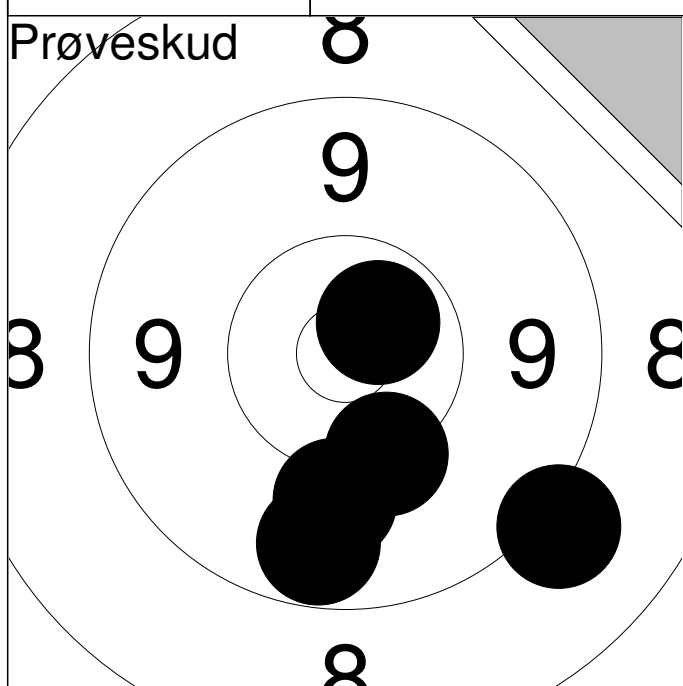

	1:	9.6	↓
	2:	10.0	↓
	3:	10.2	↓
	4:	9.0	↓
	5:	*10.6	↑
Serie			48.0
Total			0.0

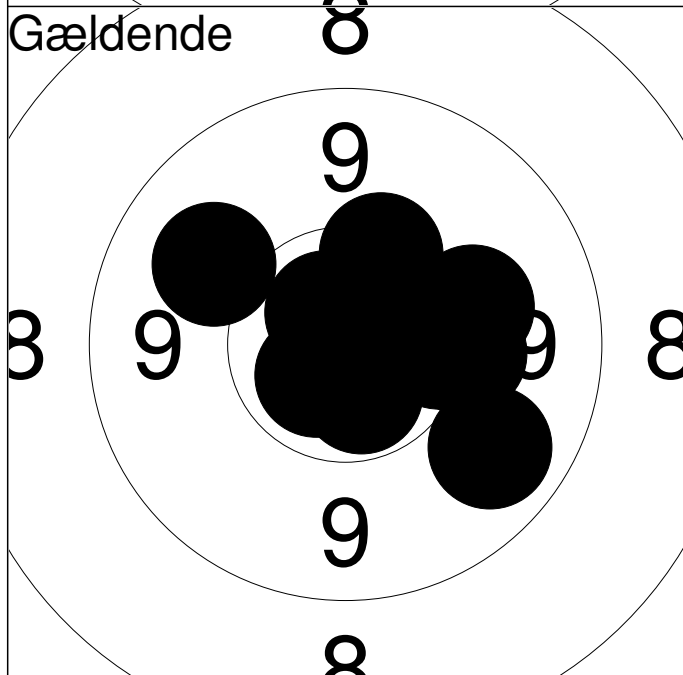

	1:	10.1	→
	2:	*10.6	↓
	3:	10.3	↑
	4:	*10.8	↓
	5:	9.9	↑
	6:	*10.7	↑
	7:	9.7	↓
	8:	*10.7	↙
	9:	10.3	→
	10:	10.1	→
Serie			98.0
Total			98.0

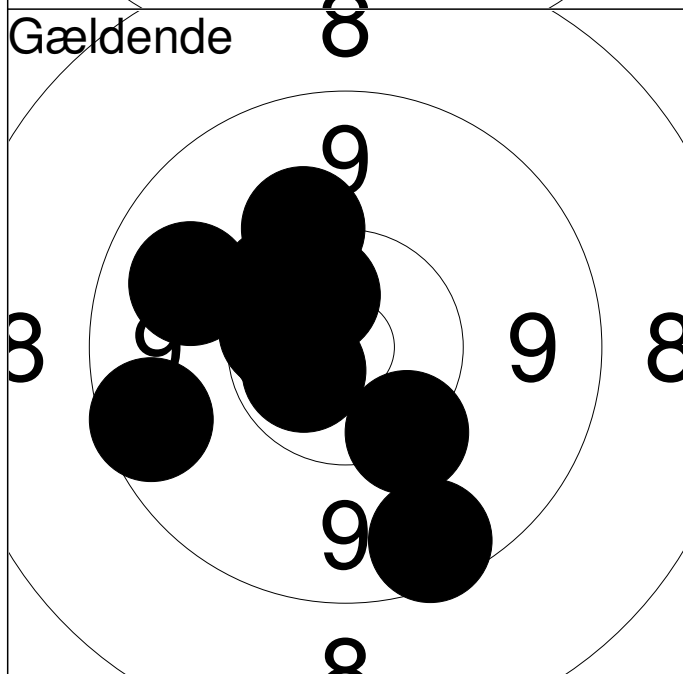

	11:	*10.6	↑
	12:	10.4	↑
	13:	10.1	↑
	14:	*10.6	↙
	15:	*10.5	↑
	16:	10.2	↓
	17:	9.5	↓
	18:	*10.6	↑
	19:	9.5	↙
	20:	9.8	↑
Serie			97.0
Total			195.0

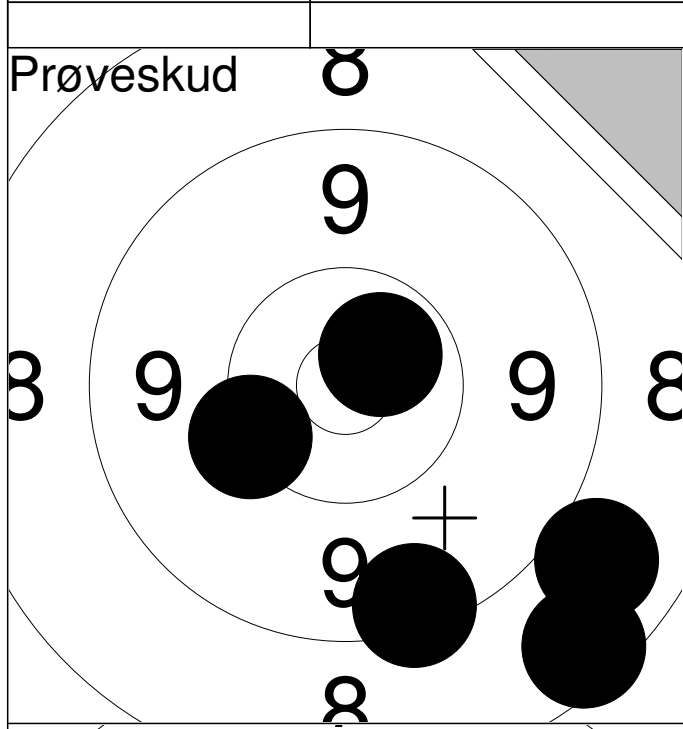

	1:	8.5		↘
	2:	8.8		↘
	3:	9.4		↘
	4:	10.2		↙
	5:	*10.6		↗
Serie				45.0
Total				0.0

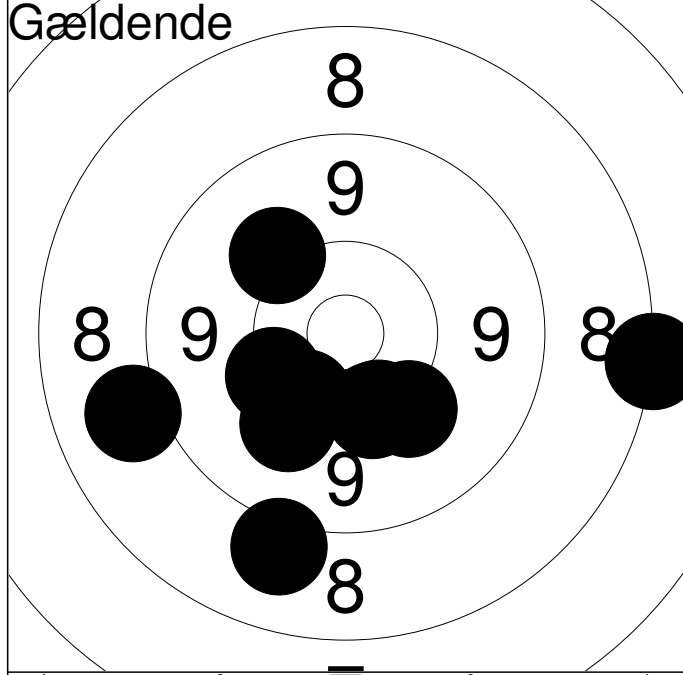

	1:	10.2		↘
	2:	10.2		↘
	3:	9.0		↘
	4:	10.1		↗
	5:	10.2		↙
	6:	8.2		→
	7:	10.3		↘
	8:	10.0		↘
	9:	8.9		↙
	10:	10.1		↘
Serie				95.0
Total				95.0

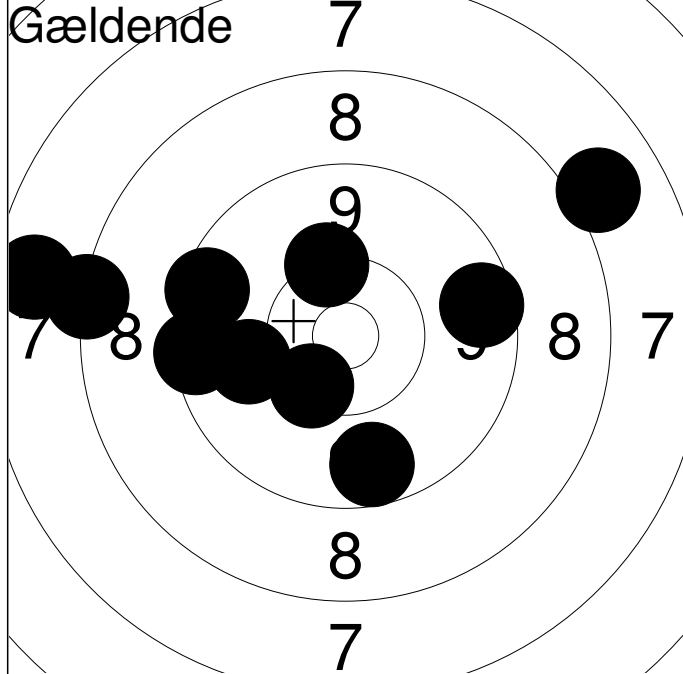

	11:	9.6		↘
	12:	10.0		↙
	13:	7.9		↗
	14:	9.5		→
	15:	9.5		↗
	16:	7.6		↙
	17:	8.2		↙
	18:	9.4		↙
	19:	10.3		↘
	20:	10.2		↗
Serie				88.0
Total				183.0

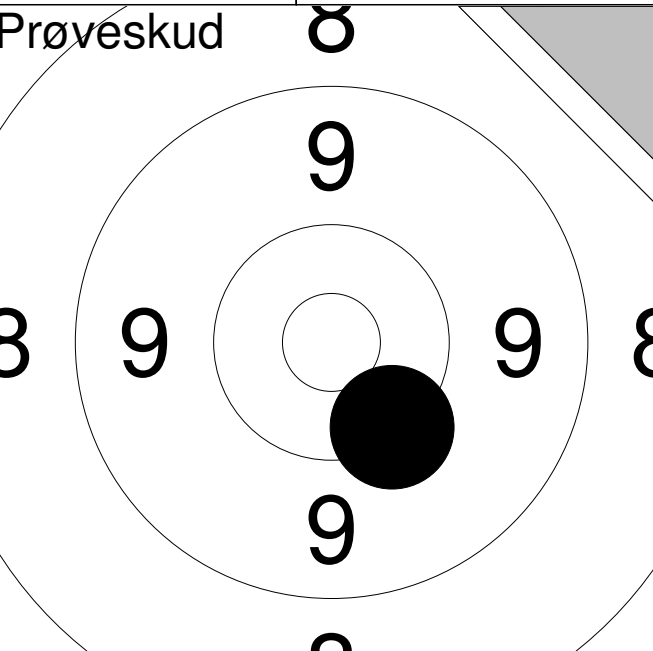
<p>Prøveskud</p> 	<table style="width:100%; border-collapse: collapse;"> <tr> <td style="width: 10%;">1:</td> <td style="width: 10%;">10.3</td> <td style="width: 10%; text-align: center;">↘</td> </tr> <tr> <td colspan="3"><hr/></td> </tr> <tr> <td>Serie</td> <td style="text-align: right;">10.0</td> <td></td> </tr> <tr> <td>Total</td> <td style="text-align: right;">0.0</td> <td></td> </tr> </table>	1:	10.3	↘	<hr/>			Serie	10.0		Total	0.0	
1:	10.3	↘											
<hr/>													
Serie	10.0												
Total	0.0												

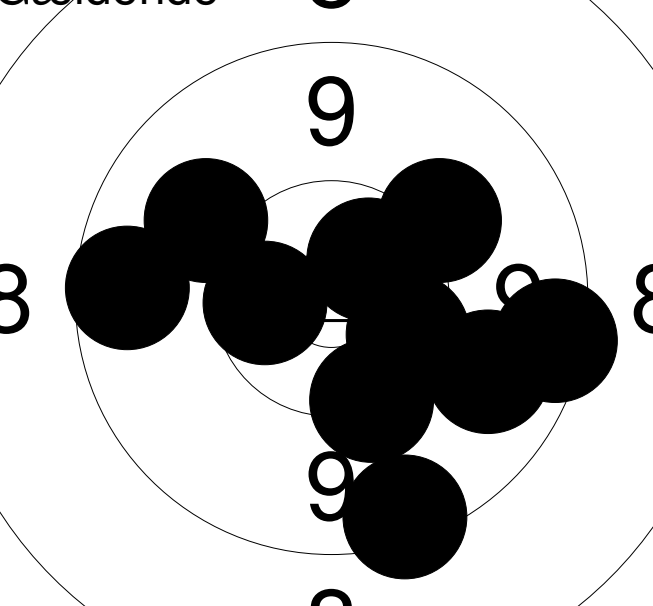
<p>Gældende</p> 	<table style="width:100%; border-collapse: collapse;"> <tr> <td style="width: 10%;">1:</td> <td style="width: 10%;">9.8</td> <td style="width: 10%; text-align: center;">→</td> </tr> <tr> <td>2:</td> <td>9.4</td> <td style="text-align: center;">↘</td> </tr> <tr> <td>3:</td> <td>9.6</td> <td style="text-align: center;">←</td> </tr> <tr> <td>4:</td> <td>10.4</td> <td style="text-align: center;">↘</td> </tr> <tr> <td>5:</td> <td>10.0</td> <td style="text-align: center;">↗</td> </tr> <tr> <td>6:</td> <td>10.2</td> <td style="text-align: center;">↘</td> </tr> <tr> <td>7:</td> <td>*10.6</td> <td style="text-align: center;">↗</td> </tr> <tr> <td>8:</td> <td>*10.5</td> <td style="text-align: center;">←</td> </tr> <tr> <td>9:</td> <td>10.1</td> <td style="text-align: center;">↗</td> </tr> <tr> <td>10:</td> <td>9.4</td> <td style="text-align: center;">→</td> </tr> <tr> <td colspan="3"><hr/></td> </tr> <tr> <td>Serie</td> <td style="text-align: right;">96.0</td> <td></td> </tr> <tr> <td>Total</td> <td style="text-align: right;">96.0</td> <td></td> </tr> </table>	1:	9.8	→	2:	9.4	↘	3:	9.6	←	4:	10.4	↘	5:	10.0	↗	6:	10.2	↘	7:	*10.6	↗	8:	*10.5	←	9:	10.1	↗	10:	9.4	→	<hr/>			Serie	96.0		Total	96.0	
1:	9.8	→																																						
2:	9.4	↘																																						
3:	9.6	←																																						
4:	10.4	↘																																						
5:	10.0	↗																																						
6:	10.2	↘																																						
7:	*10.6	↗																																						
8:	*10.5	←																																						
9:	10.1	↗																																						
10:	9.4	→																																						
<hr/>																																								
Serie	96.0																																							
Total	96.0																																							

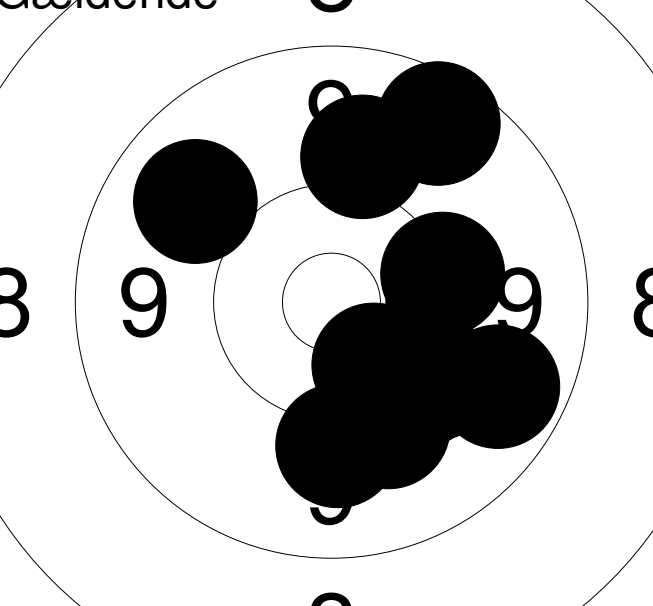
<p>Gældende</p> 	<table style="width:100%; border-collapse: collapse;"> <tr> <td style="width: 10%;">11:</td> <td style="width: 10%;">10.0</td> <td style="width: 10%; text-align: center;">↑</td> </tr> <tr> <td>12:</td> <td>10.1</td> <td style="text-align: center;">↘</td> </tr> <tr> <td>13:</td> <td>10.0</td> <td style="text-align: center;">↘</td> </tr> <tr> <td>14:</td> <td>9.8</td> <td style="text-align: center;">↗</td> </tr> <tr> <td>15:</td> <td>10.1</td> <td style="text-align: center;">↘</td> </tr> <tr> <td>16:</td> <td>9.7</td> <td style="text-align: center;">↘</td> </tr> <tr> <td>17:</td> <td>9.5</td> <td style="text-align: center;">↗</td> </tr> <tr> <td>18:</td> <td>10.2</td> <td style="text-align: center;">→</td> </tr> <tr> <td>19:</td> <td>*10.4</td> <td style="text-align: center;">↘</td> </tr> <tr> <td>20:</td> <td>10.0</td> <td style="text-align: center;">↘</td> </tr> <tr> <td colspan="3"><hr/></td> </tr> <tr> <td>Serie</td> <td style="text-align: right;">97.0</td> <td></td> </tr> <tr> <td>Total</td> <td style="text-align: right;">193.0</td> <td></td> </tr> </table>	11:	10.0	↑	12:	10.1	↘	13:	10.0	↘	14:	9.8	↗	15:	10.1	↘	16:	9.7	↘	17:	9.5	↗	18:	10.2	→	19:	*10.4	↘	20:	10.0	↘	<hr/>			Serie	97.0		Total	193.0	
11:	10.0	↑																																						
12:	10.1	↘																																						
13:	10.0	↘																																						
14:	9.8	↗																																						
15:	10.1	↘																																						
16:	9.7	↘																																						
17:	9.5	↗																																						
18:	10.2	→																																						
19:	*10.4	↘																																						
20:	10.0	↘																																						
<hr/>																																								
Serie	97.0																																							
Total	193.0																																							

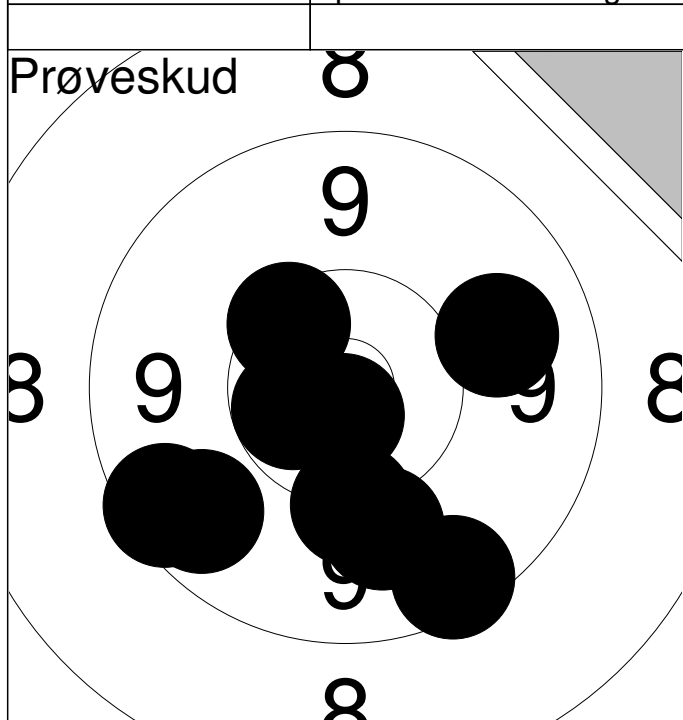

1:	9.9	→
2:	*10.6	←
3:	9.5	↓
4:	9.7	↙
5:	9.5	↙
6:	10.2	↓
7:	10.0	↓
8:	10.4	↗
9:	*10.8	↓
Serie		86.0
Total		0.0

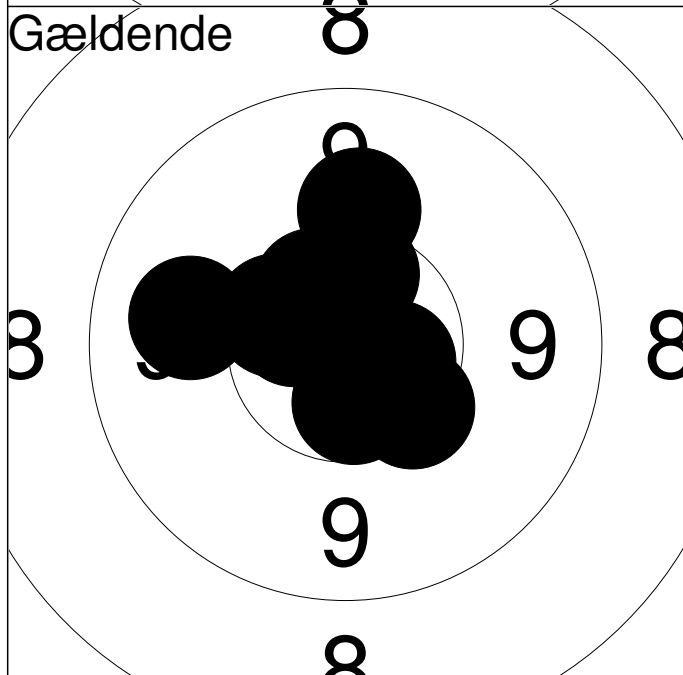

1:	9.9	←
2:	10.3	↓
3:	*10.6	↓
4:	*10.4	↗
5:	*10.5	↑
6:	*10.6	↗
7:	*10.6	↗
8:	10.0	↑
9:	*10.5	↗
10:	*10.6	↓
Serie		99.0
Total		99.0

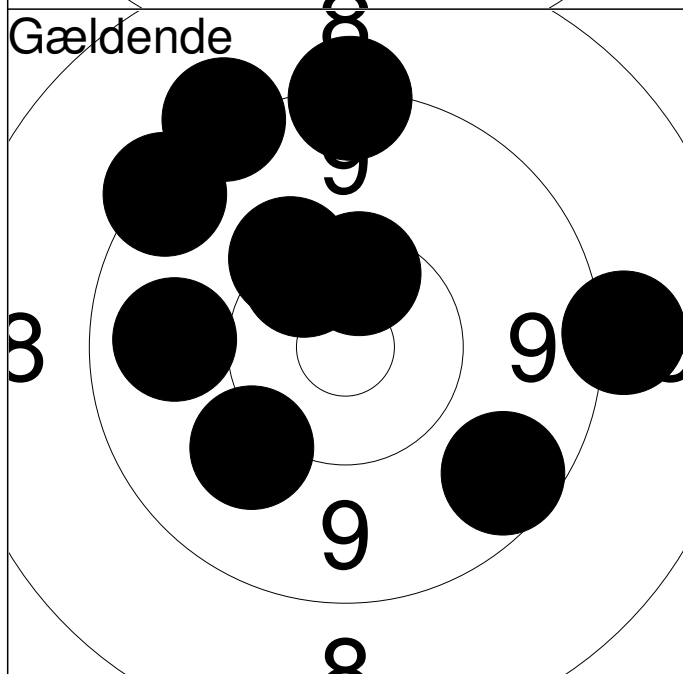

11:	10.3	↗
12:	10.0	↙
13:	9.2	↑
14:	9.0	→
15:	9.2	↗
16:	*10.4	↗
17:	9.3	↗
18:	10.4	↗
19:	9.8	←
20:	9.6	↓
Serie		94.0
Total		193.0

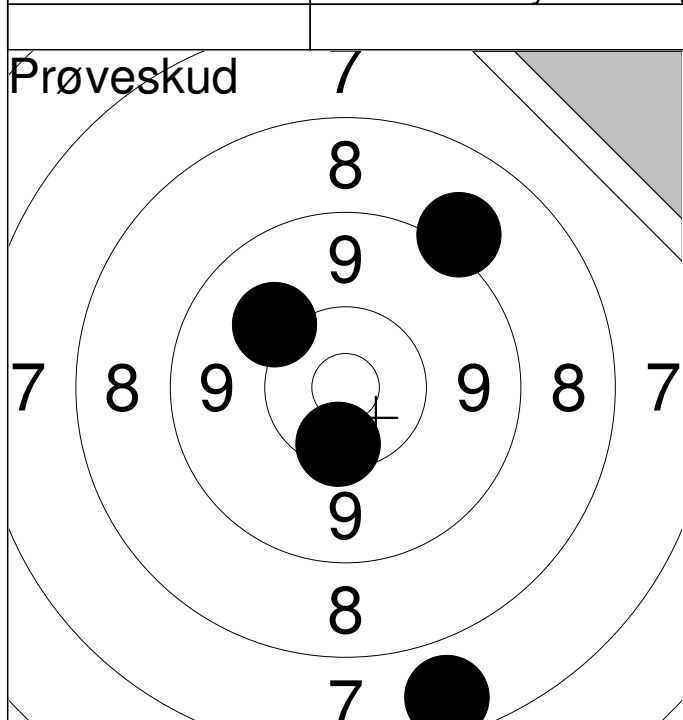

1:	9.0	↗
2:	7.6	↘
3:	10.0	↗
4:	10.4	↘
Serie		36.0
Total		0.0

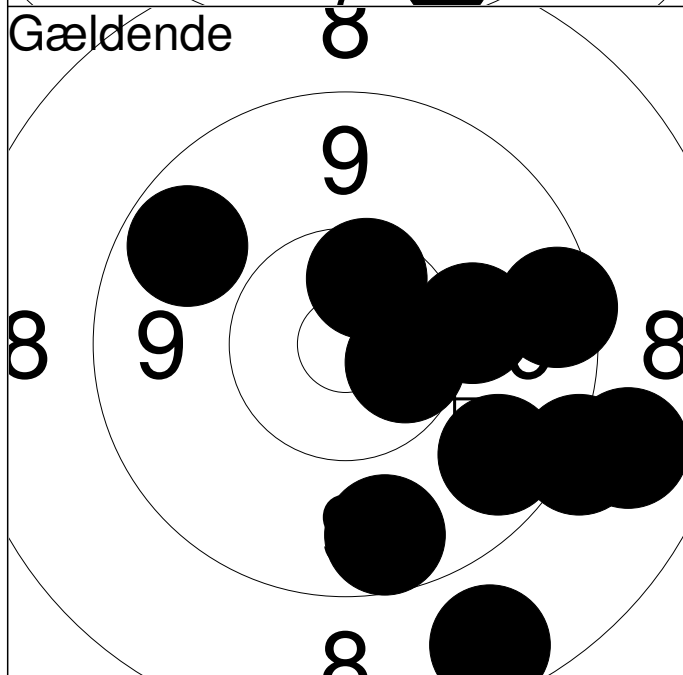

1:	9.6	↘
2:	10.1	→
3:	*10.5	↗
4:	8.8	↘
5:	*10.5	↘
6:	9.4	→
7:	8.6	↘
8:	9.1	↘
9:	9.7	↗
10:	9.6	↘
Serie		91.0
Total		91.0

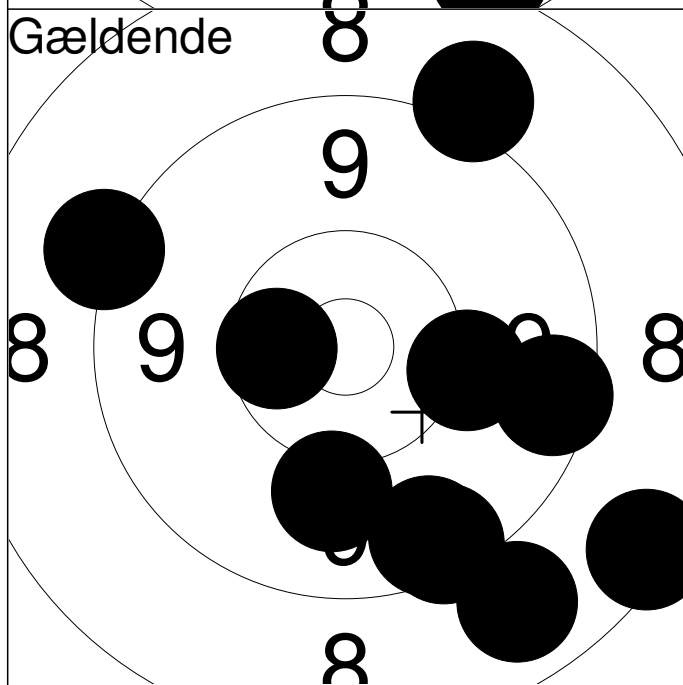

11:	10.1	→
12:	*10.5	←
13:	10.0	↖
14:	8.8	↘
15:	9.5	↘
16:	9.0	↗
17:	9.1	↗
18:	9.5	↘
19:	8.4	↘
20:	9.4	↘
Serie		91.0
Total		182.0

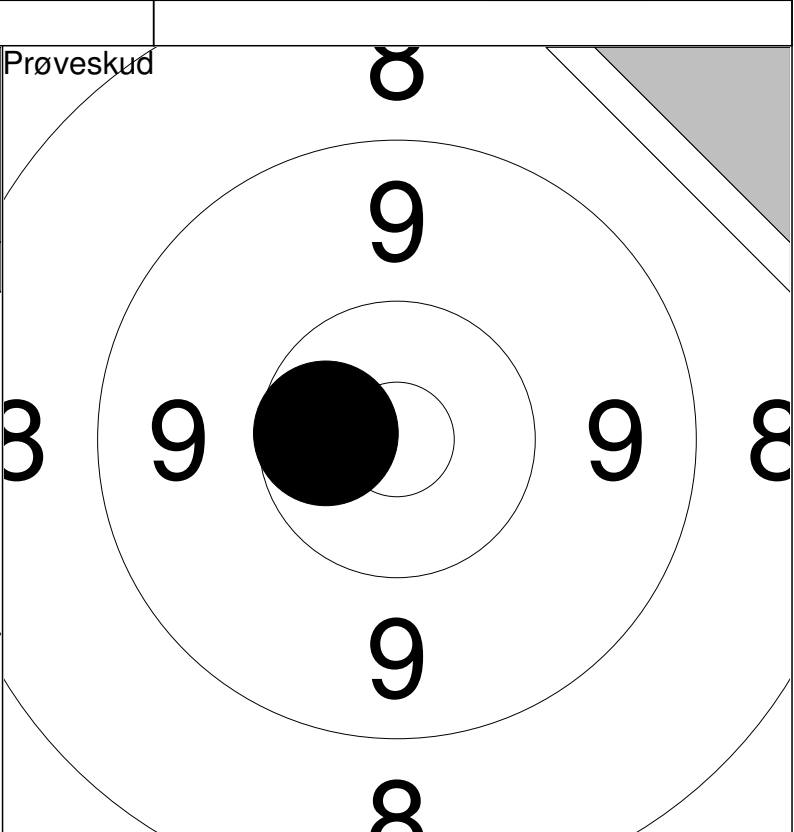
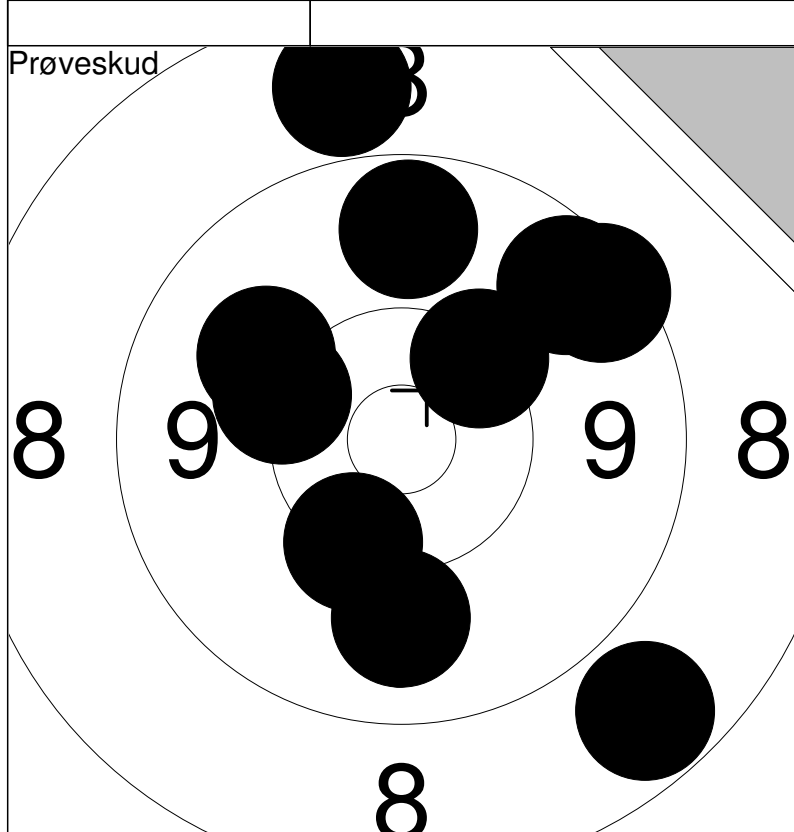

1: 8.7 ↘	6: 10.3 ↙	Serie	92.0
2: 10.2 ↖	7: 10.0 ↖		
3: 9.9 ↓	8: 8.7 ↑	Total	0.0
4: 10.3 ↗	9: 9.6 ↗		
5: 9.7 ↑	10: 9.4 ↗		

11: *10.5 ←	Serie	10.0
	Total	0.0

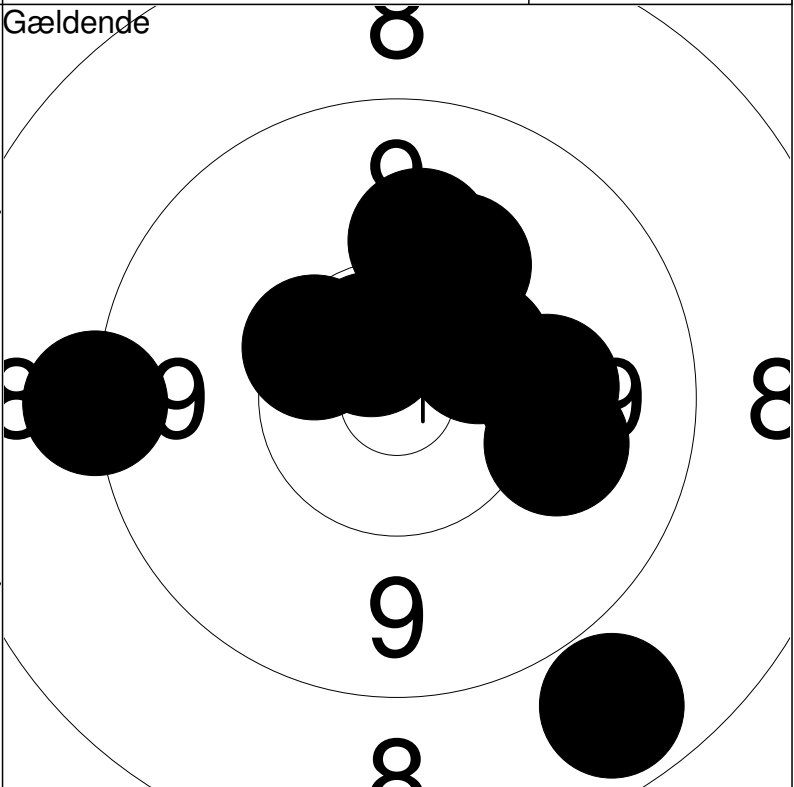
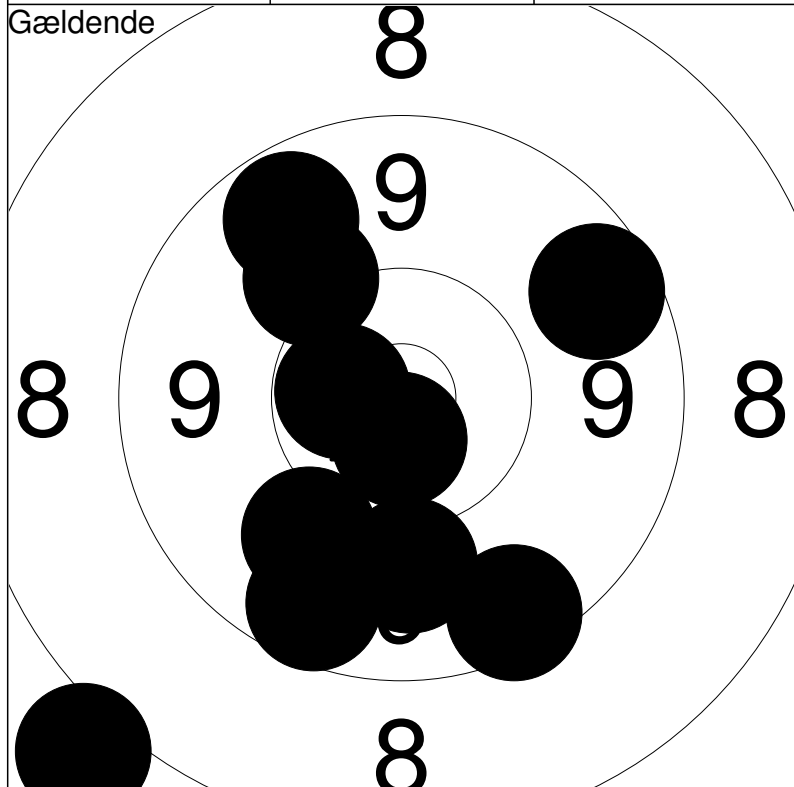

1: 9.9 ↙	6: *10.6 ←	Serie	91.0
2: 9.9 ↓	7: 9.6 ↗		
3: 10.0 ↗	8: 9.7 ↑	Total	91.0
4: *10.7 ↓	9: 7.9 ↙		
5: 9.4 ↓	10: 9.6 ↙		

11: 9.2 ←	16: 10.4 ↖	Serie	97.0
12: 10.0 →	17: 10.3 ↑		
13: 8.7 ↘	18: 10.4 ↗	Total	188.0
14: *10.6 ↗	19: 10.1 →		
15: 10.1 ↑	20: 10.0 ↑		

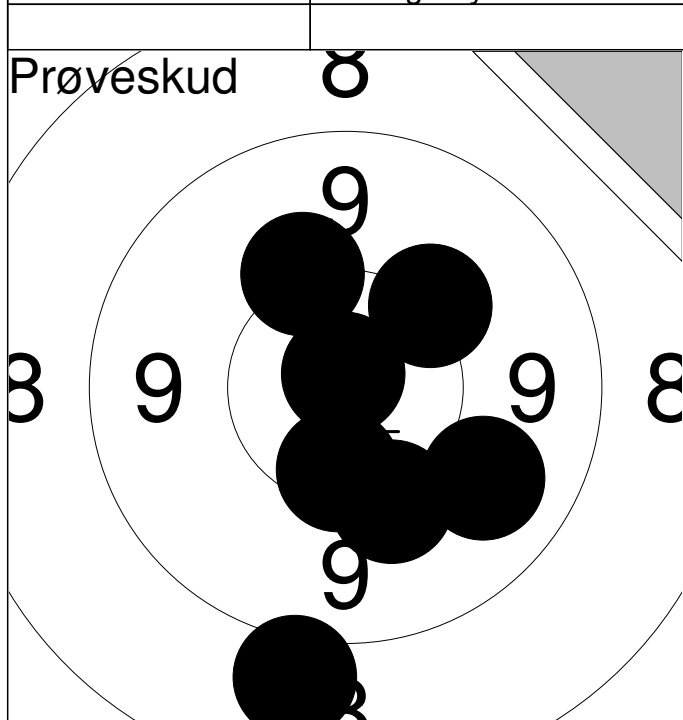

1:	10.2	↗
2:	9.8	↘
3:	10.1	↘
4:	8.9	↘
5:	10.4	↘
6:	10.1	↗
7:	*10.9	↗
Serie		67.0
Total		0.0

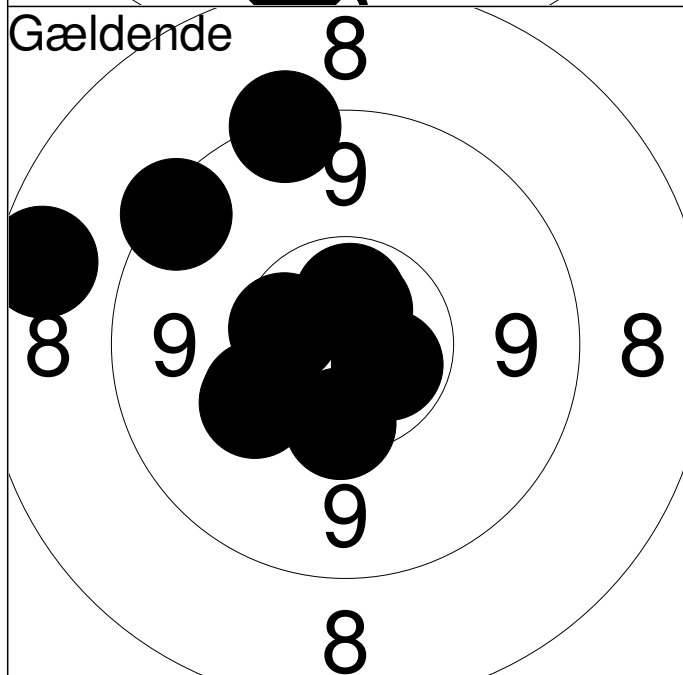

1:	8.5	↖
2:	*10.7	↗
3:	*10.6	↗
4:	9.3	↗
5:	9.2	↗
6:	10.2	↖
7:	*10.6	↘
8:	*10.5	↖
9:	10.2	↖
10:	10.4	↘
Serie		96.0
Total		96.0

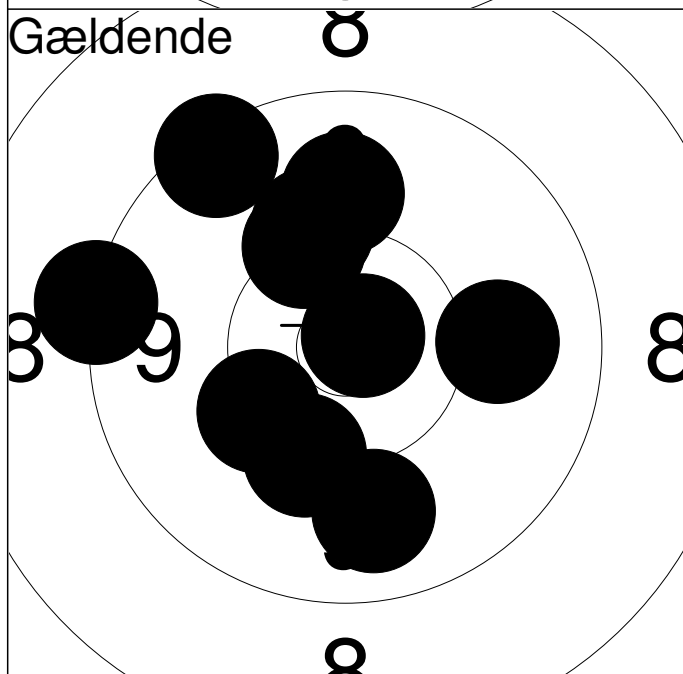

11:	10.2	↖
12:	9.2	↖
13:	9.9	→
14:	10.2	↗
15:	*10.8	↗
16:	10.1	↗
17:	9.4	↗
18:	9.9	↗
19:	10.2	↘
20:	9.8	↘
Serie		95.0
Total		191.0

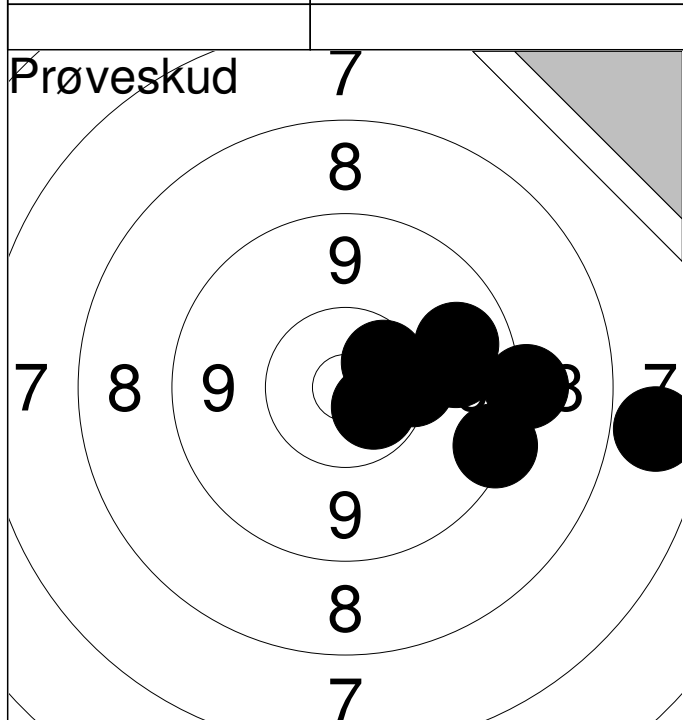

1:	7.7	→
2:	9.3	↘
3:	9.8	→
4:	10.3	→
5:	9.1	→
6:	9.8	→
7:	*10.5	↗
8:	*10.6	↘
Serie		73.0
Total		0.0

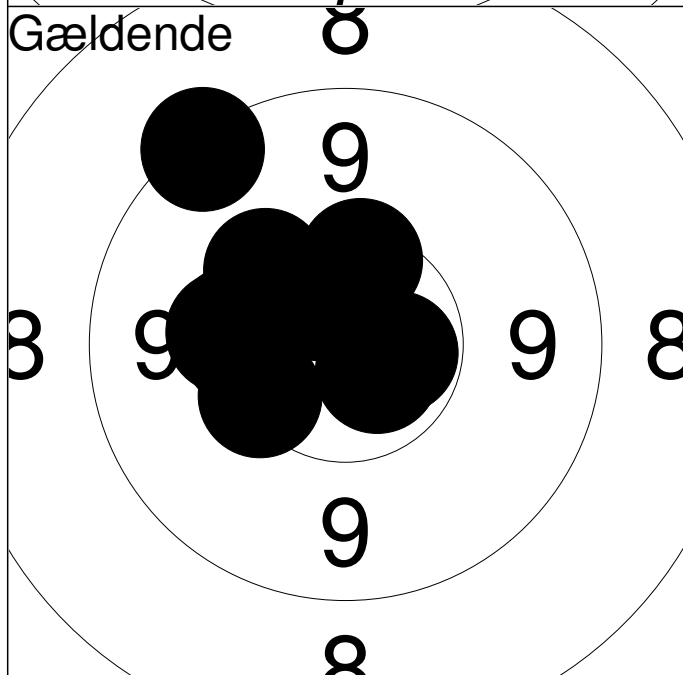

1:	10.4	↑
2:	*10.6	→
3:	10.2	←
4:	*10.7	↘
5:	*10.6	↗
6:	10.2	↗
7:	10.3	↖
8:	10.2	←
9:	9.3	↗
10:	10.3	←
Serie		99.0
Total		99.0

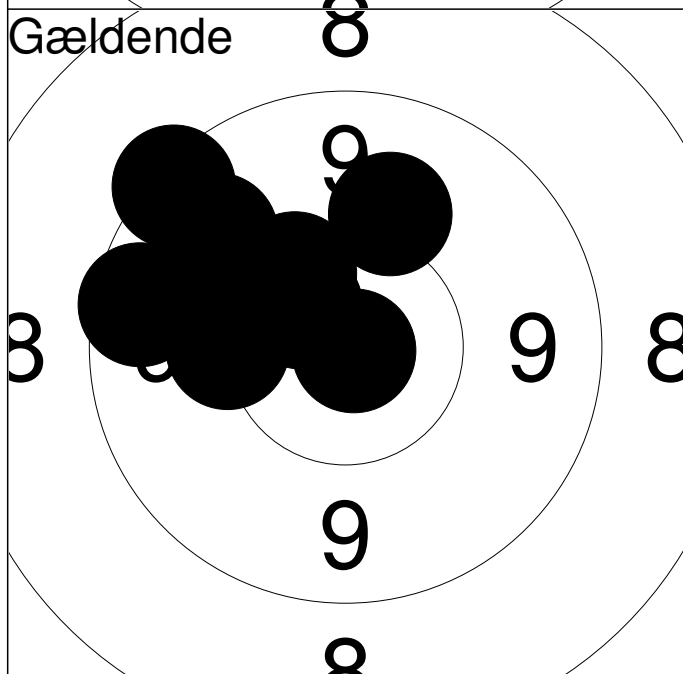

11:	9.5	←
12:	10.2	←
13:	10.0	↗
14:	10.0	↗
15:	9.8	↗
16:	9.3	↗
17:	*10.9	↘
18:	10.2	↗
19:	*10.5	↗
20:	10.4	↗
Serie		97.0
Total		196.0

Vadum Skf.

MB3

Prøveskud

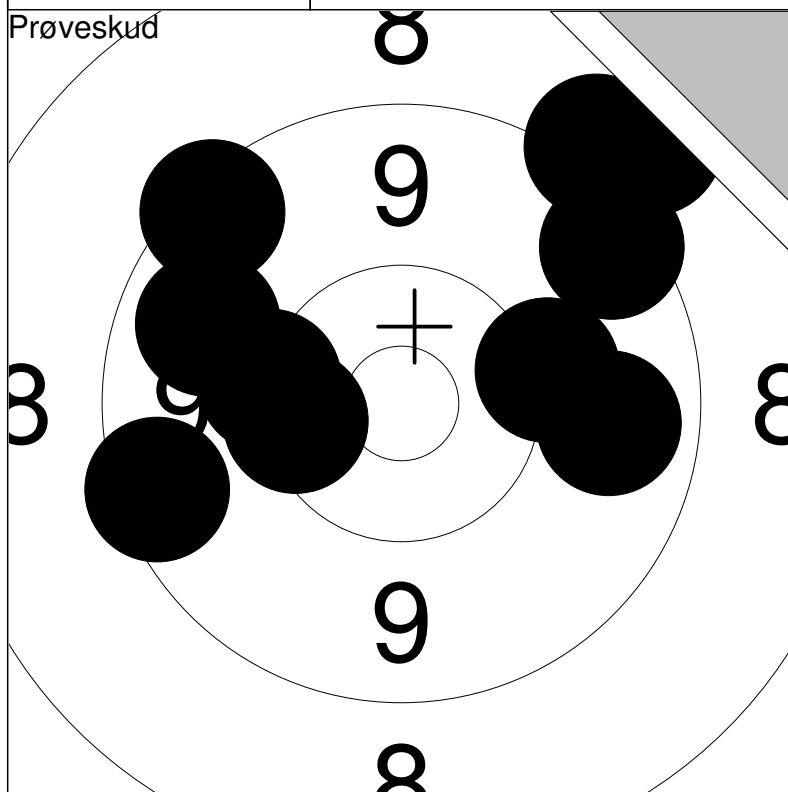

Prøveskud

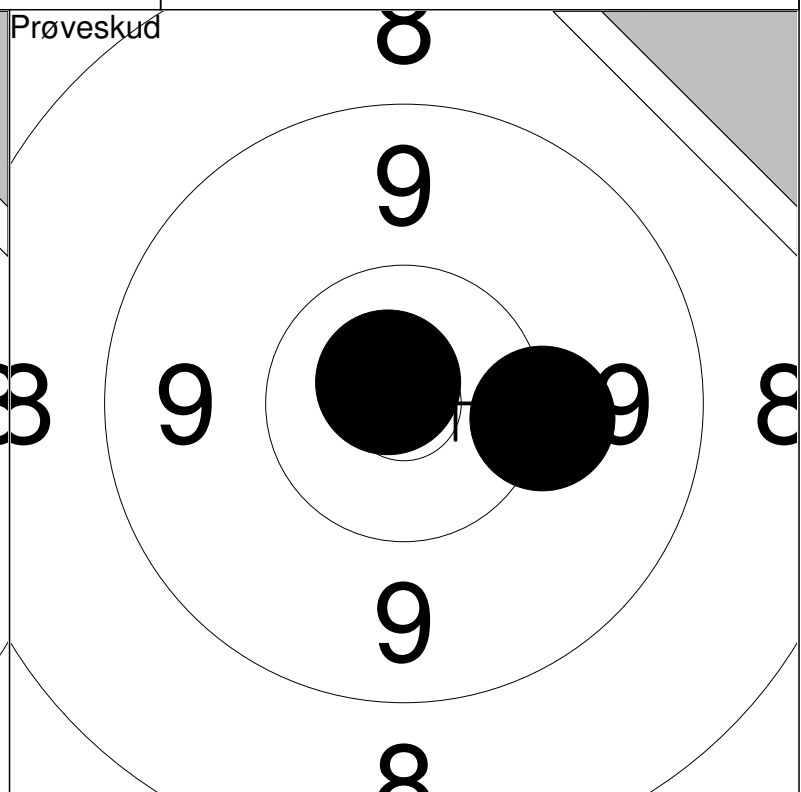

1:	9.0	↗	6:	9.4	↖
2:	10.1	→	7:	10.3	↖
3:	10.2	↖	8:	8.8	↗
4:	9.7	↖	9:	9.4	↖
5:	9.7	→	10:	9.4	↗

Serie	92.0
Total	0.0

11:	10.2	→	12:	*10.8	↗
-----	------	---	-----	-------	---

Serie	20.0
Total	0.0

Gældende

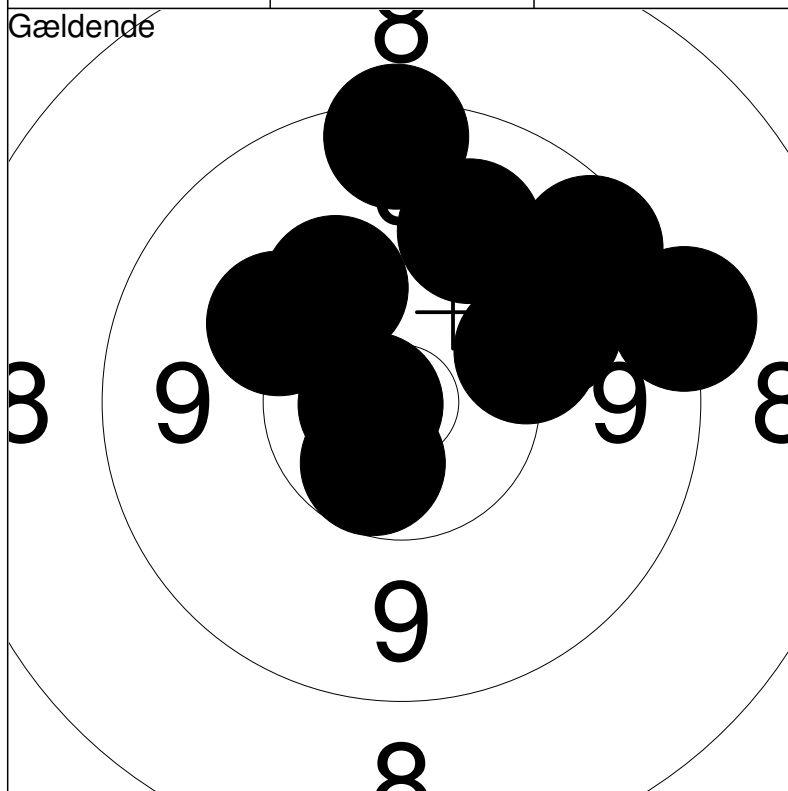

Gældende

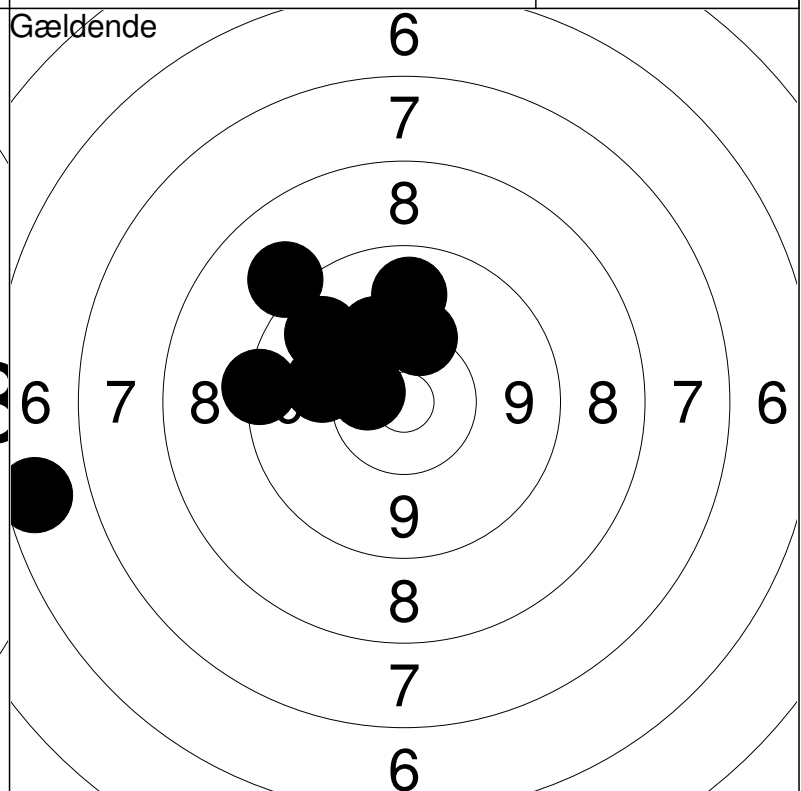

1:	10.0	↗	6:	10.2	↖
2:	9.2	→	7:	9.5	↗
3:	*10.8	↖	8:	*10.6	↘
4:	9.9	↗	9:	10.2	↗
5:	10.1	↖	10:	9.4	↗

Serie	96.0
Total	96.0

11:	10.0	↖	12:	9.0	↗
13:	10.1	↗	14:	9.8	↗
15:	10.4	↖			

16:	10.2	↗	17:	9.8	↖
18:	6.5	↖	19:	9.3	↖
20:	*10.5	↖			

Serie	92.0
Total	188.0

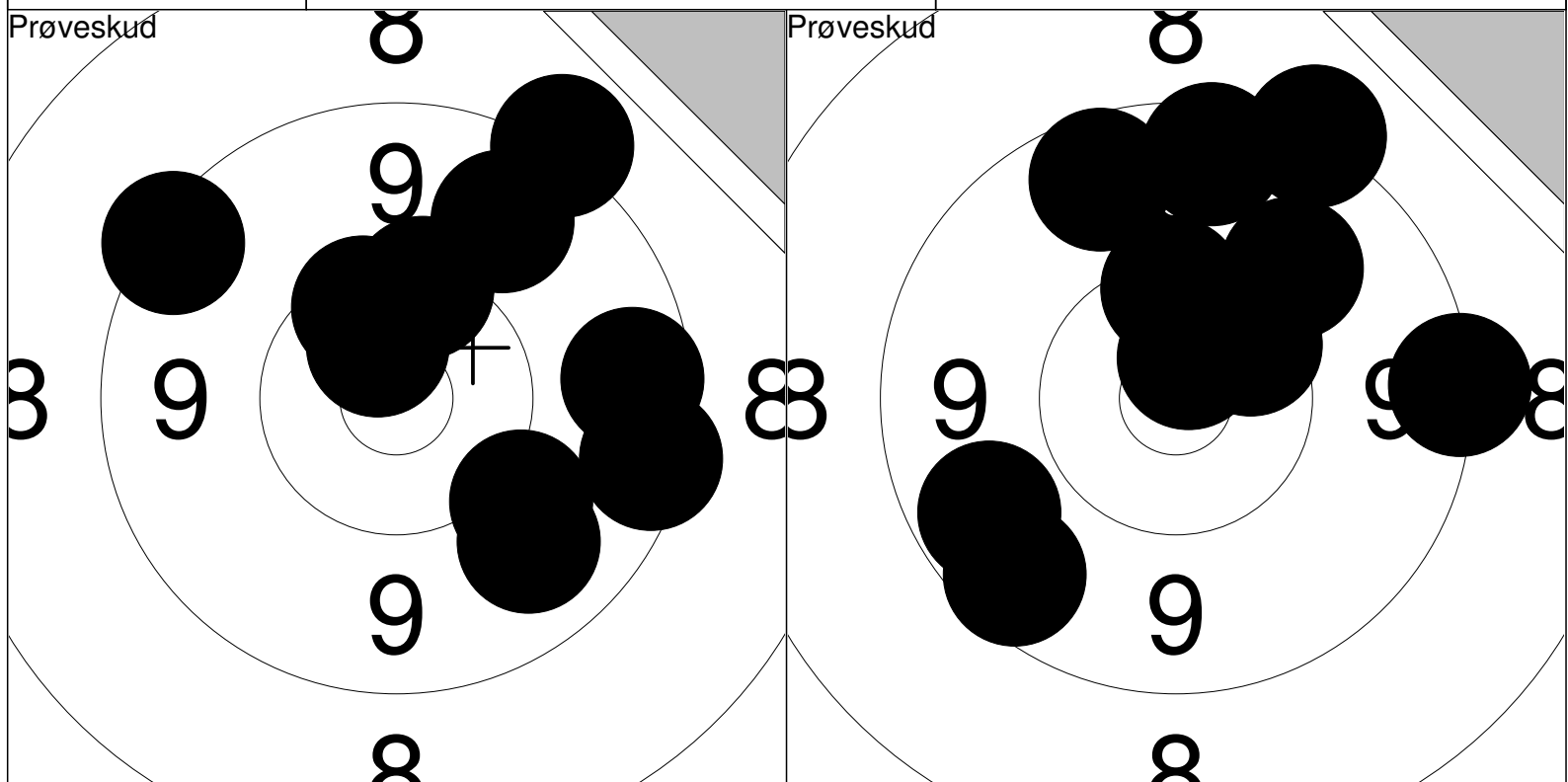

1: 10.4 ↗	6: *10.6 ↗			11: *10.4 ↗	16: 9.2 ↗		
2: 9.4 →	7: 9.1 ↗			Serie	94.0		
3: 10.0 ↘	8: 9.5 →			13: 9.6 ↗	18: *10.7 ↗		
4: 9.3 ↗	9: 9.8 ↘			Total	0.0		
5: 9.7 ↗	10: 10.3 ↗			15: 10.3 ↗	20: 9.7 ↘		

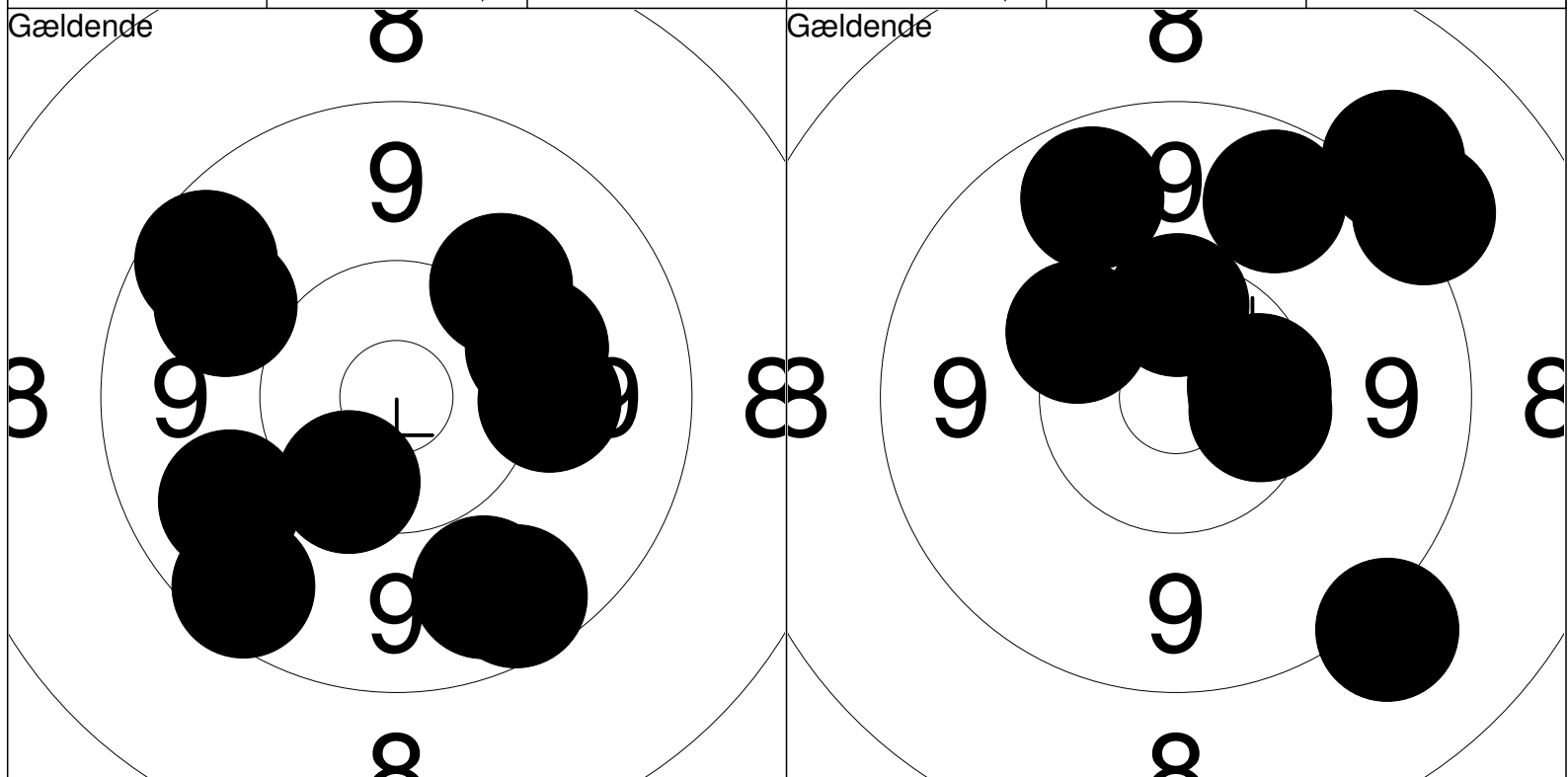

1: 9.8 ↖	6: 9.5 ↖			11: *10.5 →	16: *10.5 →		
2: 9.6 ↗	7: 10.4 ↖			Serie	94.0		
3: 9.8 ↗	8: 10.1 →			13: *10.4 ↗	18: 10.3 ↖		
4: 10.1 →	9: 10.1 ↗			Total	94.0		
5: 9.7 ↘	10: 9.6 ↘			15: 9.7 ↗	20: 9.7 ↗		

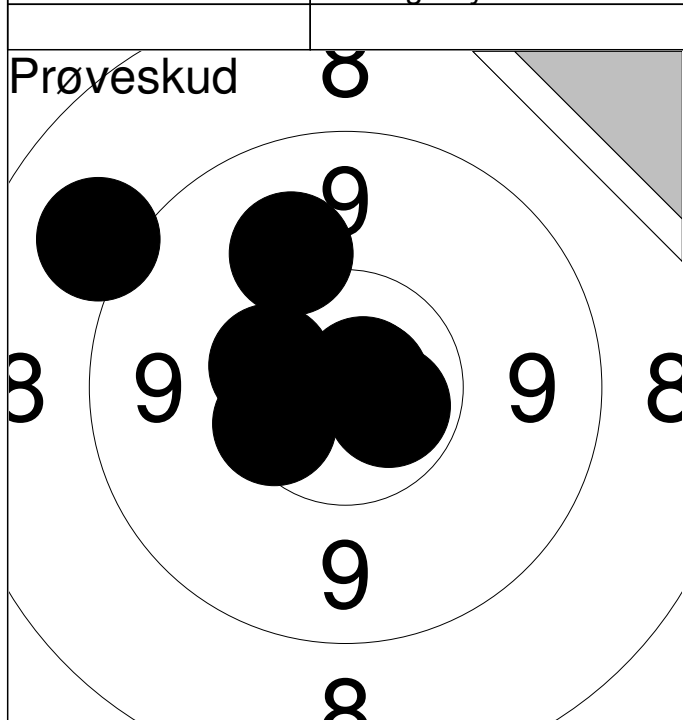

1:	8.9	↗	
2:	*10.8	→	
3:	*10.4	↖	
4:	*10.8	↗	
5:	10.4	↖	
6:	10.0	↗	
7:	*10.5	↖	
8:	*10.6	↘	
Serie		78.0	
Total		0.0	

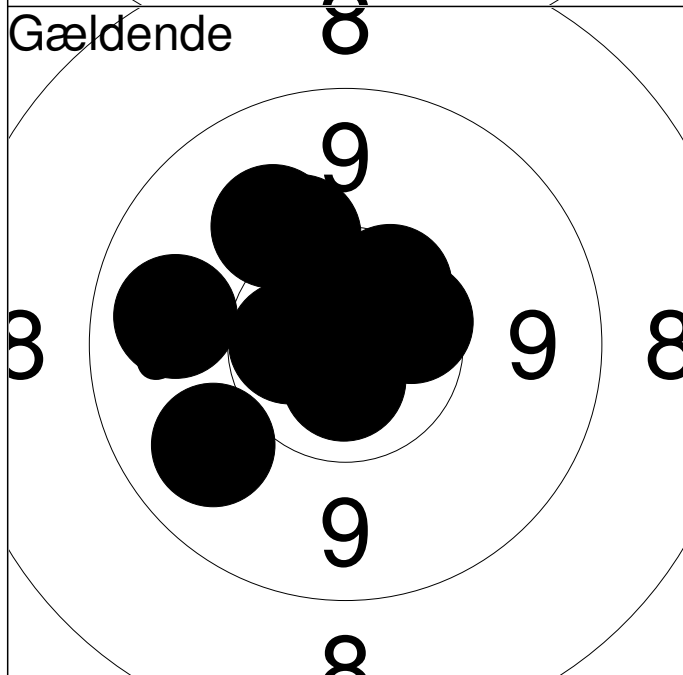

1:	*10.5	↗	
2:	10.2	↗	
3:	*10.7	↘	
4:	10.0	↗	
5:	9.8	↖	
6:	*10.5	→	
7:	*10.7	↗	
8:	*10.8	↑	
9:	9.8	↖	
10:	*10.6	↖	
Serie		98.0	
Total		98.0	

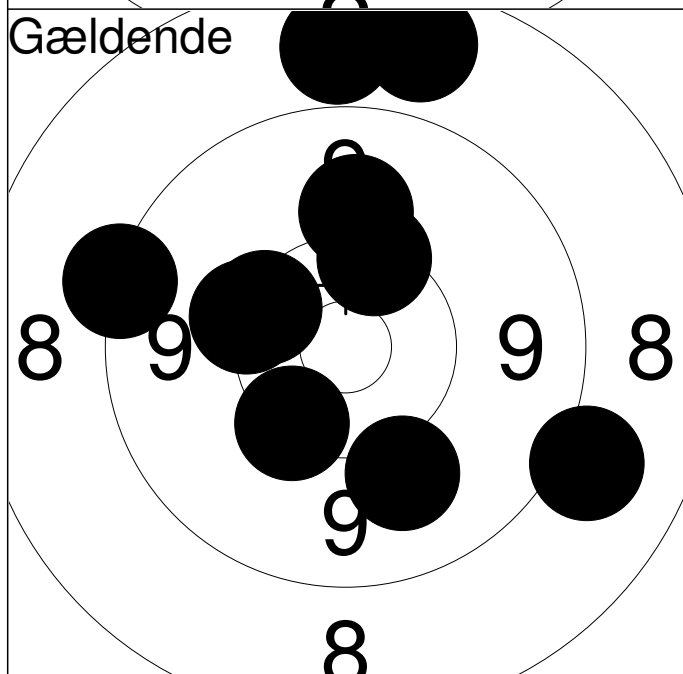

11:	9.0	↘	
12:	10.0	↑	
13:	9.2	↖	
14:	10.0	↘	
15:	10.3	↖	
16:	10.2	↖	
17:	8.7	↑	
18:	10.3	↗	
19:	8.6	↗	
20:	10.3	↖	
Serie		94.0	
Total		192.0	

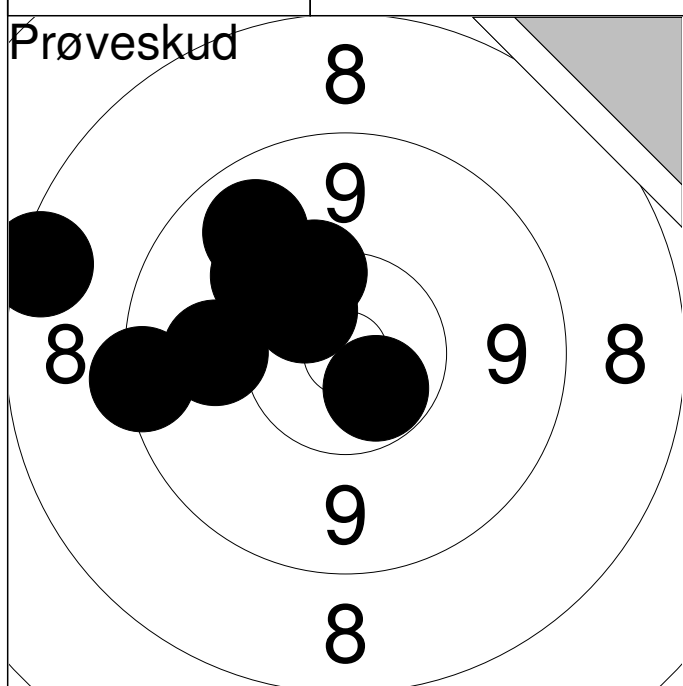

1:	9.3	←
2:	9.9	←
3:	8.4	↑
4:	9.8	↗
5:	10.3	↗
6:	*10.6	↘
7:	10.1	↗
8:	*10.5	↗
Serie		75.0
Total		0.0

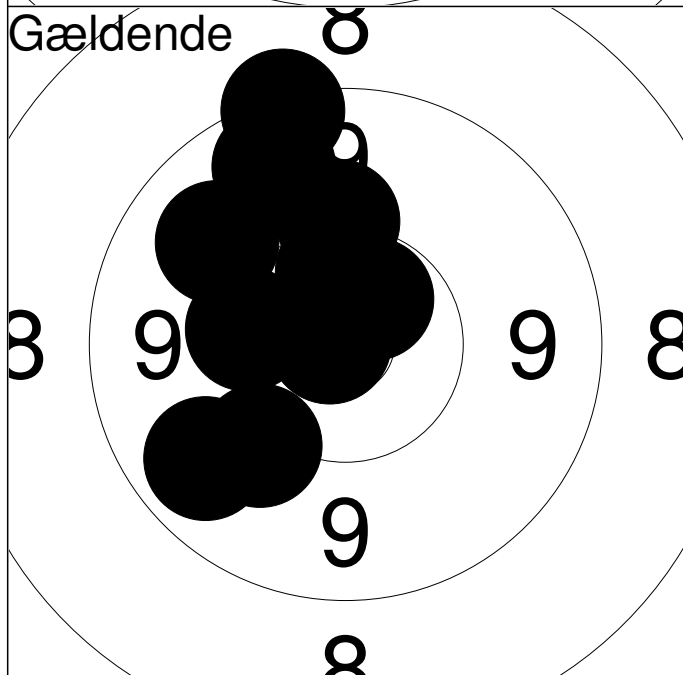

1:	9.8	↗
2:	*10.8	←
3:	*10.5	↑
4:	10.3	←
5:	*10.6	↗
6:	9.3	↑
7:	10.1	↑
8:	10.1	↘
9:	9.7	↘
10:	9.6	↑
Serie		96.0
Total		96.0

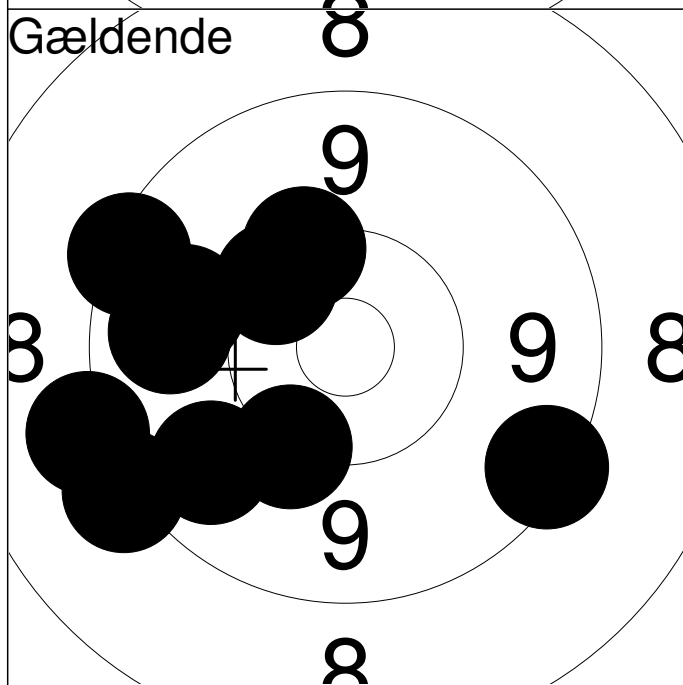

11:	9.3	↘
12:	9.1	←
13:	9.7	↘
14:	9.1	↘
15:	10.2	↘
16:	9.8	←
17:	9.8	↑
18:	9.3	↑
19:	10.3	↗
20:	10.2	↑
Serie		93.0
Total		189.0

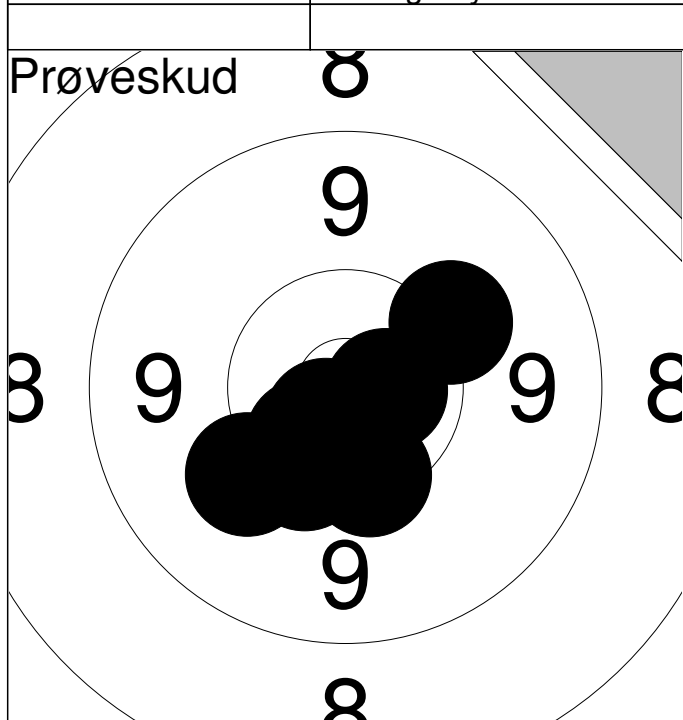

1:	10.1	↙
2:	10.3	↓
3:	*10.7	→
4:	10.3	↙
5:	10.1	→
6:	*10.5	↙
7:	*10.7	↙
Serie		70.0
Total		0.0

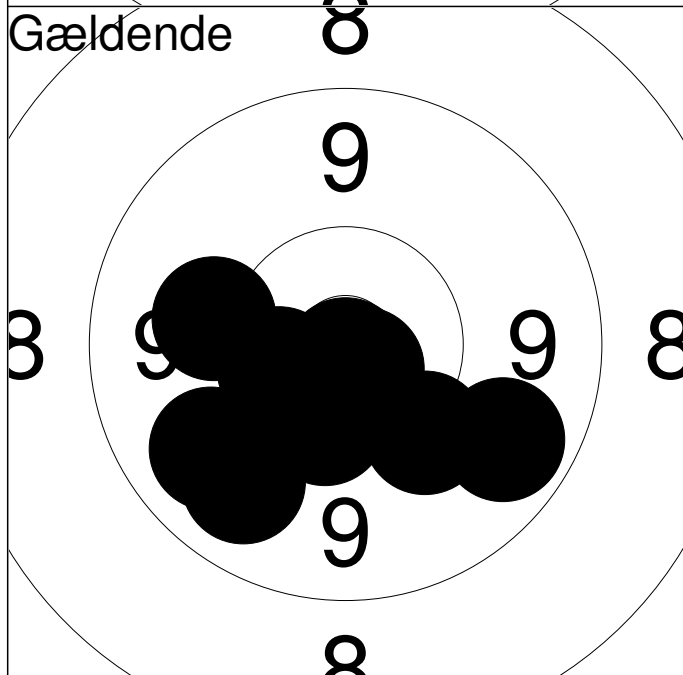

1:	*10.7	↓
2:	*10.8	↓
3:	*10.5	←
4:	10.2	↙
5:	10.1	←
6:	9.8	↙
7:	10.4	↓
8:	9.7	↘
9:	9.8	↙
10:	*10.8	↓
Serie		97.0
Total		97.0

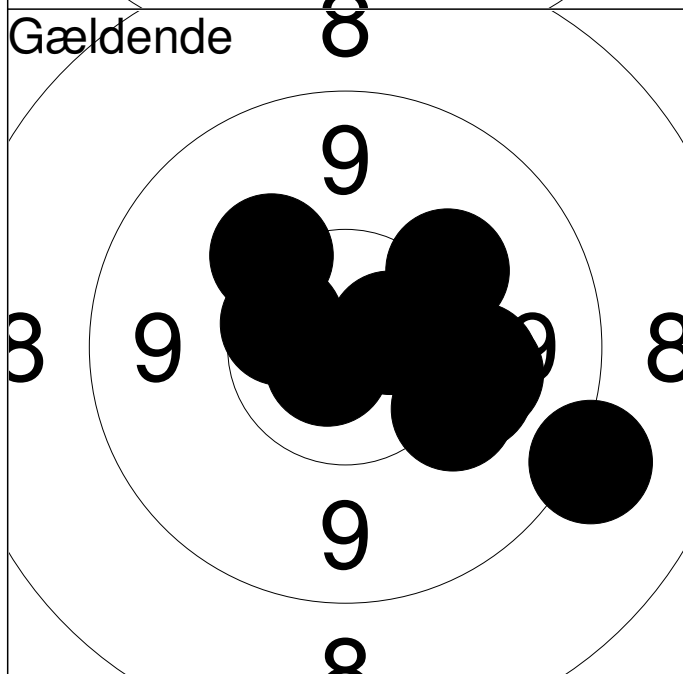

11:	10.1	→
12:	10.1	↘
13:	*10.5	↗
14:	10.0	→
15:	*10.8	↙
16:	10.1	→
17:	*10.6	→
18:	9.1	↘
19:	10.2	↗
20:	10.1	↗
Serie		99.0
Total		196.0